

751281: Suzuki Grand Vitara 2005 -

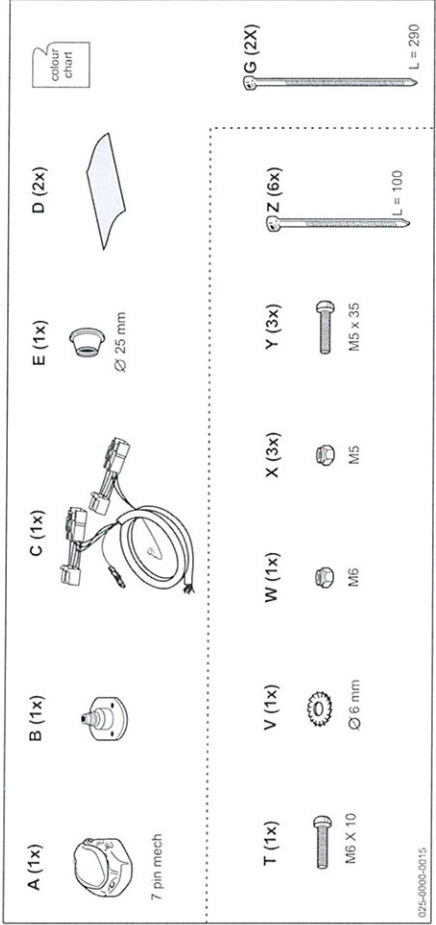

025-0000-0015

NL	Algemene richtlijnen voor montage	ES	Directorios generales para la asamblea
DK	Almene oplysninger	I	Istruzioni generali
D	Allgemeine Hinweise zur Montage-Erleichterung	GR	Γενικές οδηγίες για τη συνέλευση
FR	Directives générales pour faciliter le montage	HUN	Használati útmutató
S	Almänna Instruktioner	SK	Užívateľská príručka
GB	General instructions	PL	Ogólne polecenia
SF	Yleistia ohjeita	PU	Directrices orientadoras gerais para o conjunto

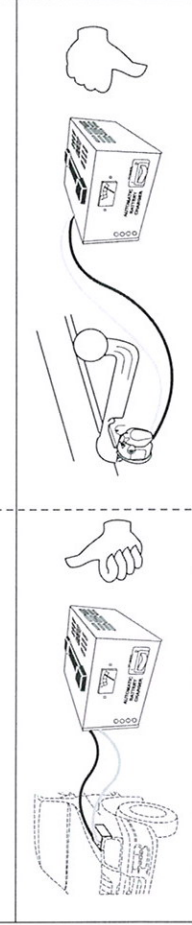
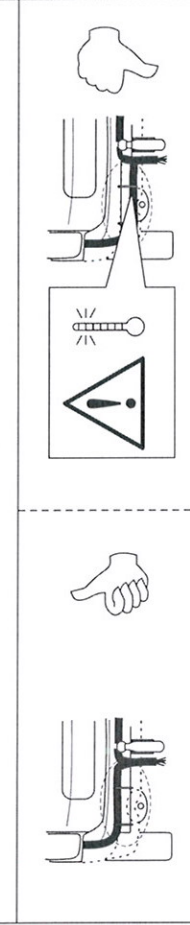
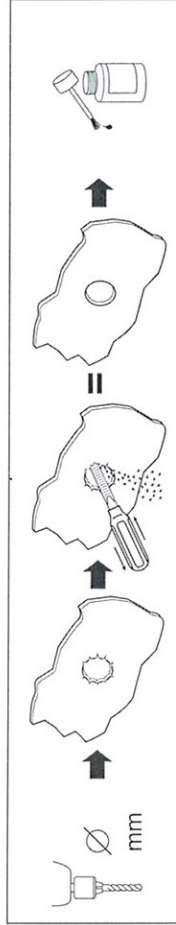

ROUTING

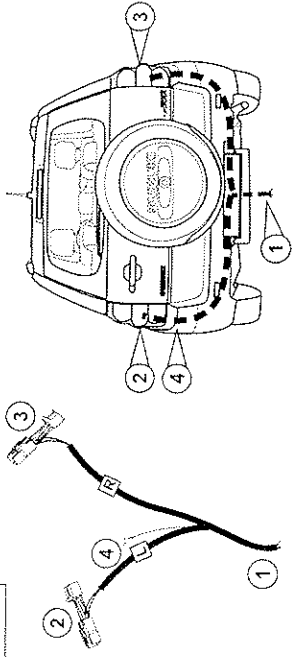

WORKSHOP MANUAL

1

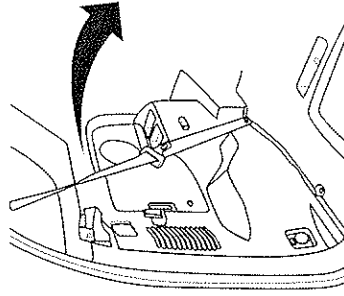
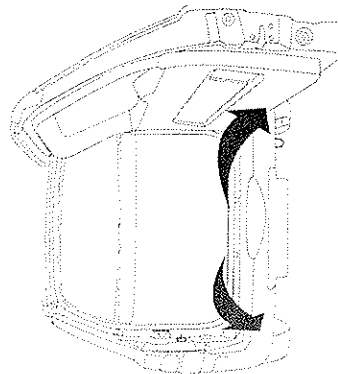

2

3

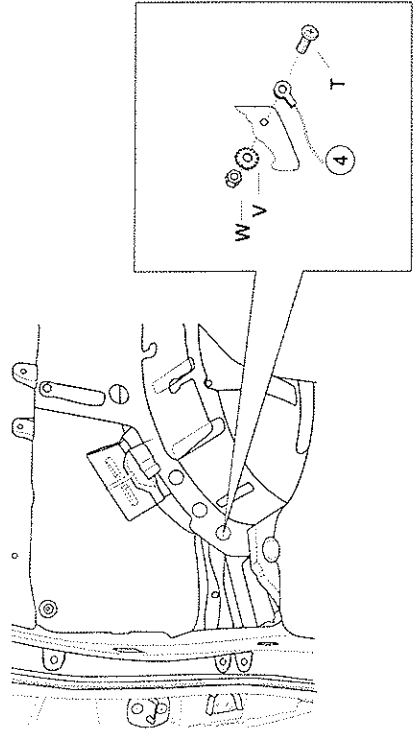

4 5 DOOR ONLY

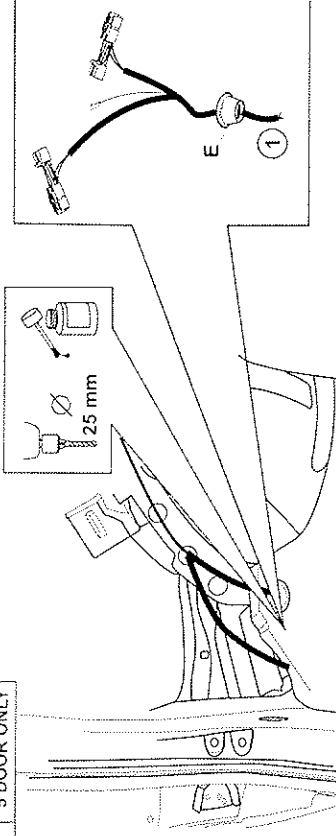

4 3 DOOR ONLY

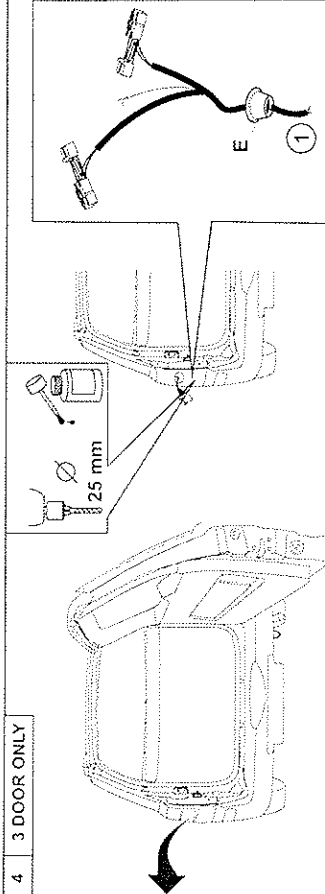

5

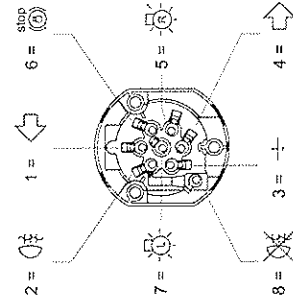

2 = Ø 25

1 = Ø 25

6 = Ø 25

5 = Ø 25

4 = Ø 25

3 = Ø 25

7 = Ø 25

8 = Ø 25

5 = Ø 25

4 = Ø 25

3 = Ø 25

2 = Ø 25

1 = Ø 25

6 = Ø 25

5 = Ø 25

4 = Ø 25

3 = Ø 25

2 = Ø 25

1 = Ø 25

6 = Ø 25

5 = Ø 25

4 = Ø 25

3 = Ø 25

2 = Ø 25

1 = Ø 25

6 = Ø 25

5 = Ø 25

4 = Ø 25

3 = Ø 25

2 = Ø 25

1 = Ø 25

6 = Ø 25

5 = Ø 25

4 = Ø 25

3 = Ø 25

2 = Ø 25

1 = Ø 25

6 = Ø 25

5 = Ø 25

4 = Ø 25

3 = Ø 25

2 = Ø 25

1 = Ø 25

6 = Ø 25

5 = Ø 25

4 = Ø 25

3 = Ø 25

2 = Ø 25

1 = Ø 25

6 = Ø 25

5 = Ø 25

4 = Ø 25

3 = Ø 25

2 = Ø 25

1 = Ø 25

6 = Ø 25

5 = Ø 25

4 = Ø 25

3 = Ø 25

2 = Ø 25

1 = Ø 25

6 = Ø 25

5 = Ø 25

4 = Ø 25

3 = Ø 25

2 = Ø 25

1 = Ø 25

6 = Ø 25

5 = Ø 25

4 = Ø 25

3 = Ø 25

2 = Ø 25

1 = Ø 25

6 = Ø 25

5 = Ø 25

4 = Ø 25

3 = Ø 25

2 = Ø 25

1 = Ø 25

6 = Ø 25

5 = Ø 25

4 = Ø 25

3 = Ø 25

2 = Ø 25

1 = Ø 25

6 = Ø 25

5 = Ø 25

4 = Ø 25

3 = Ø 25

2 = Ø 25

1 = Ø 25

6 = Ø 25

5 = Ø 25

4 = Ø 25

3 = Ø 25

2 = Ø 25

1 = Ø 25

6 = Ø 25

5 = Ø 25

4 = Ø 25

3 = Ø 25

2 = Ø 25

1 = Ø 25

6 = Ø 25

5 = Ø 25

4 = Ø 25

3 = Ø 25

2 = Ø 25

1 = Ø 25

6 = Ø 25

5 = Ø 25

4 = Ø 25

3 = Ø 25

2 = Ø 25

1 = Ø 25

6 = Ø 25

5 = Ø 25

4 = Ø 25

3 = Ø 25

2 = Ø 25

1 = Ø 25

6 = Ø 25

5 = Ø 25

4 = Ø 25

3 = Ø 25

2 = Ø 25

1 = Ø 25

6 = Ø 25

5 = Ø 25

4 = Ø 25

3 = Ø 25

2 = Ø 25

1 = Ø 25

6 = Ø 25

5 = Ø 25

4 = Ø 25

3 = Ø 25

2 = Ø 25

1 = Ø 25

6 = Ø 25

5 = Ø 25

4 = Ø 25

3 = Ø 25

2 = Ø 25

1 = Ø 25

6 = Ø 25

5 = Ø 25

4 = Ø 25

3 = Ø 25

2 = Ø 25

1 = Ø 25

6 = Ø 25

5 = Ø 25

4 = Ø 25

3 = Ø 25

2 = Ø 25

1 = Ø 25

6 = Ø 25

5 = Ø 25

4 = Ø 25

3 = Ø 25

2 = Ø 25

1 = Ø 25

6 = Ø 25

5 = Ø 25

4 = Ø 25

3 = Ø 25

2 = Ø 25

1 = Ø 25

6 = Ø 25

5 = Ø 25

4 = Ø 25

3 = Ø 25

2 = Ø 25

1 = Ø 25

6 = Ø 25

5 = Ø 25

4 = Ø 25

3 = Ø 25

2 = Ø 25

1 = Ø 25

6 = Ø 25

5 = Ø 25

4 = Ø 25

3 = Ø 25

2 = Ø 25

1 = Ø 25

6 = Ø 25

5 = Ø 25

4 = Ø 25

3 = Ø 25

2 = Ø 25

1 = Ø 25

6 = Ø 25

5 = Ø 25

4 = Ø 25

3 = Ø 25

2 = Ø 25

1 = Ø 25

6 = Ø 25

5 = Ø 25

4 = Ø 25

3 = Ø 25

2 = Ø 25

1 = Ø 25

6 = Ø 25

5 = Ø 25

4 = Ø 25

3 = Ø 25

2 = Ø 25

1 = Ø 25

6 = Ø 25

5 = Ø 25

4 = Ø 25

3 = Ø 25

2 = Ø 25

1 = Ø 25

6 = Ø 25

5 = Ø 25

4 = Ø 25

3 = Ø 25

2 = Ø 25

1 = Ø 25

6 = Ø 25

5 = Ø 25

4 = Ø 25

3 = Ø 25

2 = Ø 25

1 = Ø 25

6 = Ø 25

5 = Ø 25

4 = Ø 25

3 = Ø 25

2 = Ø 25

1 = Ø 25

6 = Ø 25

5 = Ø 25

4 = Ø 25

3 = Ø 25

2 = Ø 25

1 = Ø 25

6 = Ø 25

5 = Ø 25

4 = Ø 25

3 = Ø 25

2 = Ø 25

1 = Ø 25

6 = Ø 25

5 = Ø 25

4 = Ø 25

3 = Ø 25

2 = Ø 25

1 = Ø 25

6 = Ø 25

5 = Ø 25

4 = Ø 25

3 = Ø 25

2 = Ø 25

1 = Ø 25

6 = Ø 25

5 = Ø 25

4 = Ø 25

3 = Ø 25

2 = Ø 25

1 = Ø 25

6 = Ø 25

5 = Ø 25

4 = Ø 25

3 = Ø 25

2 = Ø 25

1 = Ø 25

6 = Ø 25

</