

# Kit 1371

TOYOTA Avanza, 5-dr MPV, 04-

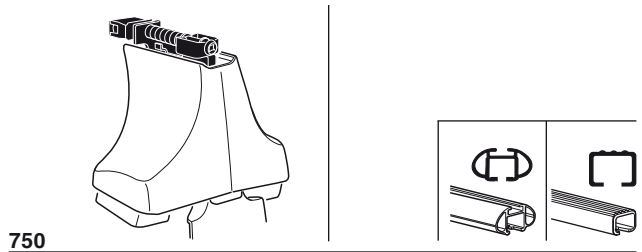

**Kit**

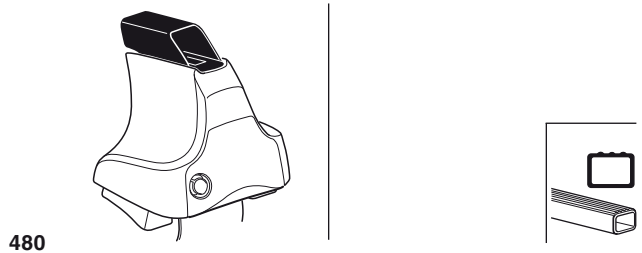
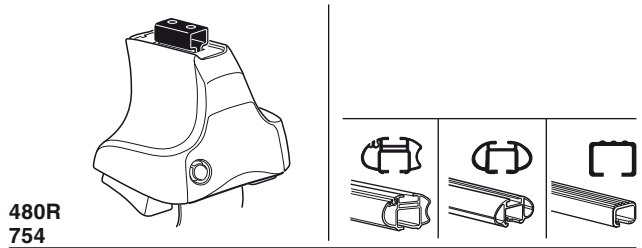
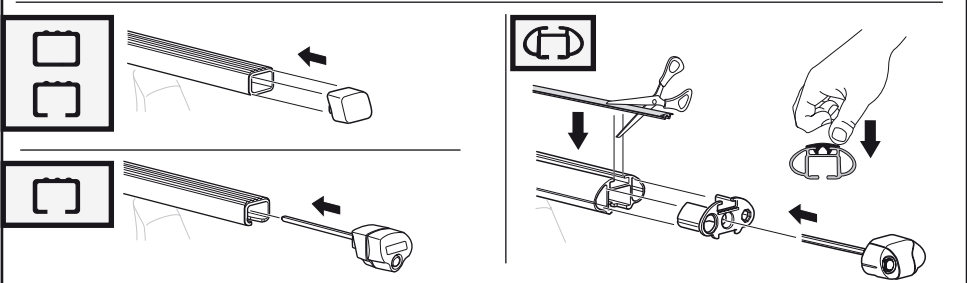
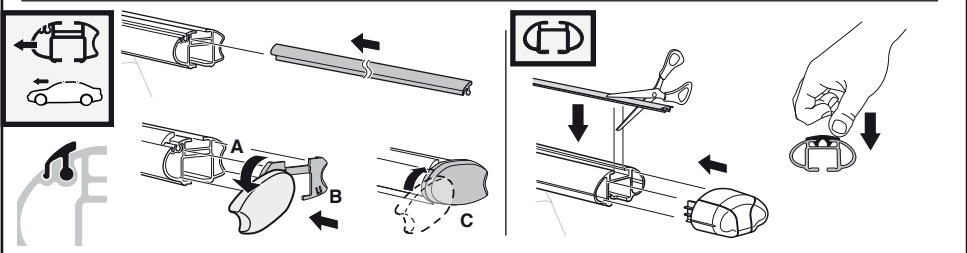
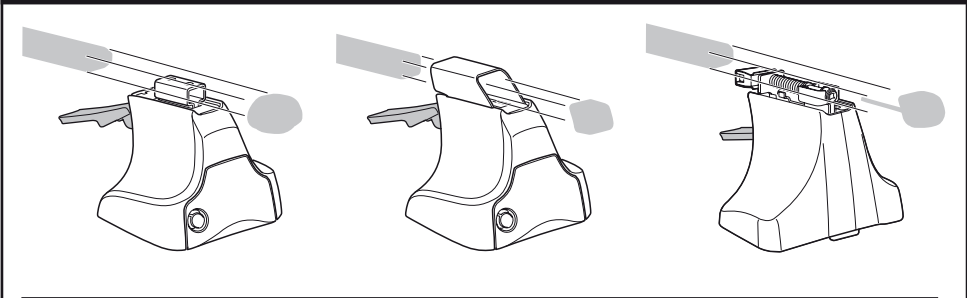
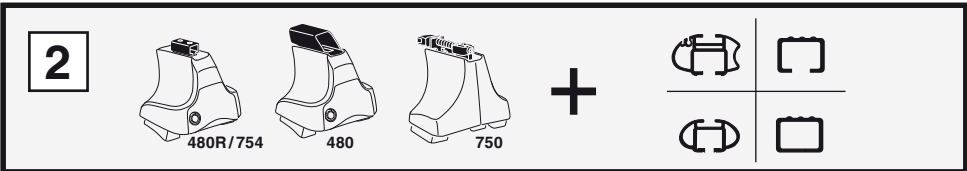
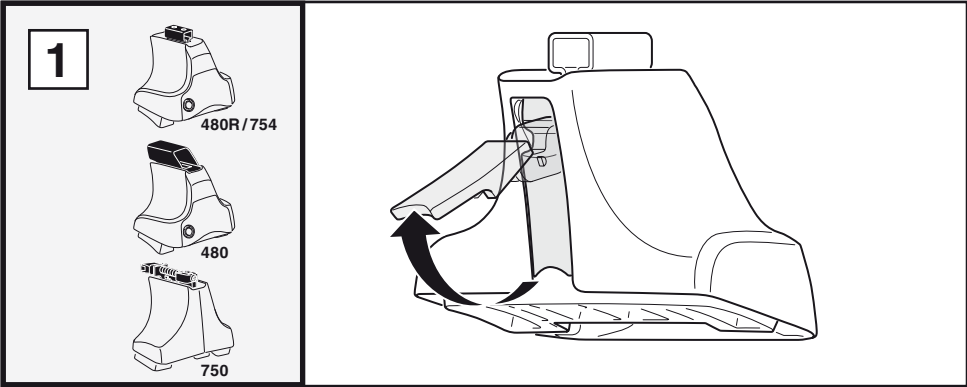

**3**

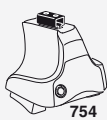

754

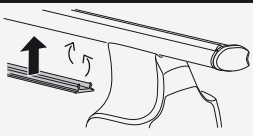
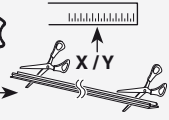

750

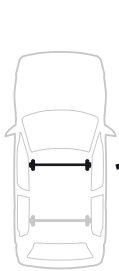

**1**

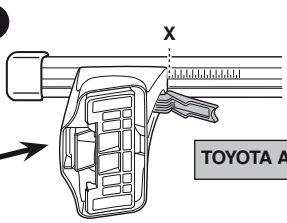

**2**

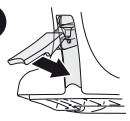

	X
TOYOTA Avanza, 5-dr MPV, 04-	33,5



**1**

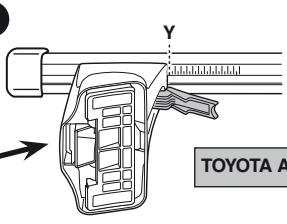

**2**

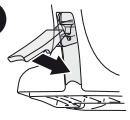

	Y
TOYOTA Avanza, 5-dr MPV, 04-	31,5



480R



480

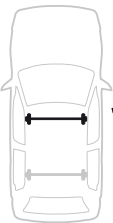

**1**

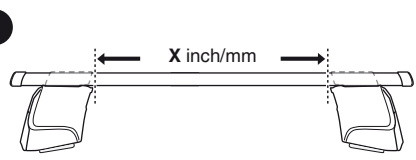

**2**



	X inch	X mm
TOYOTA Avanza, 5-dr MPV, 04-	38 <sup>7</sup> / <sub>8</sub> "	986 mm



**1**

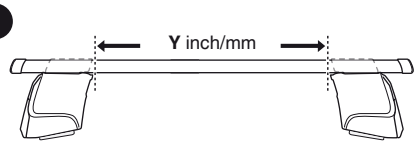

**2**



	Y inch	Y mm
TOYOTA Avanza, 5-dr MPV, 04-	48 "	966 mm

4

TOYOTA Avanza, 5-dr MPV, 04-

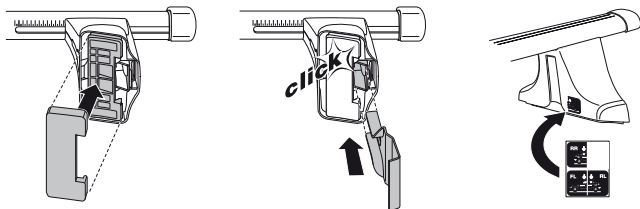
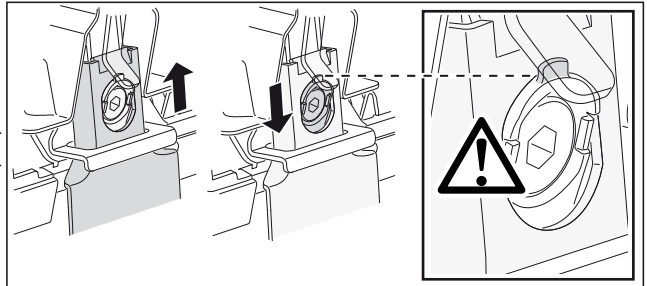
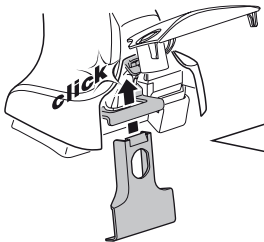
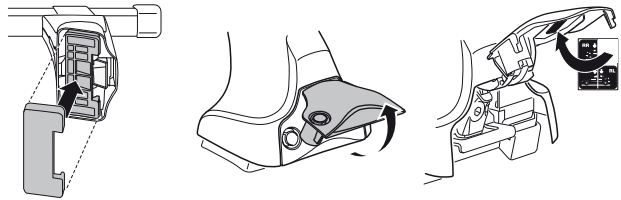
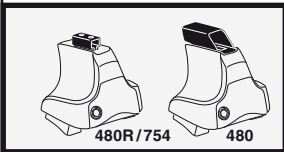
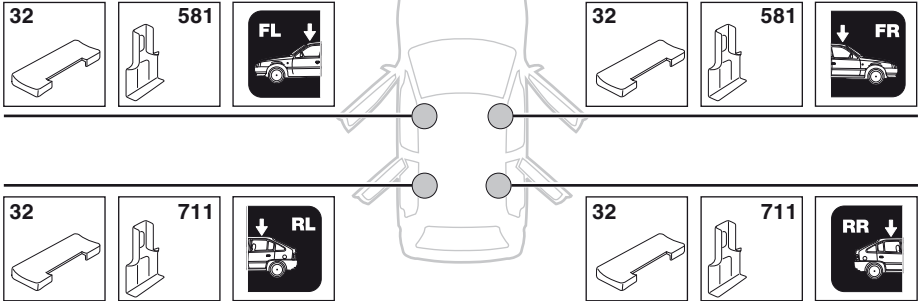

5

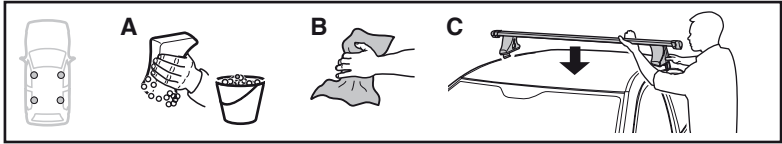

	X mm	Y mm	X inch	Y inch
TOYOTA Avanza, 5-dr MPV, 04-	300 mm	700 mm	11 3/4"	27 1/2"

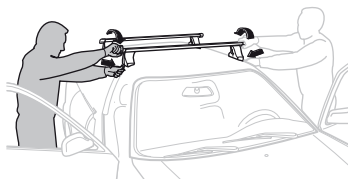
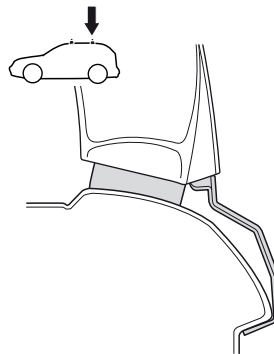
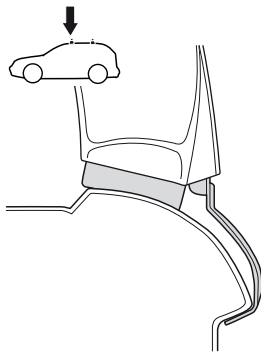
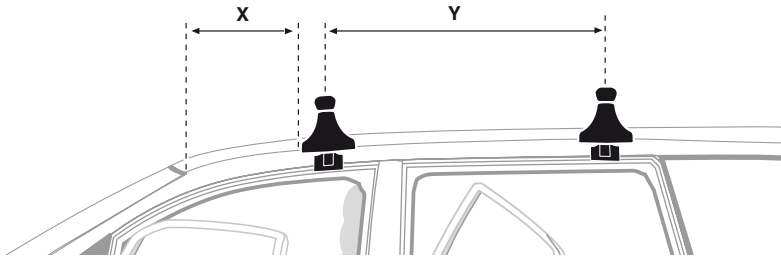

**GB/US** Tighten alternately

**D** Die Schrauben abwechselnd anziehen

**F** Serrer alternativement chaque côté

**NL** Afwisselend aan de linker- en de rechterkant aandraaien

**I** Alternare il serraggio delle viti

**E** Apertar alternativamente

**PT** Aperte alternadamente

**S** Dra åt växelvis

**FIN** Kierrä vuorotellen

**EST** Pinguldage vaheldumisi

**LAT** Pielieciet pamišus

**LIT** Užsukinėkite pakaitomis

**PL** Śruby dokręcaj naprzemiennie

**RU** Затягивайте попеременно

**CZ** Pokręťta bagażnika dokręcaj dokręcaj naprzemiennie.

**SK** Doťahujte striedavo

**SLO** Privijajte izmenično.

**HR** Naizmjenično zategnite

**HU** Egymástól függetlenül szorítandó

**GR** Σφιγγετε εναλλάξ

**TR** Dönüşümlü sıkın

**中文** 交替拧紧

**한국어** 번갈아 가며 조이십시오.

**日本語** 交互に締め付けてください。

**ไทย** ชั้้นโน้แบบสลับ

6



480R/754



480

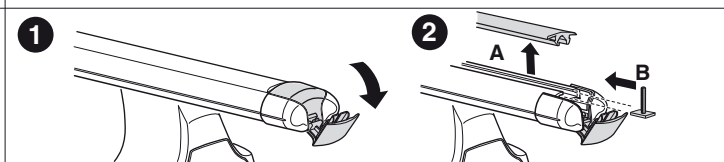
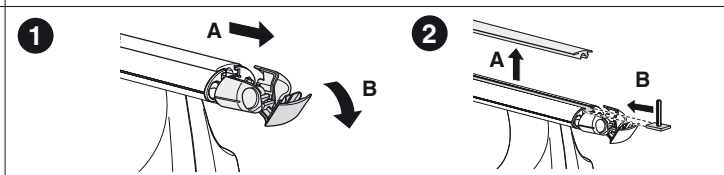
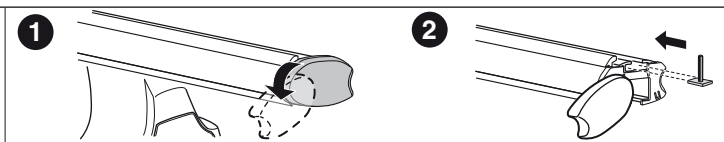
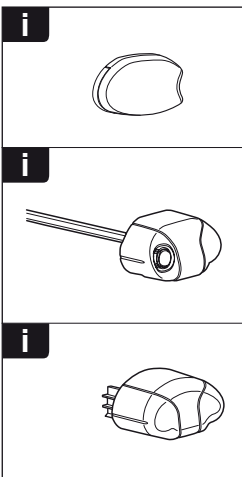
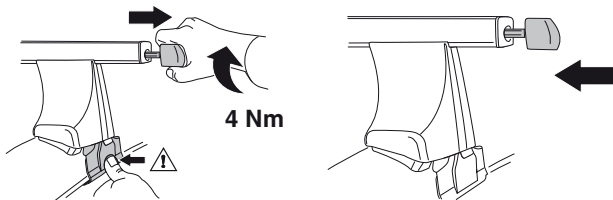
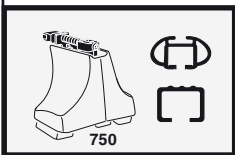
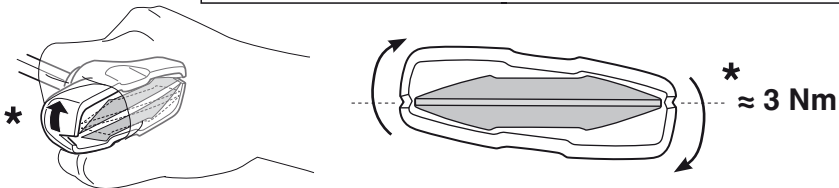
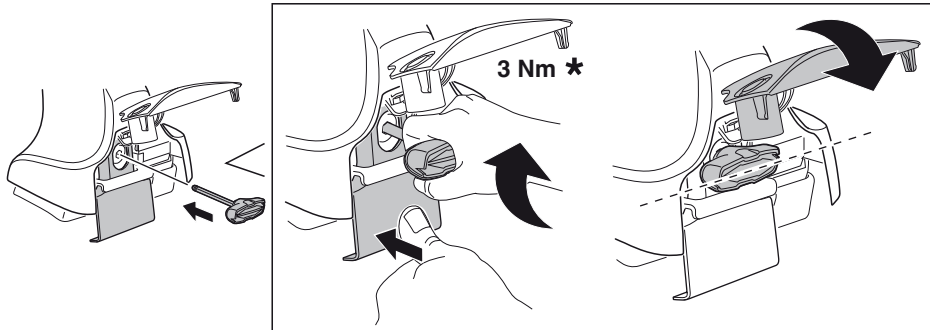

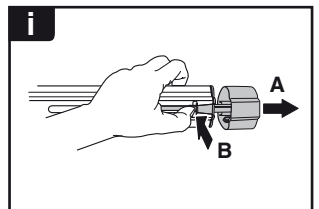
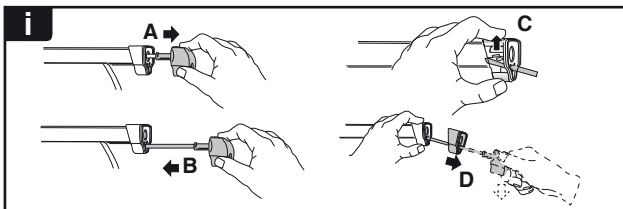
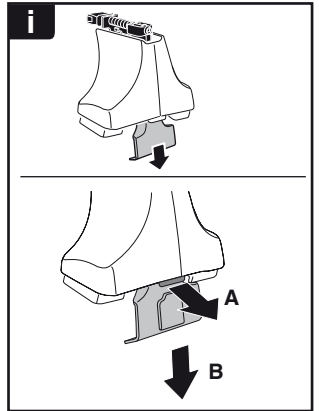
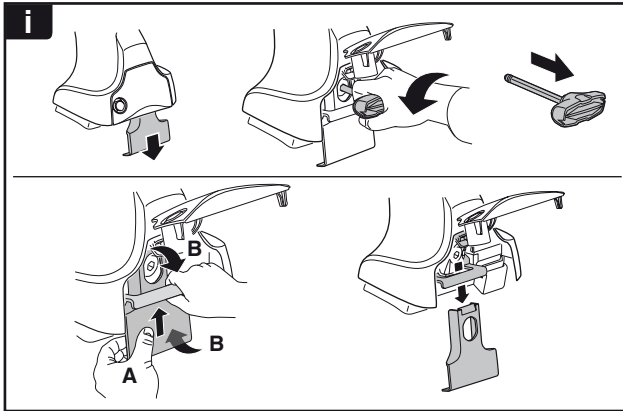
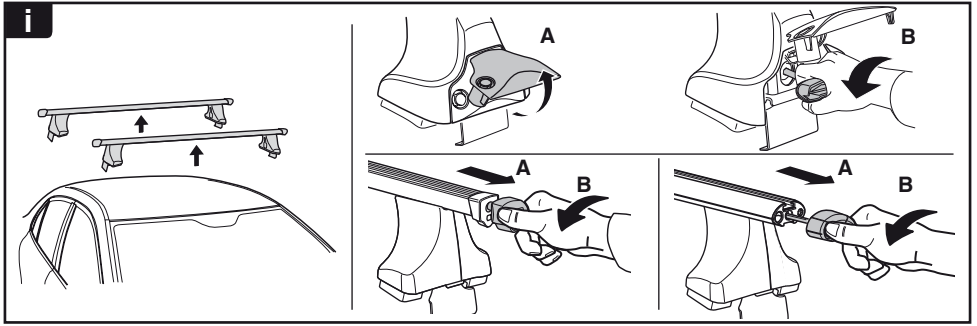

**THULE**  
SWEDEN  
**ONE  
KEY  
SYSTEM**

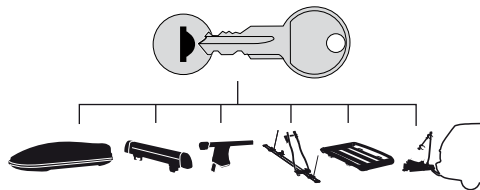

- 544 (x4)
- 596 (x6)
- 588 (x8)
- NA 510 (x10)
- EUR 452 (x12)
- ASIA

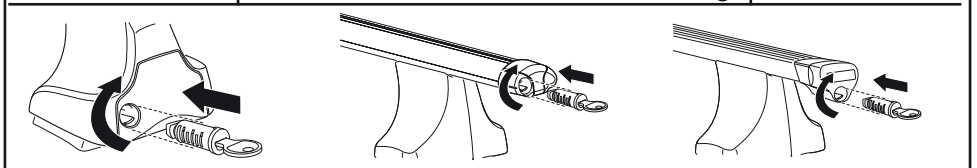

WW ▶ Thule Sweden AB, Box 69, 330 33 Hillerstorp, SWEDEN  
NA ▶ Thule Inc., 42 Silvermine Road, Seymour, Connecticut 06483, USA

info@thule.com  
customer.service@thule.com

www.thule.com