











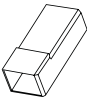
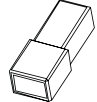

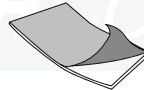
## KIA CEE'D 5DRS, 10/2009-02/2012

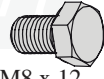
with PDC cut out

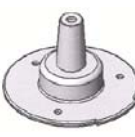
7-pol

Nr: 35164

Suitable for models without Break light control

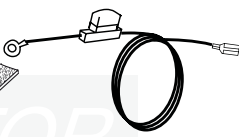
1x  Art.no. 3500-0050	1x  Art.no. 3716	1x  Art.no. 3717	1x  Art.no. 3516	1x  M8 Art.no. 1063	50cm  Art.no. 3584	6x L=140  Art.no. 6079	6x L=186  Art.no. 6081	1x  M8 x 12 Art.no. 1094
1x  Art.no.10000	1x  Art.no.4093	3x  M5 x 35 Art.no. 1031	3x  Art.no. 1091	3x  M5 Art.no. 1071	4cm  Art.no. 3530	4cm  Art.no. 3531	1x  9700-0082	

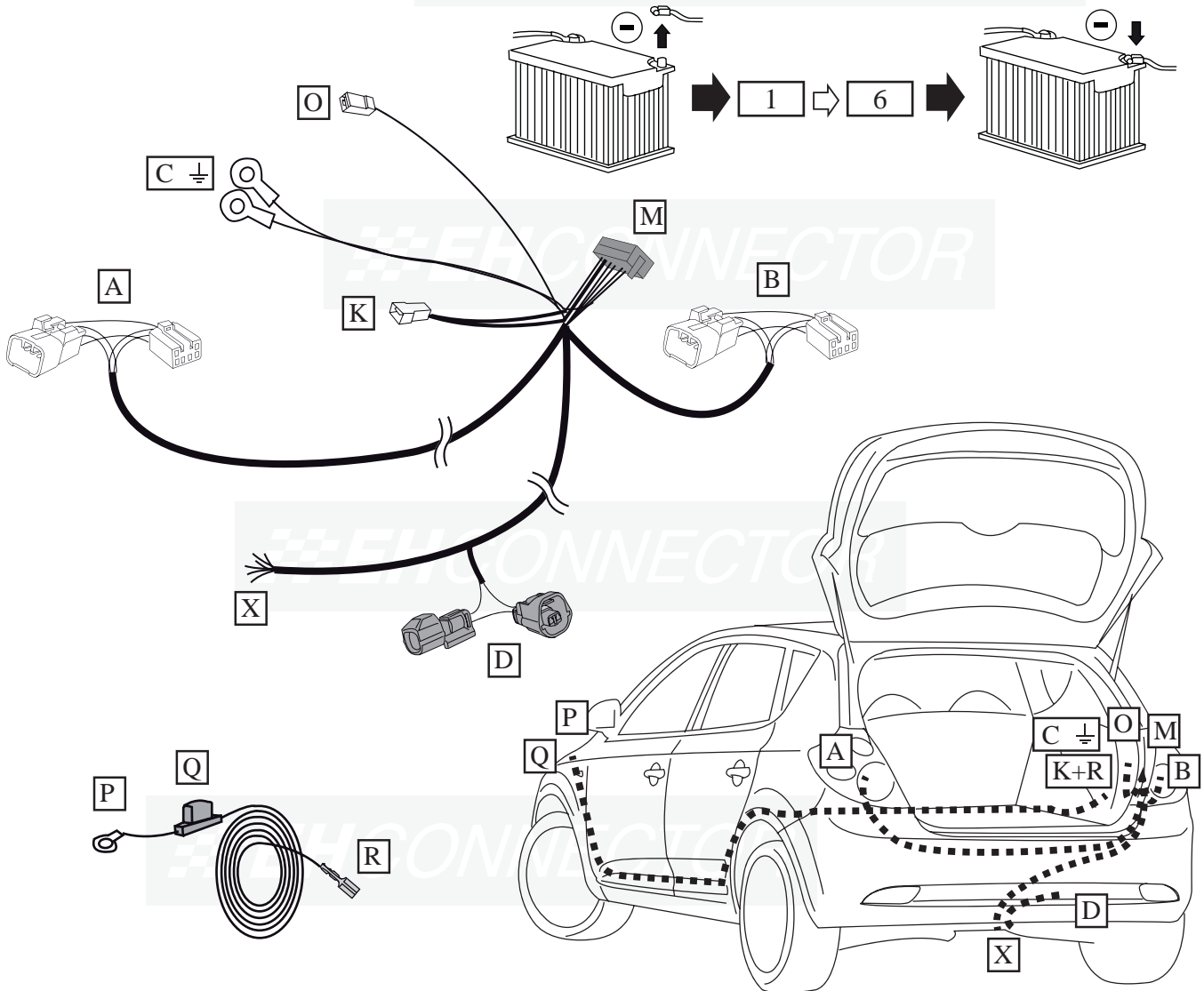

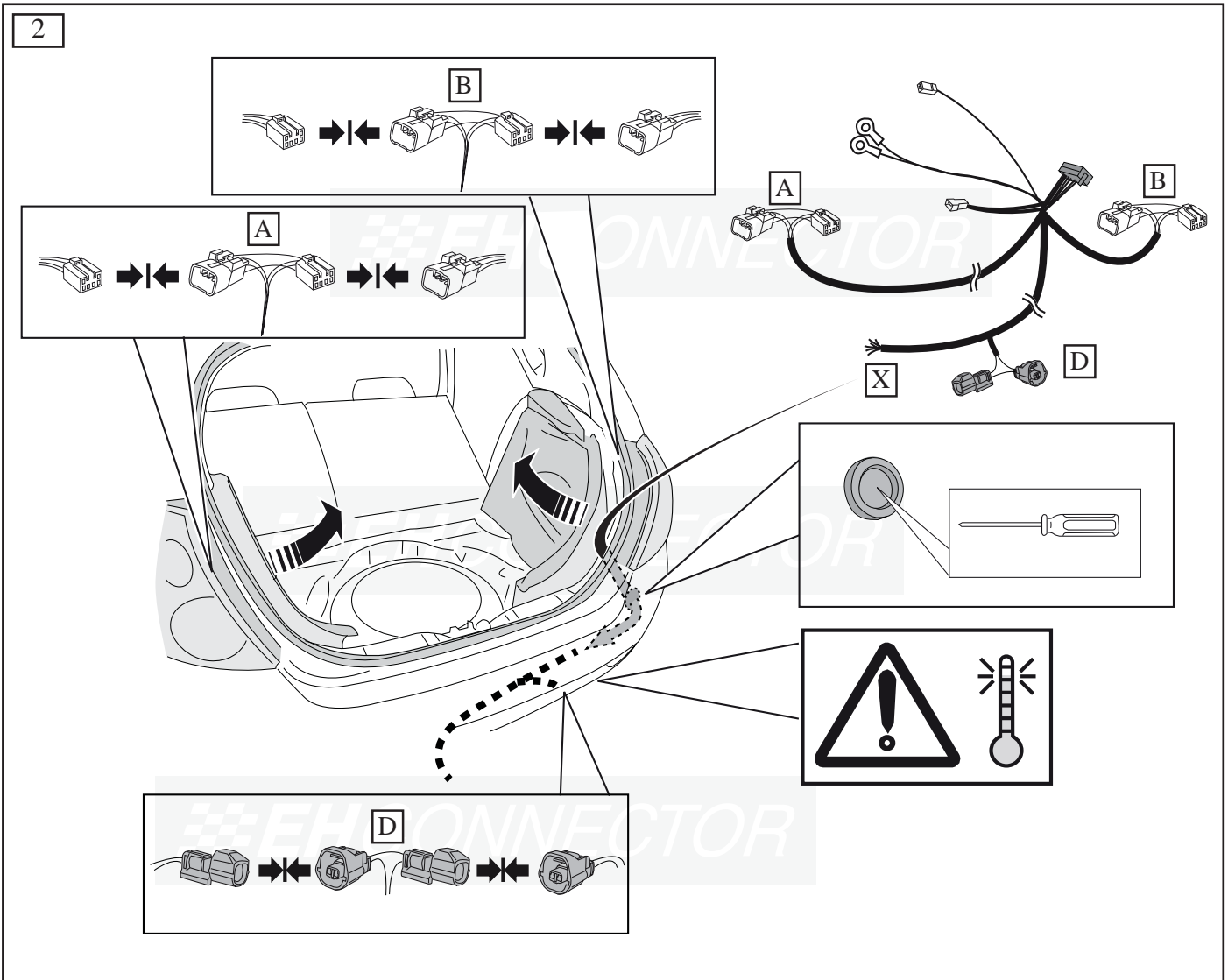
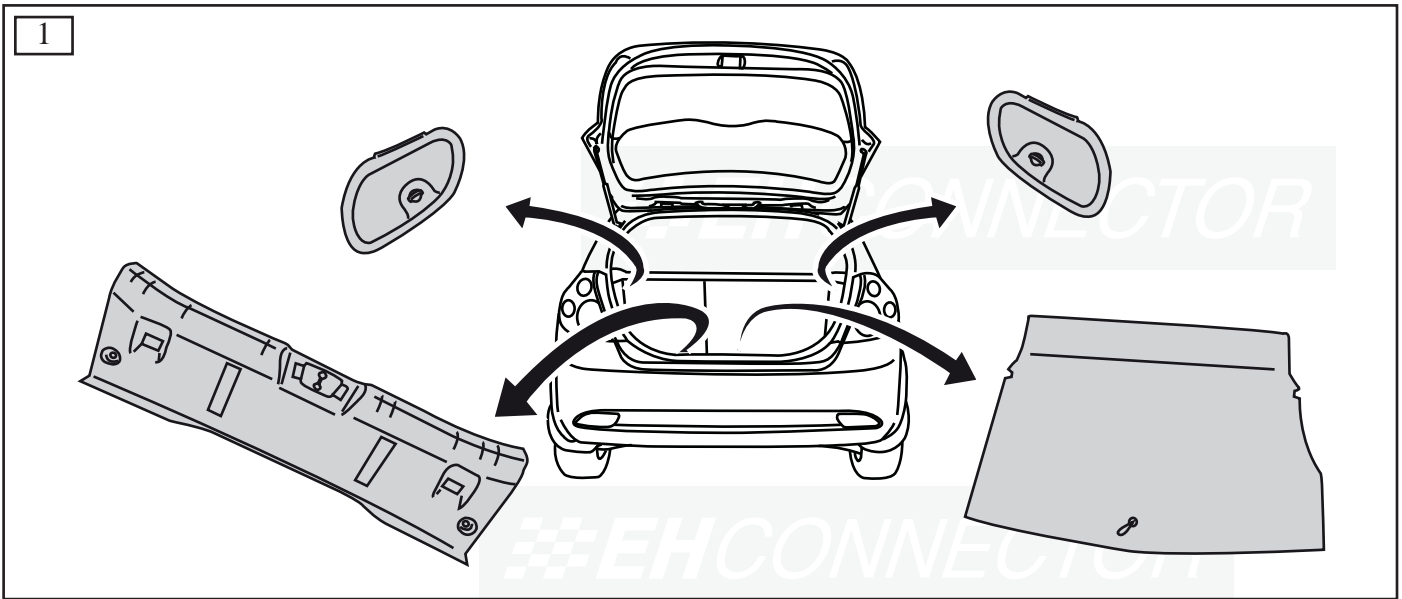

3

### OPTION 1

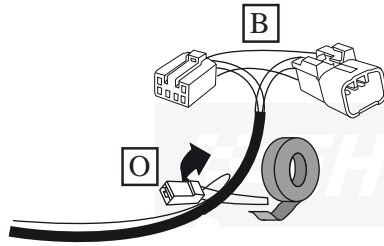

### OPTION 2

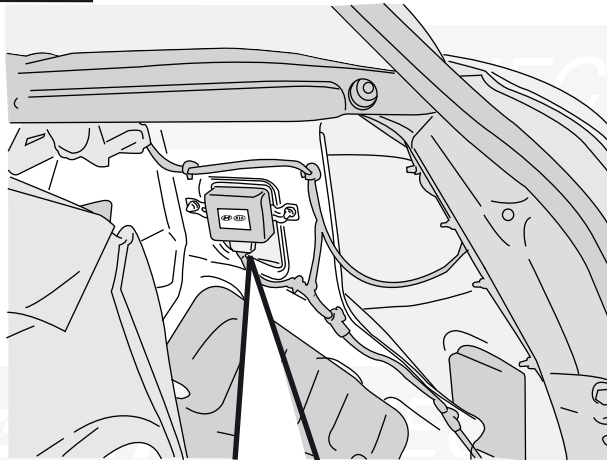
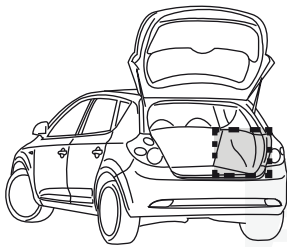
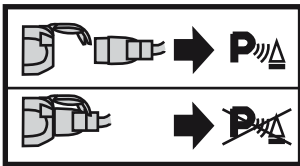
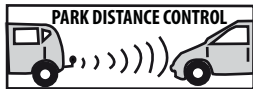

red  
röd  
rød  
punainen  
czerwony

1. Stripping the cable with pliers.
2. Inserting the cable into the connector and securing it with a screwdriver.
3. Connecting the cable to the car's wiring harness.

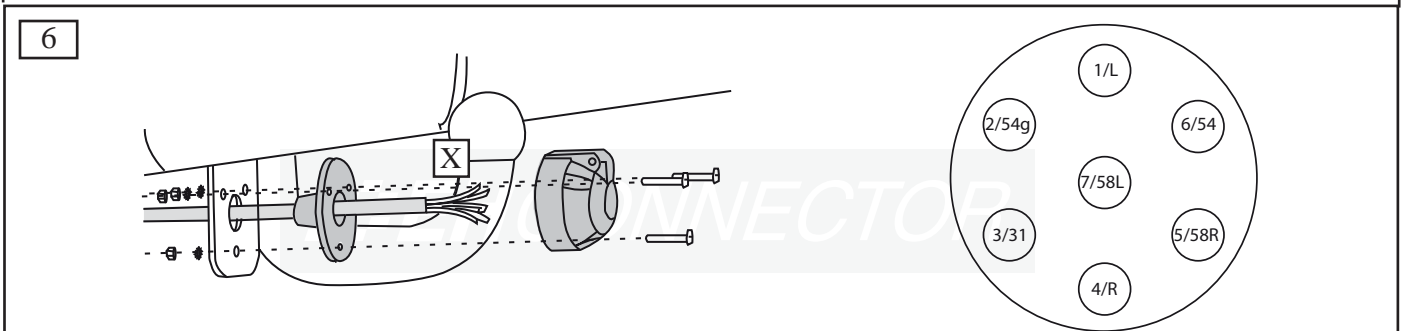
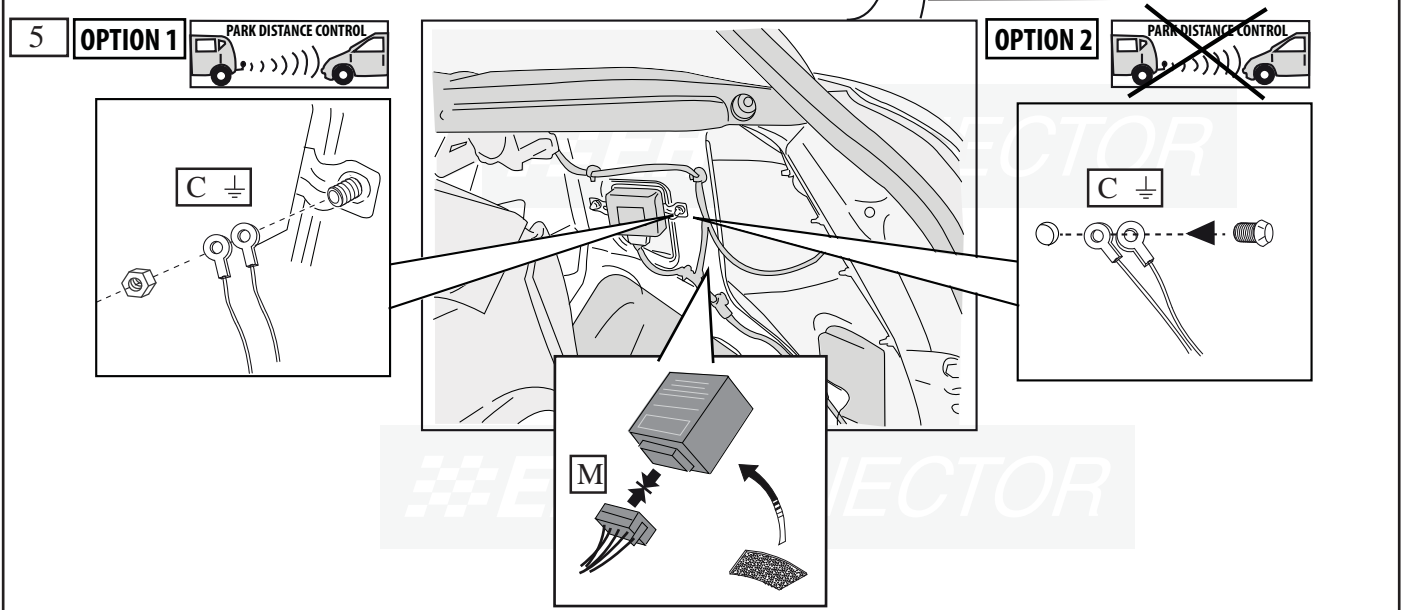
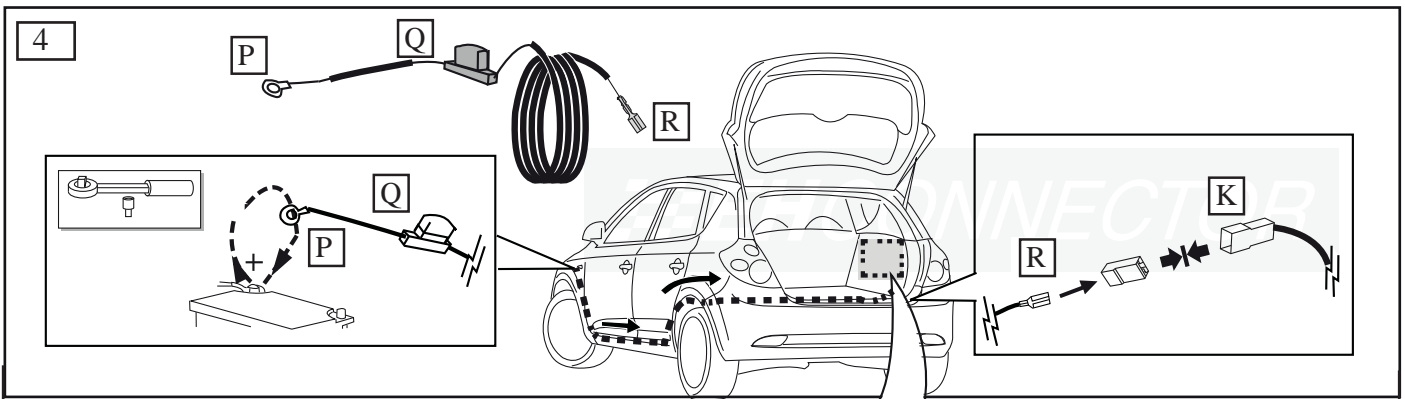

P-MAX		GB	S	N	DK	FIN	POL
21W	↶	1/L	yellow	gul	gul	gul	żółty
2x21W	⊕	2/54g	blue	blå	blå	sininen	niebieski
	⊥	3/31	white	vit	hvit	valkoinen	biały
21W	↷	4/R	green	grön	grønn	grøn	zielony
52W	☀	5/58R	brown	brun	brun	brun	brązowy
2x21W	⊘	6/54	red	röd	rød	punainen	czerwony
52W	☀	7/58L	black	svart	sort	sort	czarny