

Kit 1171

JAGUAR S-type, 4-dr Sedan, 99-03, 04-07 / *00-03, 04-08

*North America

480R
754

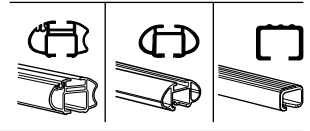
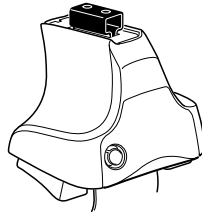

480

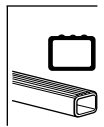
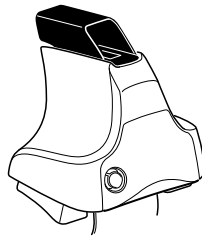

750

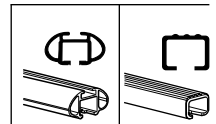
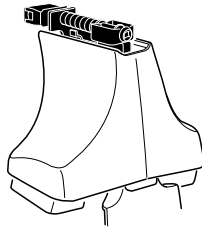

480R/754 x1
480 x1
750 x1

x4
 x4
 x4
 x4
 x4
 x4

x2 x2 x2 x4	x2	x2 x2 x4 x4	x2 x2 x2	x2
----------------------	----	----------------------	----------------	----

x4
 x2
 x2
 x4
 x4
 x1

Kit



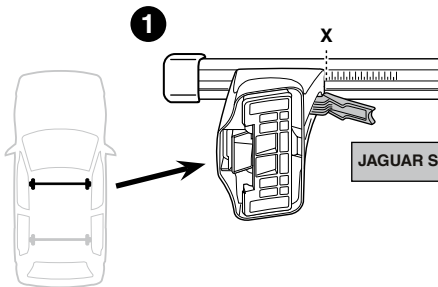

	X
JAGUAR S-type, 4-dr Sedan, 99-03, 04-07 / *00-03, 04-08	31

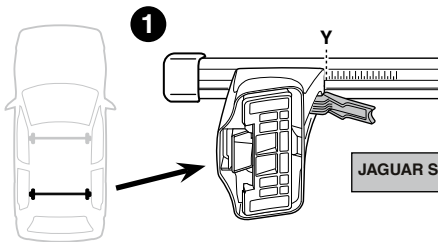
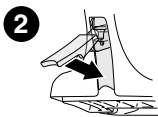

	Y
JAGUAR S-type, 4-dr Sedan, 99-03, 04-07 / *00-03, 04-08	34,5

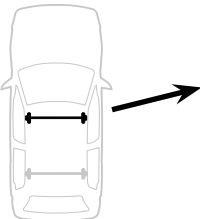

	X inch	X mm
JAGUAR S-type, 4-dr Sedan, 99-03, 04-07 / *00-03, 04-08	37 ⁷ / ₈ "	961 mm

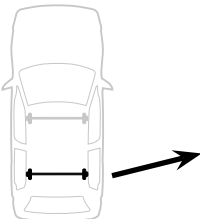

	Y inch	Y mm
JAGUAR S-type, 4-dr Sedan, 99-03, 04-07 / *00-03, 04-08	39 ¹ / ₄ "	996 mm

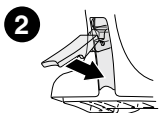

4

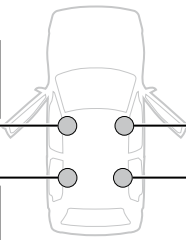
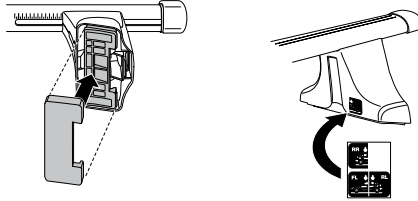
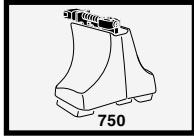
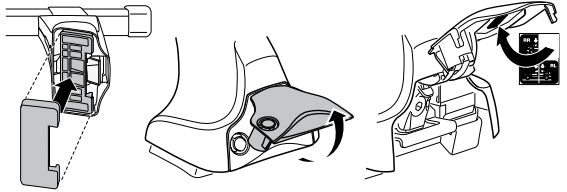
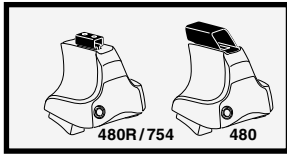

5

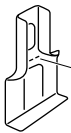
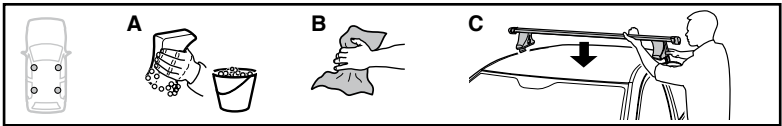

x 4

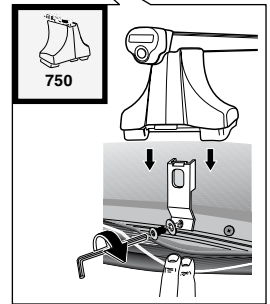
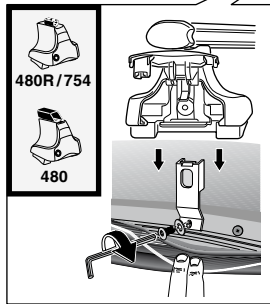
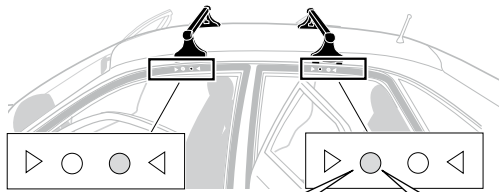
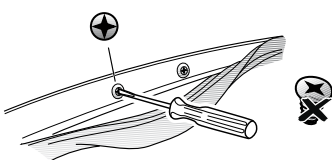

6

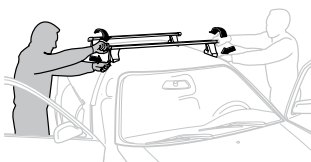
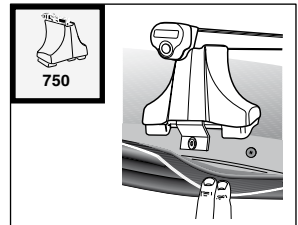
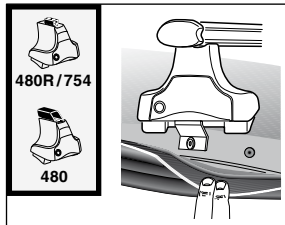
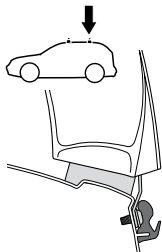
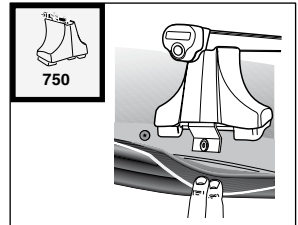
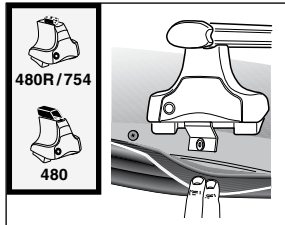
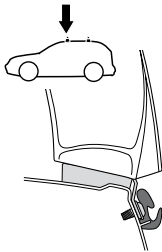
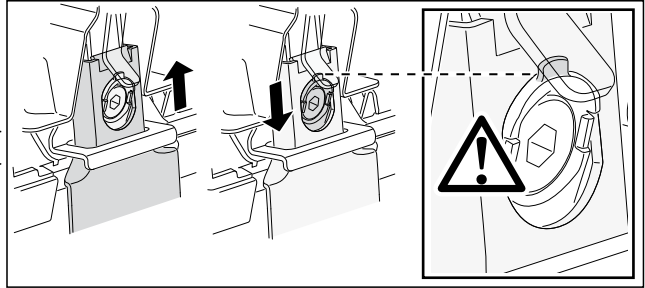
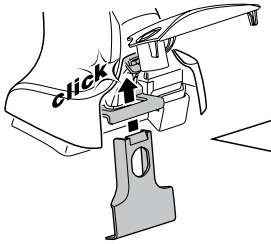

GB/US Tighten alternately
D Die Schrauben abwechselnd anziehen
F Serrer alternativement chaque côté
NL Afwisselend aan de linker- en de rechterkant aandraaien
I Alternare il serraggio delle viti
E Apretar alternativamente
PT Aperte alternadamente
S Dra åt växelvis
FIN Kierrä vuorotellen
EST Pinguldage vaheldumisi
LAT Pielieciet pamišus
LIT Užsukinėkite pakaitomis
PL Śruby dokręcaj naprzemiennie
RU Затягивайте попеременно

CZ Pokręťta багаžníka dokręcaj dokręcaj naprzemiennie.
SK Doťahujte striedavo
SLO Privijajte izmenično.
HR Naizmjenično zategnite
HU Egymástól függetlenül szorítandó
GR Σφιγγετε εναλλάξ
TR Dönüşümlü sıkın
中文 交替拧紧
한국어 번갈아 가며 조이십시오.
日本語 交互に締め付けてください。
ไทย ชับในแบบสลับ

7

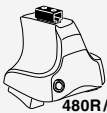

480R/754



480

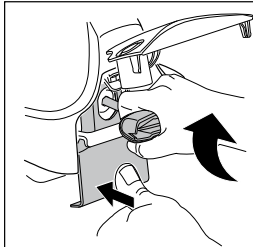
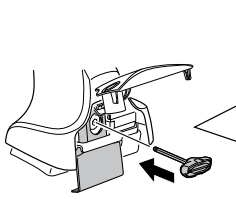
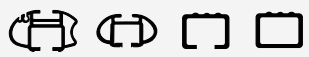

*
3 Nm

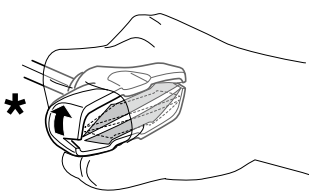
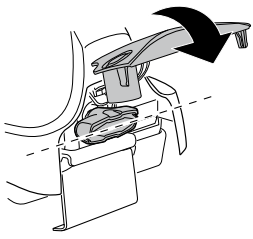

*

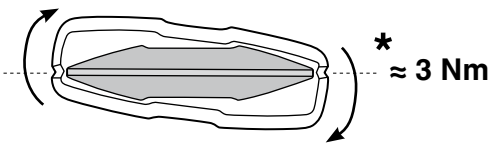

*
≈ 3 Nm

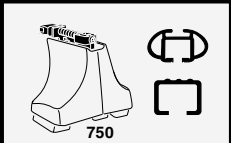
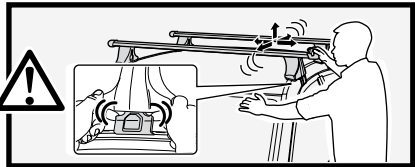

750

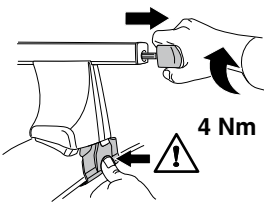

4 Nm

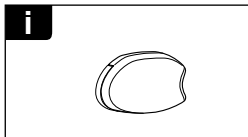
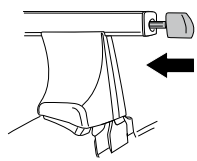

i

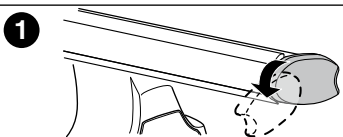

1

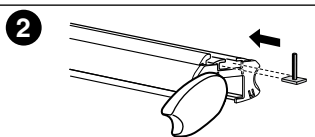

2

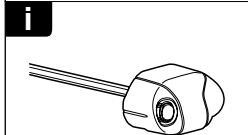

i

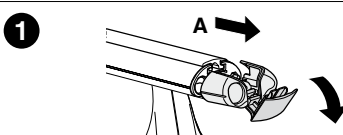

1

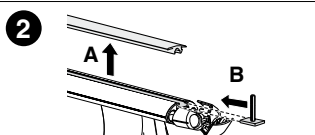

2

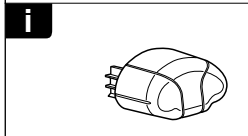

i

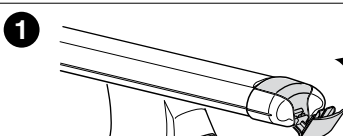

1

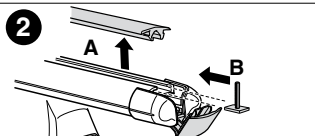

2

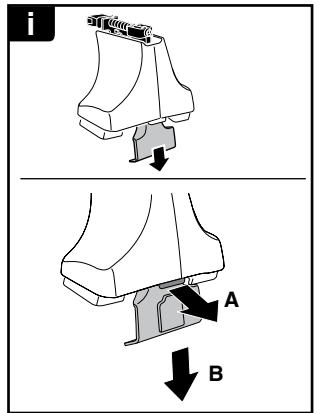
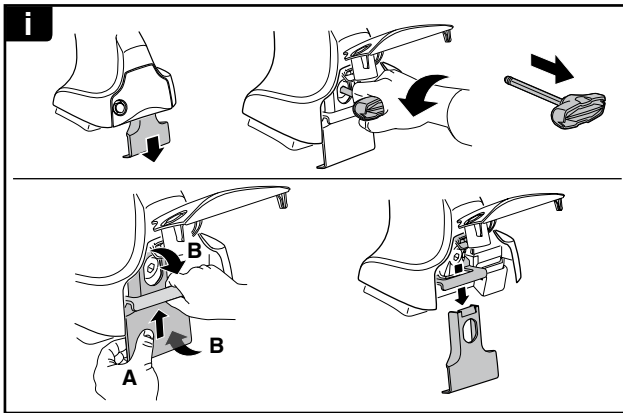
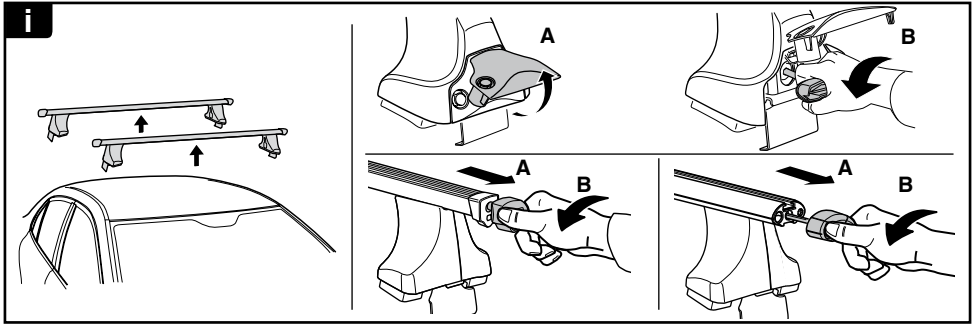

THULE
SWEDEN
**ONE
KEY
SYSTEM**



- 544 (x4)
- 596 (x6)
- 588 (x8)
- NA 510 (x10)
- EUR 452 (x12)
- ASIA

