

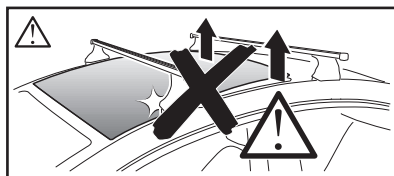

Thule XT Kit 3176

> Instructions

MERCEDES G-Class, 5-dr SUV, 19-



This kit is only for vehicles with fixpoint mounting.

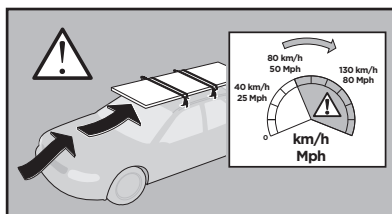
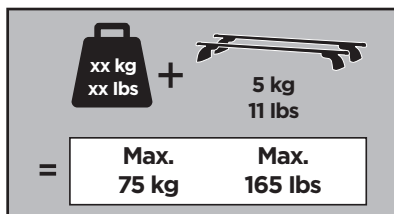
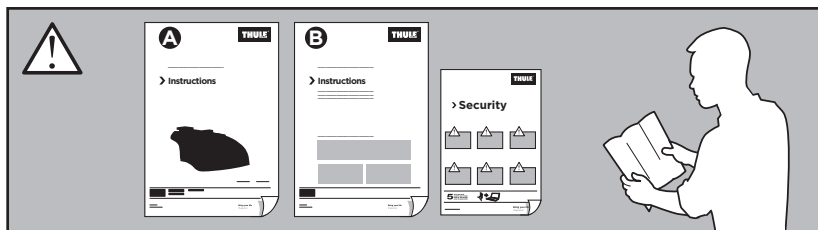

ISO 11154-E

183176

C.20190711
509-3176-01

Bring your life
thule.com

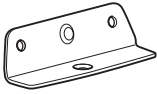

17 x4

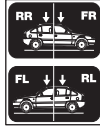

x1

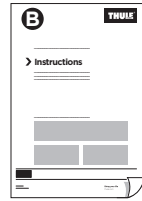

x1

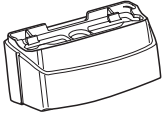

242 x4

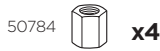

x4



x4



50273

x1

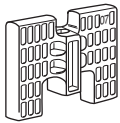

07 x4

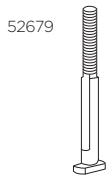

52679

x4

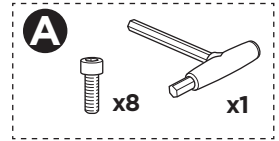

A

x8

x1

1

17

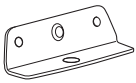

242

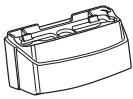

242

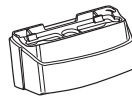

17

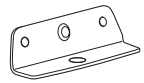

17

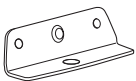

242

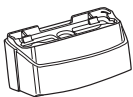

242



17

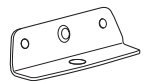

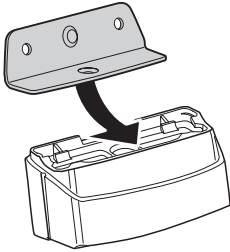
2**A****B**

- EN** Only a few turns
DE Nur wenige Umdrehungen
FR Quelques tours uniquement
NL Slechts enkele slagen
IT Solo qualche giro
ES Sólo algunas vueltas
PT Noções básicas
SV Endast några varv
DK Kun nogle få omgange
NE Bare noen få omdreinger
FI Vain muutama kierros
ET Ainult mõni pööre
LV Tikai dažī apgriezieni
LT Tik keli pasukimai
PL Wystarczy kilka obrotów
RU Только несколько оборотов

- UK** Лише декілька обертів
BG Само няколко завъртания
CS Pouze několik otáček
SK Len niekoľko otáčok
SL Le nekaj obratov
HR/BiH Samo nekoliko okreta
RO Doar câteva rotiri
HU Csak néhány fordítás
EL Μόνο λίγες περιστροφές
TR Yalnızca birkaç tur

بعض دورات فقط

AR

רק מספר סיבובים

HE

- ZH** 仅几圈
JA 2～3回転のみ
KO 몇 번만 돌리면 됨
TH เพียงสองสามรอบ

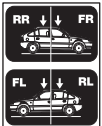
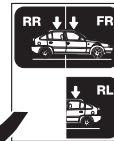
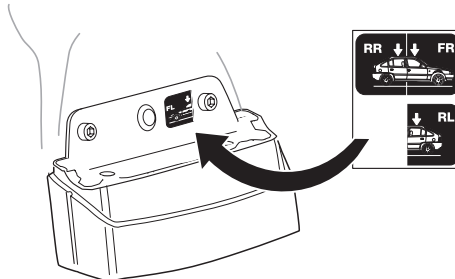
3**x1**

4

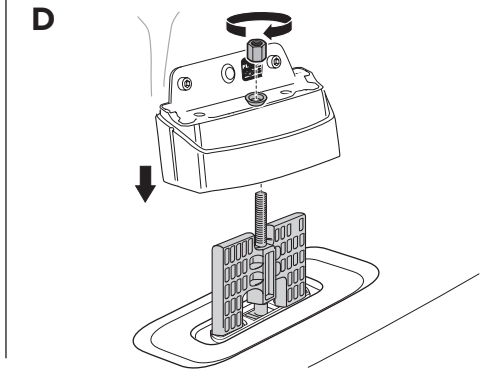
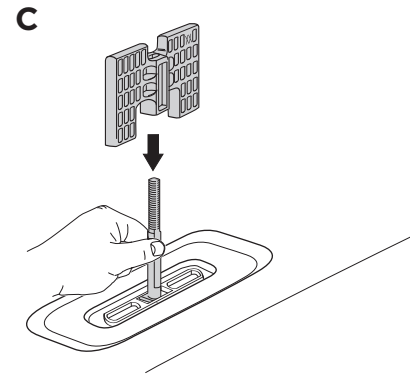
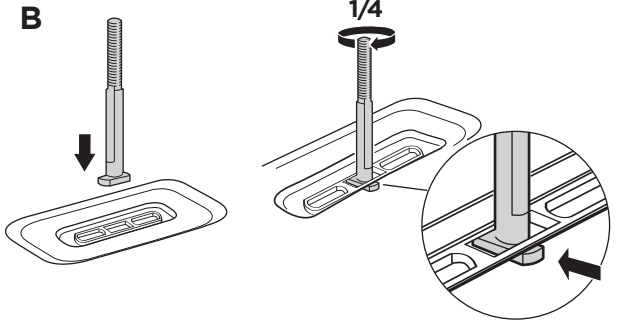
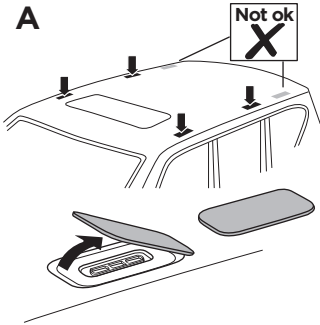
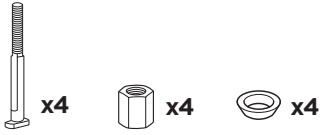

5

