

# Kit 1166

**CHEVROLET Cruze**, 3-dr Hatchback, 01-04

**CHEVROLET Cruze**, 5-dr Hatchback, 01-04

**SUZUKI Ignis**, 3-dr Hatchback, 00-04

**SUZUKI Ignis**, 5-dr Hatchback, 00-04

**SUZUKI Kei**, 3-dr Hatchback, 99-00

**SUZUKI Kei**, 5-dr Hatchback, 99-00

**SUZUKI Swift SE-Z**, 3-dr Hatchback, 99-04

**SUZUKI Swift SE-Z**, 5-dr Hatchback, 99-04

480R  
754

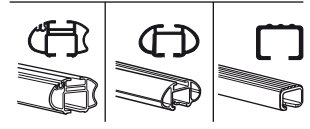
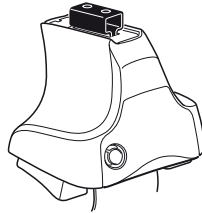

480

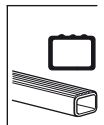
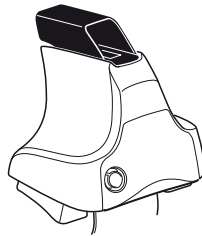

750

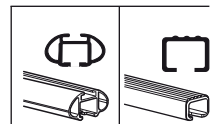
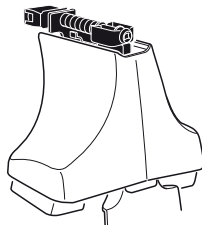

xx kg  
 xx lbs  
 + 7 kg / 15,4 lbs  
 = 3 kg / 6,6 lbs

**Max. 50kg**  
**Max. 110 lbs**

80 km/h 50 Mph  
 130 km/h 80 Mph  
 40 km/h 25 Mph  
**km/h Mph**

**THULE**

**Kit XXXX**  
 instructions

x1  
 x4  
 x4  
 x4

**480R/754**

x1  
 x4  
 x4  
 x4

**480**

x1  
 x4  
 x4

**750**

x2 x2 x2 x4	x2	x2 x2 x4 x4	x2 x2	x2

**318** x4

**15** x4

**x1**

**Kit**



3

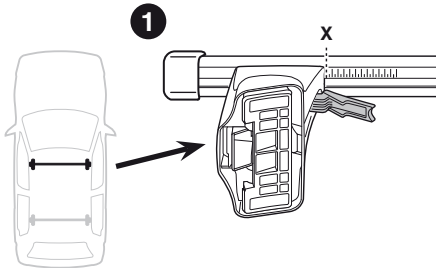
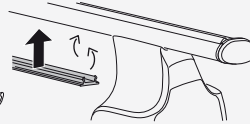
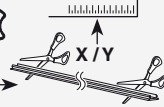

	X
<b>CHEVROLET Cruze</b> , 3-dr Hatchback, 01-04	34
<b>CHEVROLET Cruze</b> , 5-dr Hatchback, 01-04	34
<b>SUZUKI Ignis</b> , 3-dr Hatchback, 00-04	34
<b>SUZUKI Ignis</b> , 5-dr Hatchback, 00-04	34
<b>SUZUKI Kei</b> , 3-dr Hatchback, 99-00	21,5
<b>SUZUKI Kei</b> , 5-dr Hatchback, 99-00	21,5
<b>SUZUKI Swift SE-Z</b> , 3-dr Hatchback, 99-04	34
<b>SUZUKI Swift SE-Z</b> , 5-dr Hatchback, 99-04	34

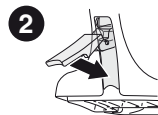
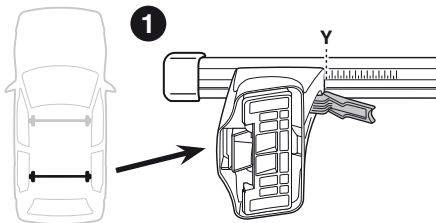

	Y
<b>CHEVROLET Cruze</b> , 3-dr Hatchback, 01-04	31,5
<b>CHEVROLET Cruze</b> , 5-dr Hatchback, 01-04	31,5
<b>SUZUKI Ignis</b> , 3-dr Hatchback, 00-04	31,5
<b>SUZUKI Ignis</b> , 5-dr Hatchback, 00-04	31,5
<b>SUZUKI Kei</b> , 3-dr Hatchback, 99-00	19
<b>SUZUKI Kei</b> , 5-dr Hatchback, 99-00	19
<b>SUZUKI Swift SE-Z</b> , 3-dr Hatchback, 99-04	31,5
<b>SUZUKI Swift SE-Z</b> , 5-dr Hatchback, 99-04	31,5

**3**



480R



480

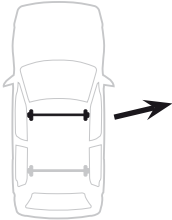
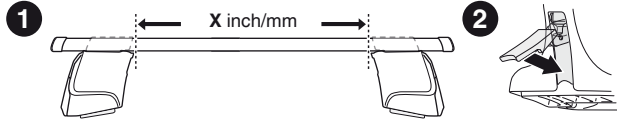

	X inch	X mm
<b>CHEVROLET Cruze</b> , 3-dr Hatchback, 01-04	39"	991 mm
<b>CHEVROLET Cruze</b> , 5-dr Hatchback, 01-04	39"	991 mm
<b>SUZUKI Ignis</b> , 3-dr Hatchback, 00-04	39"	991 mm
<b>SUZUKI Ignis</b> , 5-dr Hatchback, 00-04	39"	991 mm
<b>SUZUKI Kei</b> , 3-dr Hatchback, 99-00	34 1/8"	866 mm
<b>SUZUKI Kei</b> , 5-dr Hatchback, 99-00	34 1/8"	866 mm
<b>SUZUKI Swift SE-Z</b> , 3-dr Hatchback, 99-04	39"	991 mm
<b>SUZUKI Swift SE-Z</b> , 5-dr Hatchback, 99-04	39"	991 mm

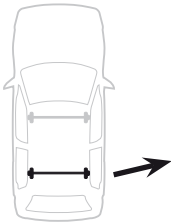
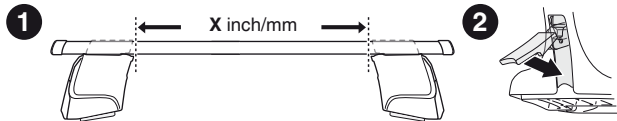

	Y inch	Y mm
<b>CHEVROLET Cruze</b> , 3-dr Hatchback, 01-04	38"	966 mm
<b>CHEVROLET Cruze</b> , 5-dr Hatchback, 01-04	38"	966 mm
<b>SUZUKI Ignis</b> , 3-dr Hatchback, 00-04	38"	966 mm
<b>SUZUKI Ignis</b> , 5-dr Hatchback, 00-04	38"	966 mm
<b>SUZUKI Kei</b> , 3-dr Hatchback, 99-00	33 1/8"	841 mm
<b>SUZUKI Kei</b> , 5-dr Hatchback, 99-00	33 1/8"	841 mm
<b>SUZUKI Swift SE-Z</b> , 3-dr Hatchback, 99-04	38"	966 mm
<b>SUZUKI Swift SE-Z</b> , 5-dr Hatchback, 99-04	38"	966 mm

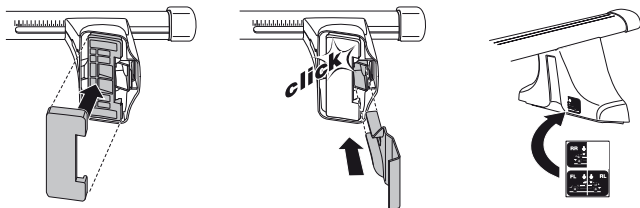
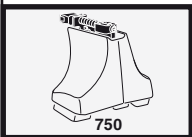
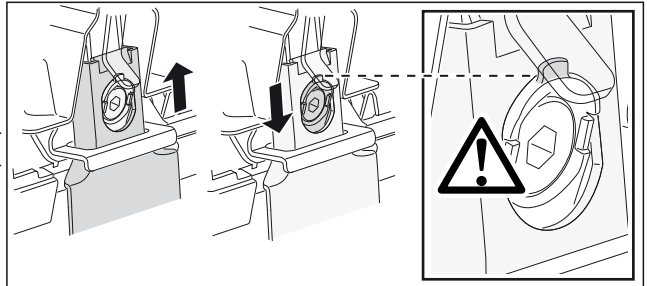
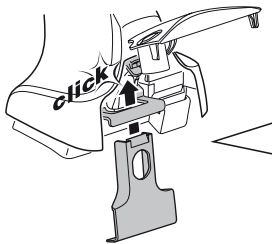
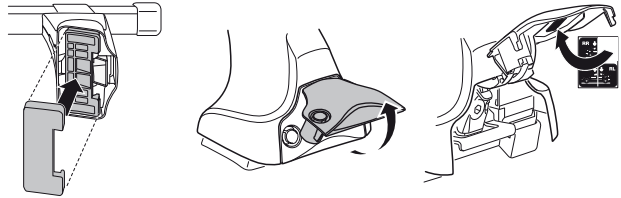
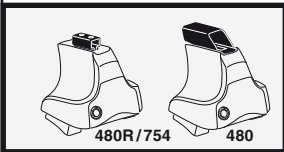
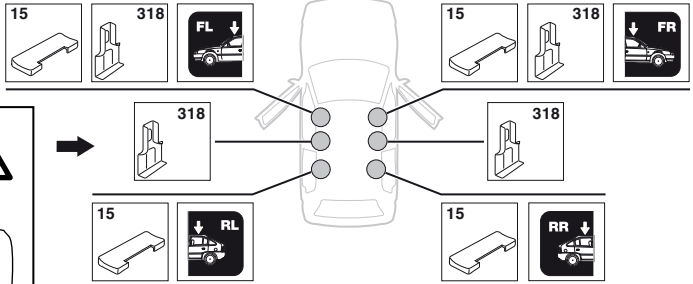
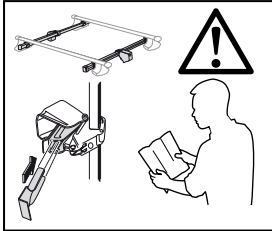
**4****CHEVROLET Cruze**, 3-dr Hatchback, 01-04**SUZUKI Ignis**, 3-dr Hatchback, 00-04**SUZUKI Kei**, 3-dr Hatchback, 99-00**SUZUKI Swift SE-Z**, 3-dr Hatchback, 99-04**SRA**

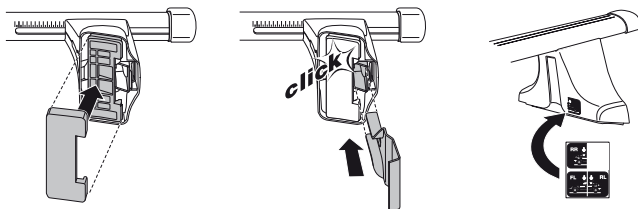
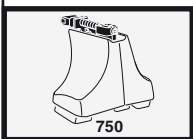
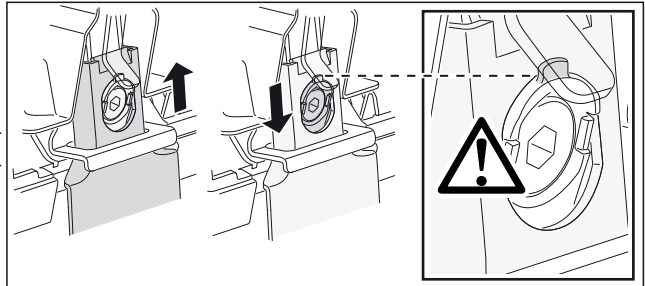
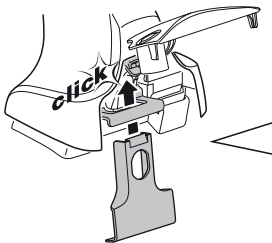
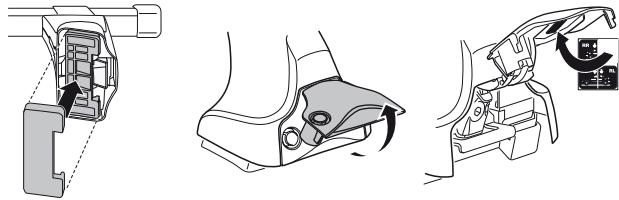
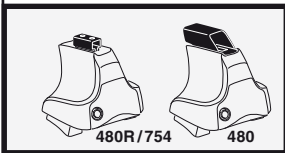
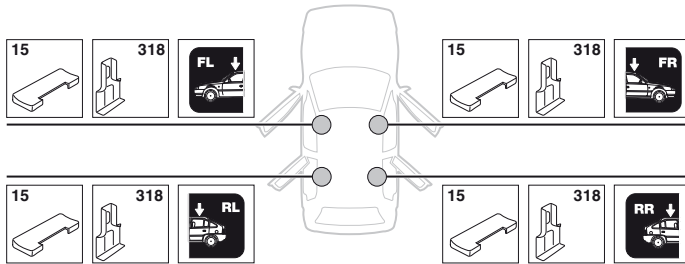
**4****CHEVROLET Cruze**, 5-dr Hatchback, 01-04**SUZUKI Ignis**, 5-dr Hatchback, 00-04**SUZUKI Kei**, 5-dr Hatchback, 99-00**SUZUKI Swift SE-Z**, 5-dr Hatchback, 99-04

5

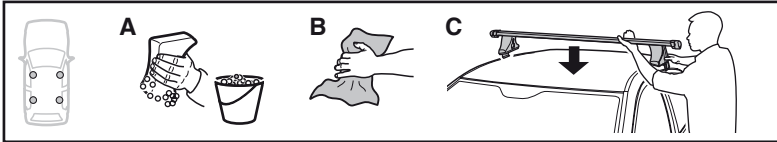

	X mm	Y mm	Z mm	X inch	Y inch	X inch
<b>CHEVROLET Cruze</b> , 3-dr Hatchback, 01-04	210 mm	700 mm	360 mm	8 1/4"	27 1/2"	14 1/8"
<b>SUZUKI Ignis</b> , 3-dr Hatchback, 00-04	210 mm	700 mm	360 mm	8 1/4"	27 1/2"	14 1/8"
<b>SUZUKI Kei</b> , 3-dr Hatchback, 99-00	210 mm	700 mm	360 mm	8 1/4"	27 1/2"	14 1/8"
<b>DSUZUKI Swift SE-Z</b> , 3-dr Hatchback, 99-04	210 mm	700 mm	360 mm	8 1/4"	27 1/2"	14 1/8"

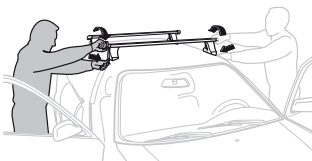
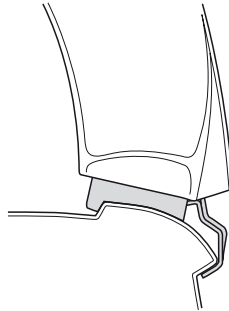
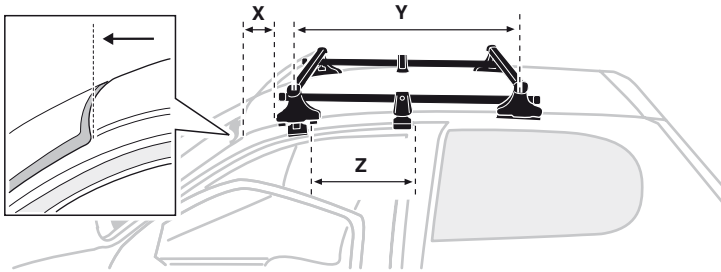

**GB/US** Tighten alternately

**D** Die Schrauben abwechselnd anziehen

**F** Serrer alternativement chaque côté

**NL** Afwisselend aan de linker- en de rechterkant aandraaien

**I** Alternare il serraggio delle viti

**E** Apretar alternativamente

**PT** Aperte alternadamente

**S** Dra åt växelvis

**FIN** Kierrä vuorotellen

**EST** Pinguldage vaheldumisi

**LAT** Pielveiciet pamišus

**LIT** Užsukinėkite pakaitomis

**PL** Śruby dokręcaj naprzemiennie

**RU** Затягивайте попеременно

**CZ** Pokręťta багаžníka dokręcaj dokręcaj naprzemiennie.

**SK** Dotahujte striedavo

**SLO** Privijajte izmenično.

**HR** Naizmjenično zategnite

**HU** Egymástól függetlenül szorítandó

**GR** Σφιγγετε εναλλάξ

**TR** Dönüşümlü sıkın

**中文** 交替拧紧

**한국어** 번갈아 가며 조이십시오.

**日本語** 交互に締め付けてください。

**ไทย** ขันในแบบสลับ



5

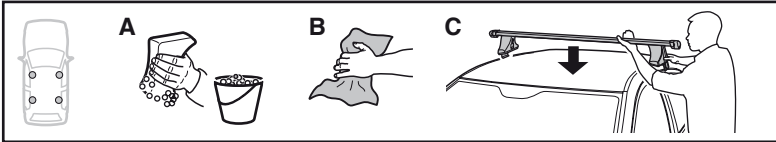

	X mm	Y mm	X inch	Y inch
<b>CHEVROLET Cruze</b> , 5-dr Hatchback, 01-04	210 mm	700 mm	8 1/4"	27 1/2"
<b>SUZUKI Ignis</b> , 5-dr Hatchback, 00-04	210 mm	700 mm	8 1/4"	27 1/2"
<b>SUZUKI Kei</b> , 5-dr Hatchback, 99-00	210 mm	700 mm	8 1/4"	27 1/2"
<b>SUZUKI Swift SE-Z</b> , 5-dr Hatchback, 99-04	210 mm	700 mm	8 1/4"	27 1/2"

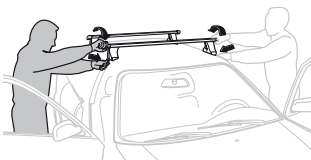
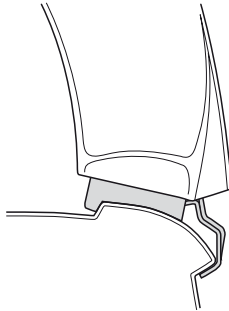
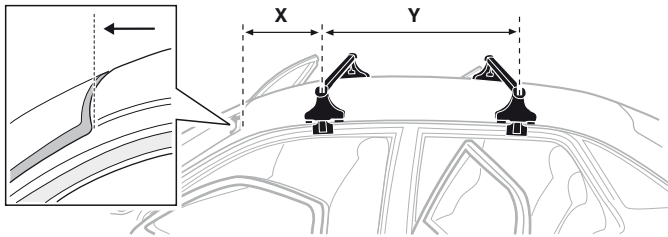

- |              |   |            |   |
|--------------|---|------------|---|
| <b>GB/US</b> | Tighten alternately                                     | <b>CZ</b>  | Pokreťta bagažnika dokrečej dokrečej naprzemiennie. |
| <b>D</b>     | Die Schrauben abwechselnd anziehen                      | <b>SK</b>  | Dotahujte striedavo                                 |
| <b>F</b>     | Serrer alternativement chaque côté                      | <b>SLO</b> | Privijajte izmenično.                               |
| <b>NL</b>    | Afwisselend aan de linker- en de rechterkant aandraaien | <b>HR</b>  | Naizmjenično zategnite                              |
| <b>I</b>     | Alternare il serraggio delle viti                       | <b>HU</b>  | Egymástól függetlenül szorítandó                    |
| <b>E</b>     | Apretar alternativamente                                | <b>GR</b>  | Σφιγίγετε εναλλάξ                                   |
| <b>PT</b>    | Aperte alternadamente                                   | <b>TR</b>  | Dönüşümlü sıkın                                     |
| <b>S</b>     | Dra åt växelvis   | <b>中文</b>  | 交替拧紧  |
| <b>FIN</b>   | Kierrä vuorotellen                                      | <b>한국어</b> | 변갈아 가며 조이십시오.                                       |
| <b>EST</b>   | Pinguldage vaheldumisi                                  | <b>日本語</b> | 交互に締め付けてください。                                       |
| <b>LAT</b>   | Pielieciet pamišus                                      | <b>ไทย</b> | ขันในแบบสลับ  |
| <b>LIT</b>   | Užsukinėkite pakaitomis                                 |            |   |
| <b>PL</b>    | Śruby dokrećaj naprzemiennie                            |            |   |
| <b>RU</b>    | Затягивайте попеременно                                 |            |   |

6



480R/754



480

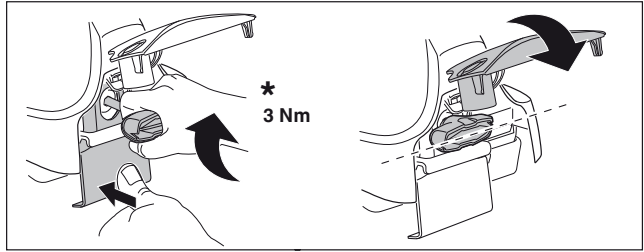
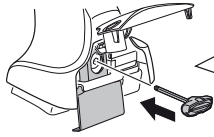

\*  
3 Nm

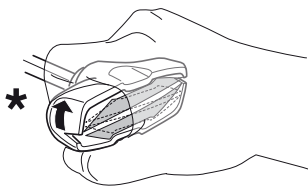

\*

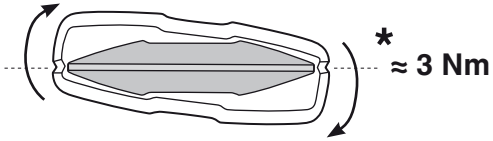

\*  
≈ 3 Nm

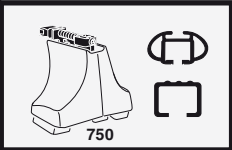
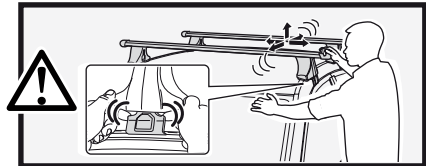

750

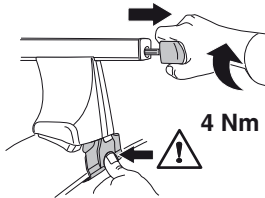

4 Nm

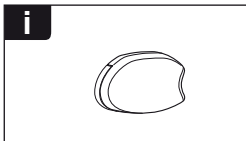
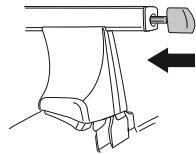

i

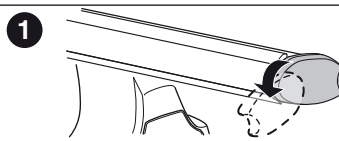

1

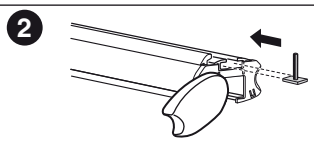

2

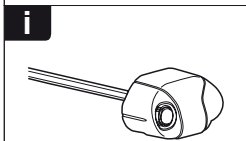

i

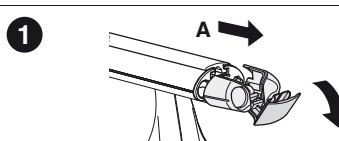

1

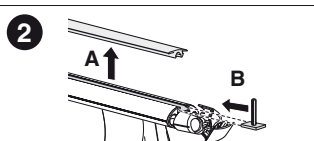

2

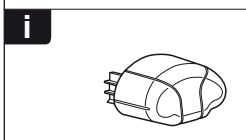

i

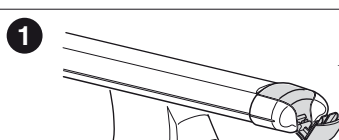

1

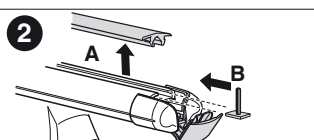

2



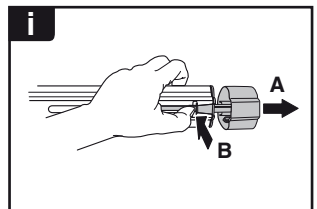
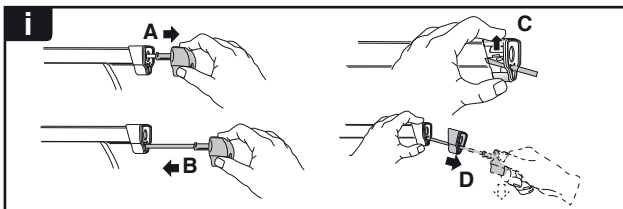
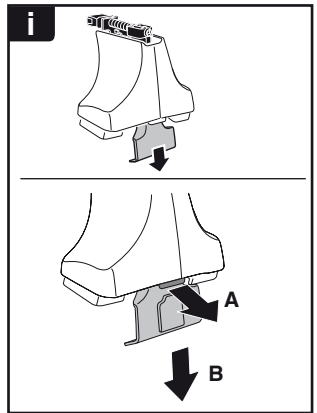
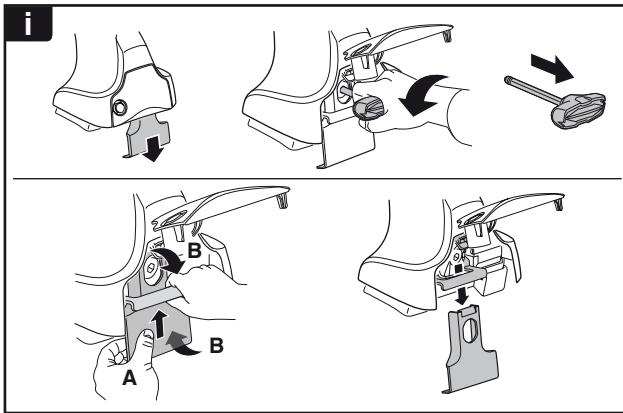
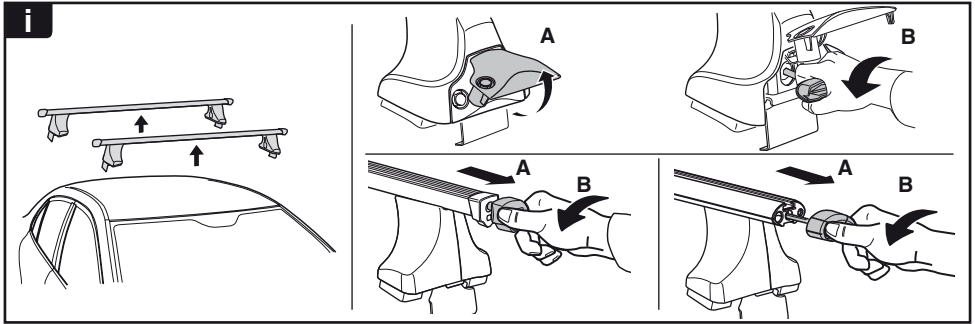

**THULE**  
SWEDEN  
**ONE  
KEY  
SYSTEM**

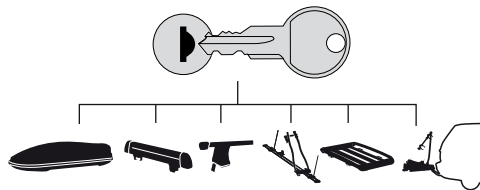

- 544 (x4)
- 596 (x6)
- 588 (x8)
- NA 510 (x10)
- EUR 452 (x12)
- ASIA

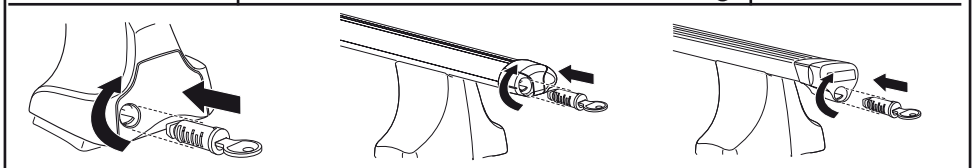

WW ▶ Thule Sweden AB, Box 69, 330 33 Hillerstorp, SWEDEN  
NA ▶ Thule Inc., 42 Silvermine Road, Seymour, Connecticut 06483, USA

info@thule.com  
customer.service@thule.com

www.thule.com