

- | | | | |
|-------|-----------------------------|-------|-----------------------------------|
| (D) | Einbauanleitung | (PL) | Instrukcja montażu |
| (GB) | Installation instructions | (TR) | Montaj talimatı |
| (F) | Consignes de montage | (H) | Beépítési útmutató |
| (NL) | Montagehandleiding | (HR) | Upute o ugradnji |
| (DK) | Montagevejledning | (BUL) | Инструкция за монтаж |
| (N) | Monteringsinstruksjon | (RO) | Instrucțiuni de montaj |
| (S) | Installationsanvisning | (RU) | Инструкция по монтажу и установке |
| (FIN) | Asennusohje | (LT) | Montavimo informacija |
| (I) | Istruzioni per il montaggio | (LV) | Iemontēšanas pamācība |
| (E) | Instrucciones de montaje | (EST) | Paigaldusjuhend |
| (P) | Instruções de montagem | (SLO) | Navodilo za vgradnjo |
| (GR) | Οδηγίες εγκατάστασης | (SK) | Montážny návod |
| (CZ) | Návod k montáži | | |

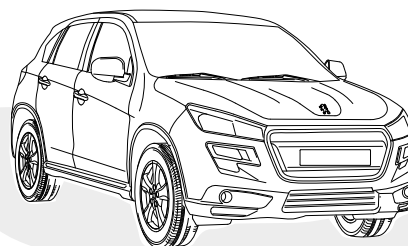

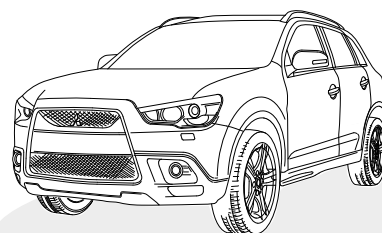

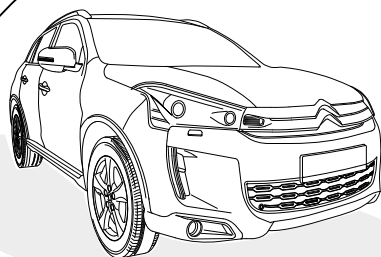





CITROËN C4 Aircross
MITSUBISHI ASX
PEUGEOT 4008









06/12 >>









06/10 >>

06/12 >>

Follow me...

	<p>Hinweis:</p> <p>Vor Beginn der Montage sind folgende Hinweise zu beachten:</p> <p>Die Einbauanleitung ist vollständig durchzulesen. Der Einbau sollte nur von Fachpersonal mit entsprechenden Fachkenntnissen durchgeführt werden. Es müssen aktuelle Hinweise und Informationen der Fahrzeughersteller zu Um- und Nachrüstungen beachtet werden. Die Aus- und Einbauschritte müssen anhand der aktuellen Reparaturleitfäden durchgeführt werden. Es muss sichergestellt sein, dass das Fahrzeug technisch für den Betrieb einer Anhängerkupplung geeignet ist.</p>
	<p>Reference:</p> <p>The following information must be reviewed before beginning the assembly:</p> <p>The installation instructions are to be thoroughly read. The installation should be carried out by qualified personnel with the relevant technical knowledge. The vehicle manufacturers' current technical notices and information on retrofitting must be followed. The removal and replacement instructions found in the current repair manuals must be followed. It must be ensured that the vehicle is technically suitable for the installation of a trailer hitch.</p>
	<p>Remarque :</p> <p>Avant de procéder au montage, respecter les instructions suivantes :</p> <p>Lire impérativement l'instruction d'installation intégralement. L'installation doit être réalisée exclusivement par un personnel spécialisé disposant des connaissances professionnelles adéquates. Les instructions et les informations actuelles du constructeur automobile pour la transformation et le rééquipement doivent être respectées. Les phases de démontage et de montage doivent être réalisées au moyen des guides de réparation en vigueur actuellement. Il faut s'assurer que le véhicule est techniquement approprié à l'usage d'un dispositif d'attelage de remorque.</p>
	<p>Opmerking:</p> <p>Vóór begin van de montage moeten de volgende aanwijzingen in acht genomen worden:</p> <p>De inbouwaanwijzing moet helemaal doorgelezen worden. De inbouw mag alleen van vakpersoneel met desbetreffende vakkennissen uitgevoerd worden. Er moeten de actuele aanwijzingen en informatie van de voertuigproducent over ombouwingen en toerusting in acht genomen worden. De uit- en inbouwstappen moeten aan de hand van de actuele reparatieleidraad uitgevoerd worden. Er moet verzekerd zijn, dat het voertuig technisch voor het bedrijf van een aanhangwagenkoppeling geschikt is.</p>
	<p>Henvisning:</p> <p>Bemærk følgende anvisninger, inden du påbegynder monteringsarbejdet:</p> <p>Læs hele monteringsvejledningen igennem. Montering må kun foretages af faguddannet personale, der besidder den nødvendige kvalifikation. Aktuelle anvisninger og informationer fra køretøjets producent angående ombygning og eftermontering skal iagttages. De enkelte arbejdsskridt ved af- og påmontering skal udføres ifølge den aktuelle reparationshåndbog. Forvis dig om, at køretøjet er teknisk egnet til brug af anhængerkobling.</p>
	<p>Henvisning:</p> <p>Før man begynner monteringen må man ta hensyn til følgende merknader:</p> <p>Man må lese gjennom hele monteringsveiledningen. Monteringen må kun gjennomføres av fagpersonell med respektive fagkunnskaper. Man må ta følge de aktuelle merknadene og informasjonene fra kjøretøyproduzenten angående ombygging og modifisering. Monterings- og demonteringsstrinnene må gjennomføres i henhold til den aktuelle retningslinjen for reparasjoner. Man må forsikre seg om at kjøretøyet er teknisk egnet for drift med tilhengerkoppeling.</p>
	<p>Anm:</p> <p>Innan montering sker ska följande anvisningar beaktas:</p> <p>Den fullständiga monteringsanvisningen ska läsas igenom. Montering får bara utföras av fackpersonal med motsvarande fackkunnskaper. Aktuella anvisningar och information från fordonstillverkarna gällande modifieringar och kompletteringar ska beaktas. Demonterings- och monteringsstegen ska utföras med ledning av de aktuella reparationsanvisningarna. Det ska säkerställas att fordonet är tekniskt lämpat för drift med dragkrok.</p>
	<p>Huomautus:</p> <p>Ennen asennusta on huomioitava seuraavat ohjeet:</p> <p>Asennusohje on luettava täydellisesti. Asennuksen saa suorittaa vain vastaavan pätevyyden omaava henkilöstö. Ota huomioon ajoneuvon valmistajan antamat muuttamista ja jälkivarustamista koskevat ohjeet ja tiedotteet. Purkamis- ja asennusvaiheet tulee suorittaa ajankohtaisia korjausohjeita noudattaen. Täytyy varmistaa, että ajoneuvo on teknisesti soveltuva perävaunun hinauskytkimen käyttöön.</p>

	<p>Avvertenza:</p> <p>Prima di procedere con il montaggio, osservare le seguenti indicazioni:</p> <p>Leggere le istruzioni di montaggio in ogni parte. Il montaggio deve essere effettuato solo da personale specializzato con conoscenze specifiche. Devono essere osservate le indicazioni e informazioni aggiornate del produttore del veicolo relativamente agli interventi di trasformazione e potenziamento. Gli interventi di montaggio e smontaggio devono essere eseguiti nel rispetto delle linee guida aggiornate relativamente alla riparazione. Si raccomanda di verificare che il veicolo sia tecnicamente idoneo per gestire un gancio di traino.</p>
	<p>Advertencia:</p> <p>Antes de iniciar el montaje se deben observar las siguientes indicaciones:</p> <p>Se deben leer completamente las instrucciones de montaje. El montaje sólo se debe realizar por personal especializado con los correspondientes conocimientos en la materia. Se deben respetar todas las observaciones e informaciones del fabricante del vehículo sobre reequipamientos. Los pasos de desmontaje y montaje se tienen que ejecutar según las directrices actuales de reparación. Se debe garantizar que el vehículo sea adecuado técnicamente para el servicio de un enganche para remolque.</p>
	<p>Aviso:</p> <p>Antes do início da montagem deve-se observar os seguintes avisos.</p> <p>As instruções de montagem devem ser lidas por completo. A montagem só deve ser realizada por pessoal especializado com os respectivos conhecimentos específicos. Deve-se observar os avisos e informações atuais para ajustes e adaptações do produtor do veículo. Os passos da montagem e de prolongamento têm que ser realizados de acordo com as atuais diretivas de reparos. Deve-se garantir que o veículo é tecnicamente apropriado para o funcionamento com um acoplamento de reboque.</p>
	<p>Υπόδειξη:</p> <p>Πριν αρχίσετε τη συναρμολόγηση προσέξτε τις ακόλουθες υποδείξεις:</p> <p>Διαβάστε όλες τις οδηγίες εγκατάστασης. Η εγκατάσταση πρέπει να γίνει μόνο από ειδικό προσωπικό με τις ανάλογες τεχνικές γνώσεις. Προσέξτε τις τελευταίες υποδείξεις και πληροφορίες των εργοστασίων των οχημάτων σχετικά με τις διαρρυθμίσεις και μεταρρυθμίσεις του εξοπλισμού. Τα βήματα εγκατάστασης και απεγκατάστασης πρέπει να εκτελεστούν σύμφωνα με τις τελευταίες οδηγίες επισκευής. Πρέπει να είστε βέβαιοι ότι το όχημα είναι κατάλληλο από τεχνικής πλευράς για την τοποθέτηση και λειτουργία κοτσαδόρου.</p>
	<p>Pokyn:</p> <p>Před zahájením montáže je nutno dodržovat následující pokyny:</p> <p>Návod k montáži je nutno kompletně pročíst. Montáž by měl provádět pouze odborný personál s odpovídajícími odbornými znalostmi. Musíte dodržovat aktuální pokyny a informace výrobce k přestavbám a dodatečnému vybavení. Demontážní a montážní kroky musíte provádět podle aktuálních návodů k opravám. Musíte zajistit, aby bylo vozidlo technicky způsobilé pro provoz závěsného zařízení přívěsu.</p>
	<p>Wskazówka:</p> <p>Należy przeczytać dokładnie i w całości instrukcję montażu.</p> <p>Montaż powinien zostać przeprowadzony przez wyspecjalizowany personel z odpowiednią wiedzą specjalistyczną. Należy zwrócić uwagę na aktualne informacje producenta pojazdu dotyczące przebudowy i wyposażenia dodatkowego. Demontaż i montaż należy przeprowadzać zgodnie z aktualnymi informacjami dotyczącymi naprawy. Należy upewnić się, czy pojazd znajduje się w stanie technicznym, który umożliwia założenie sprzęgu przyczepowego.</p>
	<p>Bilgi:</p> <p>Montajdan önce aşağıdaki uyarılara dikkat edilmelidir:</p> <p>Montaj talimatının tamamıyla okunması gerekmektedir. Montaj sadece ilgili uzman bilgilerine sahip uzman personel tarafından yapılmalıdır. Araç üreticisinin yeniden donatma ve sonradan donatmayla ilgili aktüel uyarılara dikkat edilmesi gerekmektedir. Sökme ve monte etme adımlarının güncel tamir kılavuzlarına göre yapılması gerekmektedir. Aracın teknik olarak çekme kancasının işletilmesi için uygun olmasının sağlanması gerekmektedir.</p>
	<p>Utalás:</p> <p>A szerelés megkezdése előtt a következő útmutatásokat kell figyelembe venni:</p> <p>Teljesen el kell olvasni a beszerelési útmutatót. A beszerelést csak megfelelő szakismeretekkel rendelkező szakembernek szabad végeznie. Figyelembe kell venni a járműgyártó át- és utólagos beszerelésre vonatkozó aktuális útmutatásait és információit. A ki- és beszerelési lépéseket az aktuális javítási kézikönyvek alapján kell végrehajtani. - Biztosítani kell, hogy a jármű műszaki szempontból alkalmas legyen vonóhorog használatára.</p>
	<p>Uputa:</p> <p>Prije početka montaže valja uzeti u obzir sljedeće naputke:</p> <p>U cijelosti je potrebno pročitati upute za ugradnju. Ugradnju bi trebalo provoditi samo stručno osoblje s odgovarajućim poznavanjem struke. Ono se mora pridržavati aktualnih naputaka i informacija proizvođača vozila o preinaci i dodatnom opremanju. Koraci vađenja i ugradnje moraju se provesti na osnovi aktualnih smjernica za popravljanje. Mora se osigurati da vozilo tehnički bude prikladno za rad spojke prikolice.</p>

	<p>Указание:</p> <p>Преди начало на монтажа е необходимо да се съблюдават следните указания:</p> <p>Упътването за монтаж трябва да се прочете изцяло. Монтажът трябва да се извърши само от специализиран персонал със съответните специализирани познания. Трябва да се съблюдават актуалните указания и информация на производителя на превозното средство за преоборудвания и следоборудвания. Стъпките по разглобяване и сглобяване следва да се извършват с помощта на актуалните ръководства за ремонт. Трябва да е установено, че превозното средство е технически подходящо за експлоатация на теглич за ремарке.</p>
	<p>Indicație:</p> <p>Înainte de a începe montajul se vor avea în vedere următoarele:</p> <p>Instrucțiunile de montaj trebuie citite integral. Se recomandă ca montajul să fie executat numai de către personal calificat cu cunoștințe de specialitate. Instrucțiunile și recomandările actuale ale producătorului autovehiculului privitoare la modificări și completări ale dotării trebuie respectate. Operațiunile de demontare respectiv montare trebuie efectuate în conformitate cu îndreptările de reparații actuale. Trebuie clarificat dacă vehiculul este adecvat pentru utilizarea unui cuplaj de remorcare.</p>
	<p>Указание:</p> <p>Перед началом установки необходимо учесть следующие указания:</p> <p>Полностью прочитайте руководство по установке. Установка должна проводиться только специально обученным персоналом, имеющим соответствующие знания. Необходимо учитывать актуальные указания и информацию по переоснащению и дооборудованию завода-изготовителя транспортного средства. Все действия по демонтажу и монтажу необходимо проводить руководствуясь указаниями по ремонту. Необходимо убедиться в том, что транспортное средство технически подходит для установки тягово-сцепного устройства.</p>
	<p>Nuoroda:</p> <p>Pirms montāžas sākuma jāievēro sekojoši noteikumi:</p> <p>Pilnībā jāizlasa montāžas instrukcija. Montāžu drīkst veikt tikai šim nolūkam apmācīts speciālists. Jāievēro aktuālos transportlīdzekļa ražotāja norādījumus un informāciju par pārbūvi un aprikošanu. Demontāžas un montāžas pasākumi jāveic saskaņā ar aktuālajiem norādījumiem par remontēšanu. Jāpārliecinās, ka transportlīdzeklis ir tehniski piemērots lietošanai ar piekabes sajuģu.</p>
	<p>Norādījums:</p> <p>Priekš pradēdant ģmontavimā ģturi bģti laikomasi ţiģ nurodymģ:</p> <p>Turi bģti perskaityta visa ģmontavimo instrukcija. ģmontavimas turi bģti atliktas tik kvalifikuoto personalo su atitinkamomis kvalifikacinģmis ţiniomis. Turi bģti laikomasi aktualiģ transporto priemonģs gamintoģģ nurodymģ bei informacijos, skirtģ pertvarkymui ir derinimui. Ĭsmontavimo ir ģmontavimo darbai turi bģti atliekami pagal aktualģ remonto vadovā. Nustatyti, kad transporto priemonģ techniniu atţvilgiu tinkama eksploatuoti su sukabinamuoju ģtaisv.</p>
	<p>Juhis:</p> <p>Enne montaaži alustamist tuleb jārgida jārgmisi juhiseid:</p> <p>Lugeda tāielikult lābi paigaldusjuhend. Paigaldamise peaks teostama ţuksnes vastavate erialaste oskustega personal. Tuleb jārgida sōiduki tootja ajakohaseid juhiseid ja ajakohast infot ţmberehituste ja tagantjārele muudatuste tegemise kohta. Lahti- ja kokkupaneke tuleb teostada ajakohaste remondijuhiste kohaselt. Tuleb veenduda, et sōiduk sobib tehniliselt haakeseadmega tōotamiseks.</p>
	<p>Navodilo:</p> <p>Pred začetkom montaţe morate upoţtevatģ naslednja navodila:</p> <p>natanĉno preberite navodila za uporabo; montaţo lahko izvaja samo strokovno osebje z ustreznim strokovnim znanjem; pred predelavami vozila in dodajanjem opreme morate upoţtevatģ aktualna navodila in informacije proizvajalca vozila; Korake postopka demontaţe in montaţe morate izvesti s pomoĉjo aktualnih navodil za popravila. Zagotoviti morate, da je vozilo tehniĉno primerno za priklop prikljuĉka za prikolico;</p>
	<p>Pokyn:</p> <p>Pred zaĉiatkom montaţe treba dodrţať nasledujģce upozornenia:</p> <p>Preĉitajte si celģ montāţny nāvod. Montāţ by mal vykonať iba odbornģ personāl so zodpovedajģcimi odbornģmi znalosťami. Treba dodrţiavať aktuálne upozornenia a informácie vģrobcu vozidla tģkajģce sa prestavby a dodatōĉného vybavenia. Jednotlivģ kroky pri demontāţi a montāţi musia byť vykonanģ na zāklade aktuálnych nāvodov na opravy. Musģ byť zaistenģ, ţe vozidlo je technicky vhodnģ na prevādzku s ţaţnģm zariadenģm.</p>

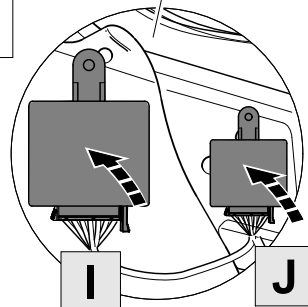
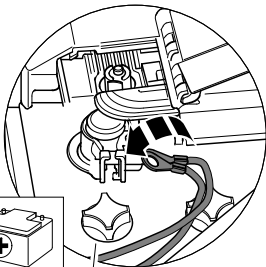
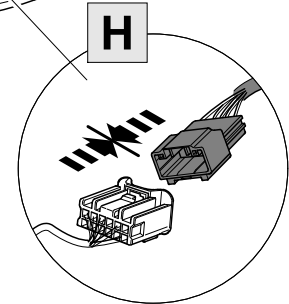
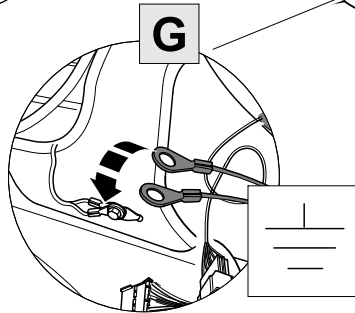
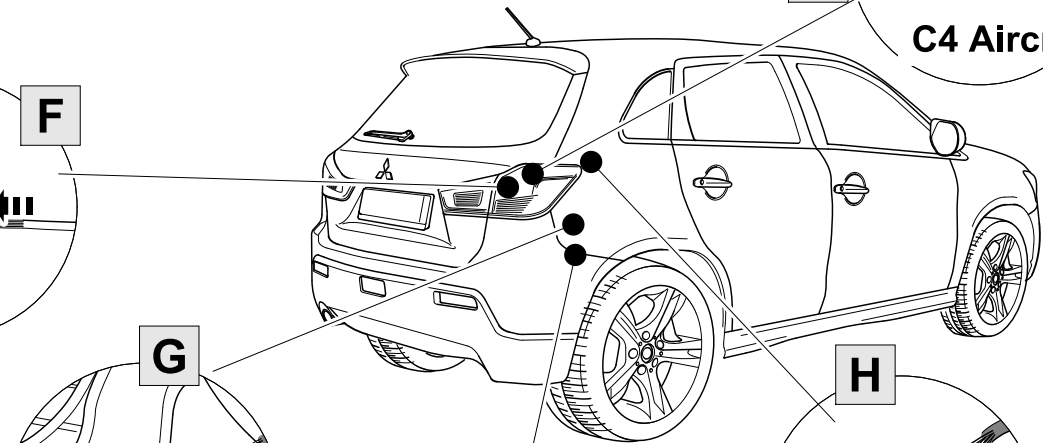
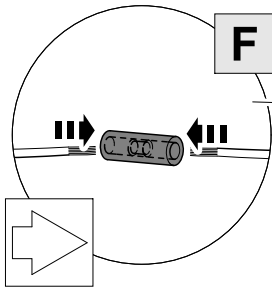
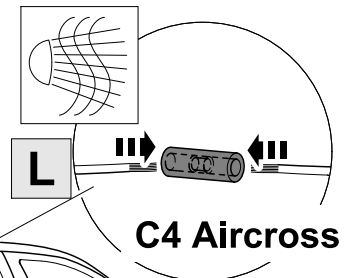
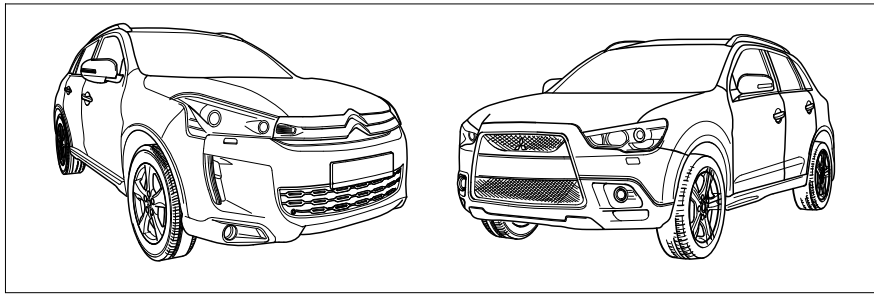

Mitsubishi ASX
Peugeot 4008

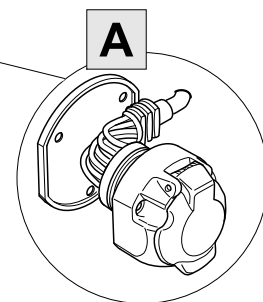
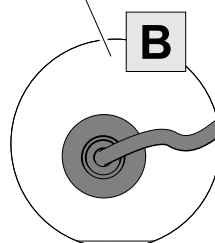
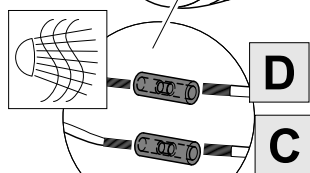
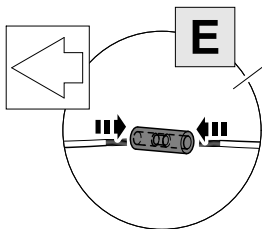
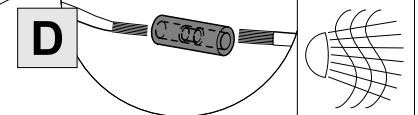
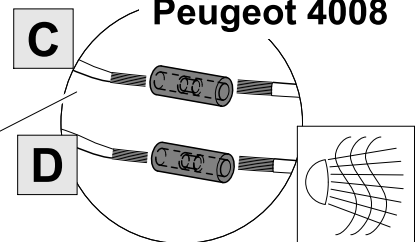
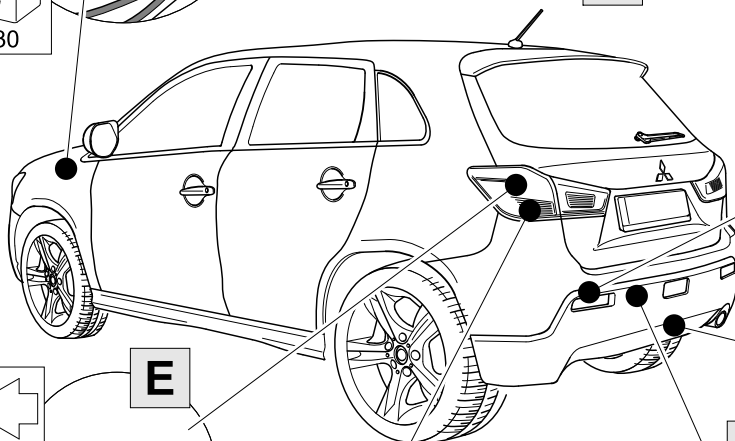
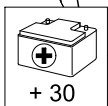

C4 Aircross

KIT 7 PIN

729493

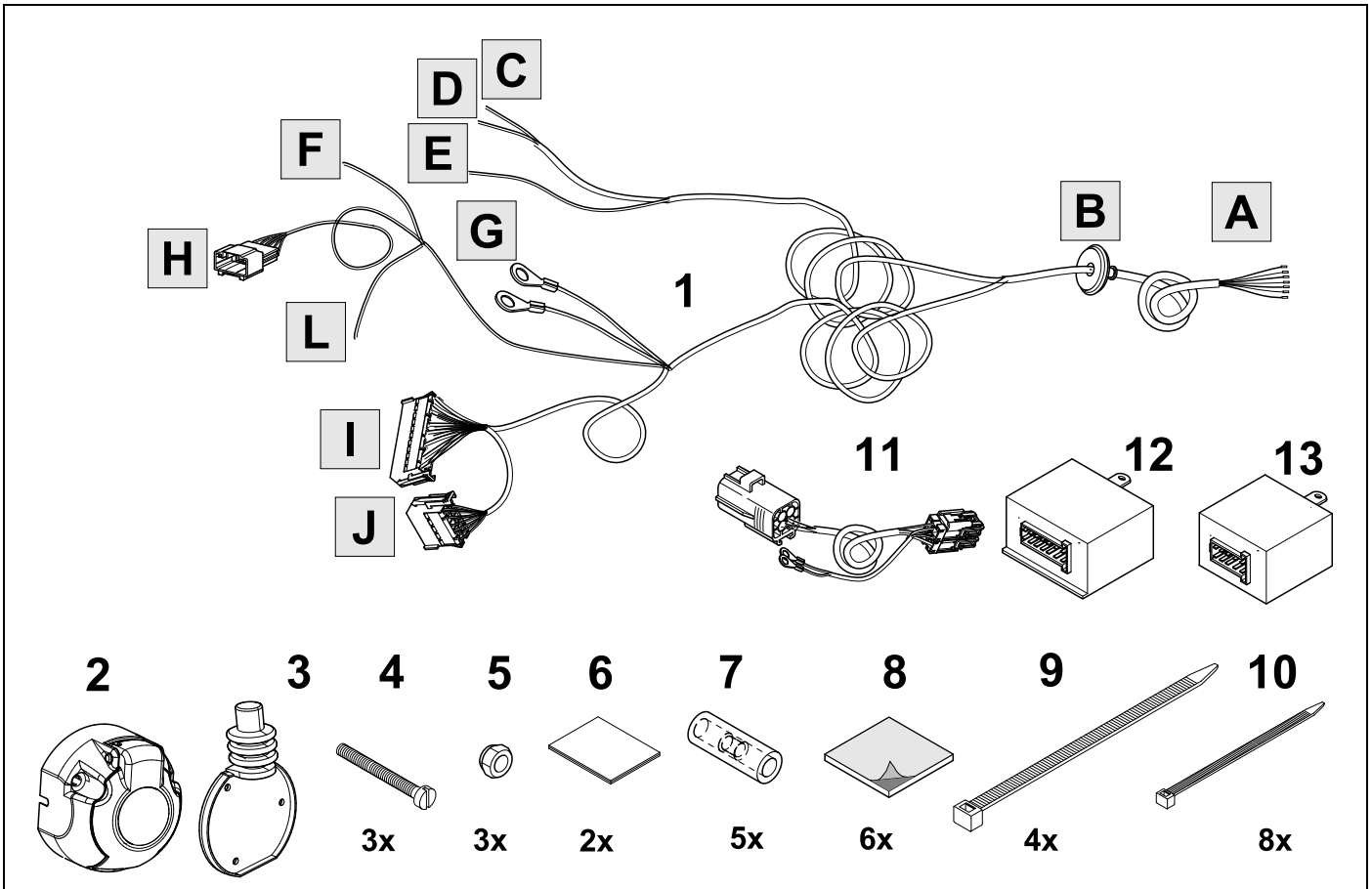

KIT 13 PIN

729494

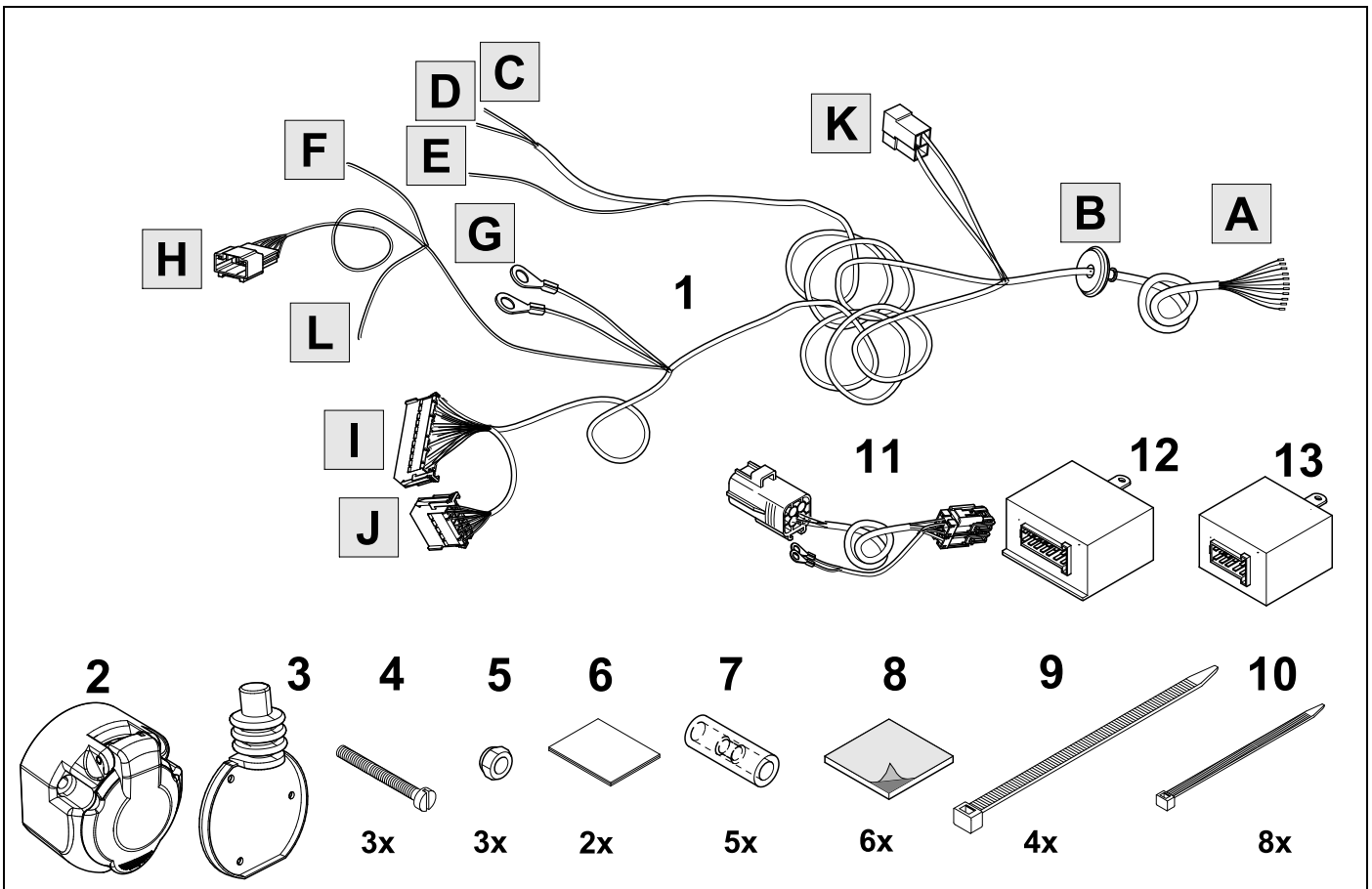

TOOLS

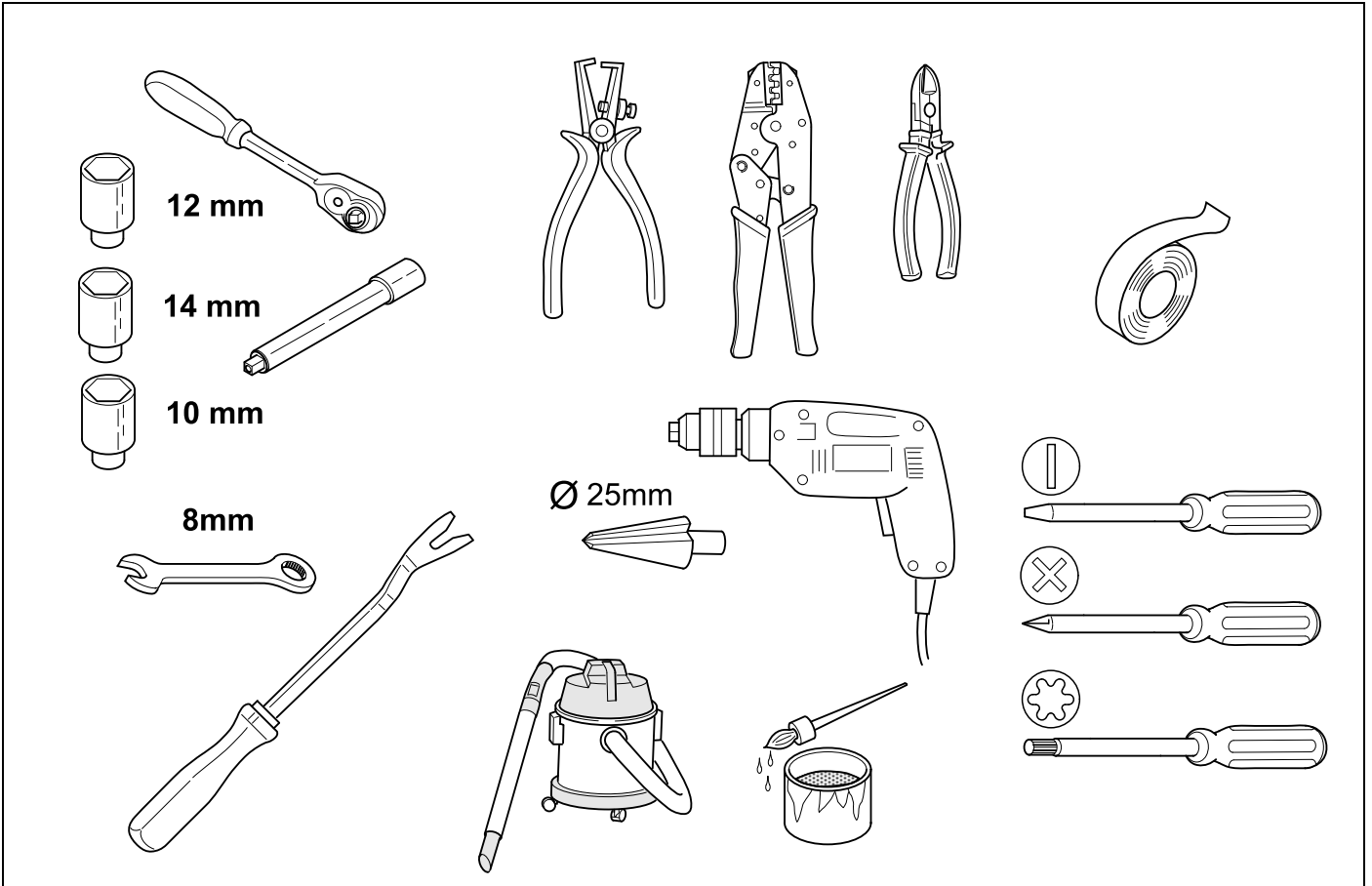

1

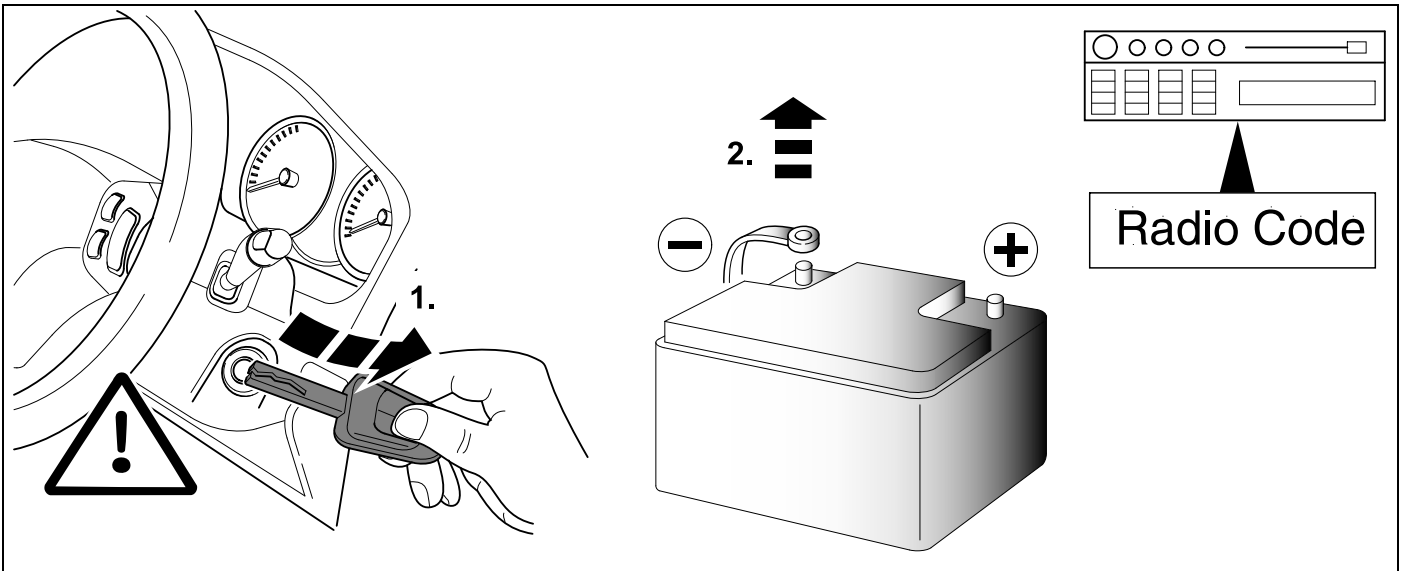

2

REMOVE

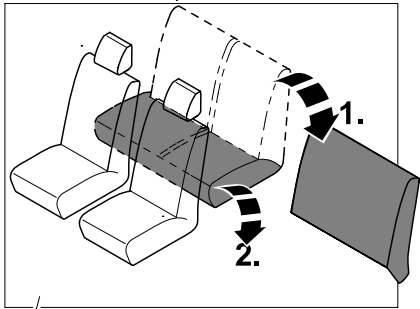
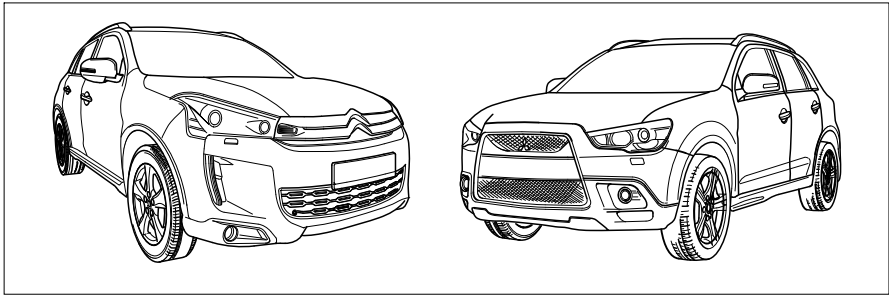

6.

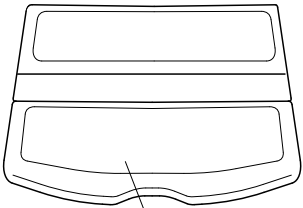
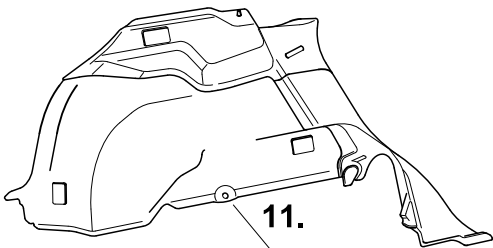

1.

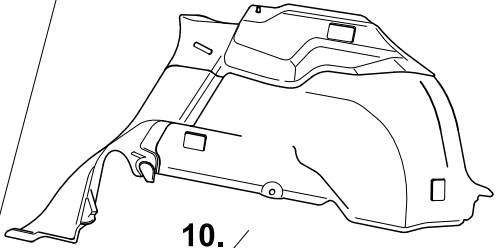

10.

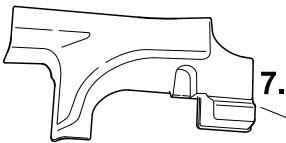

11.

8.

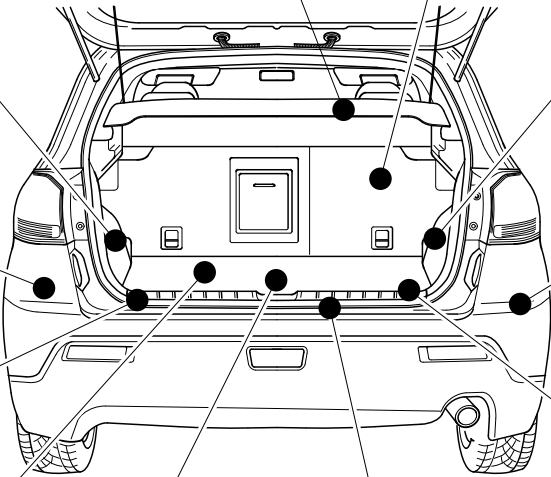

5.

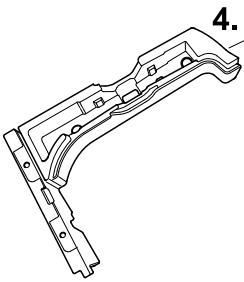

2.

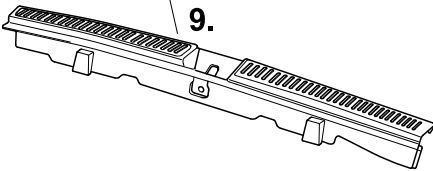

9.

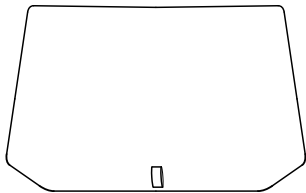

3.

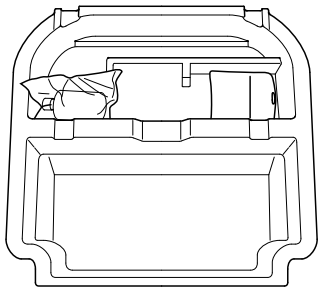

12 mm



14 mm

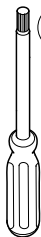
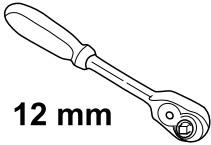

3

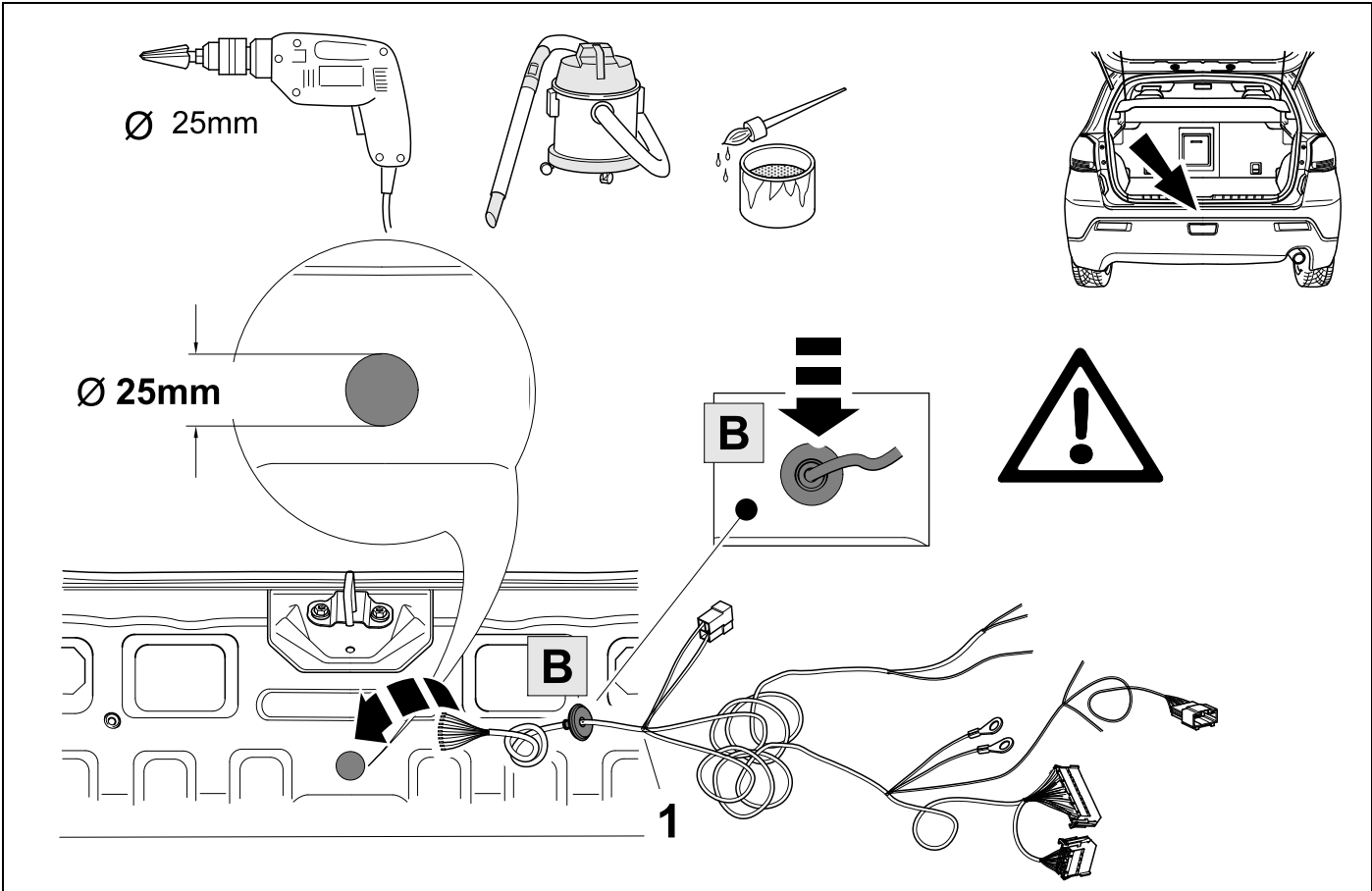

4

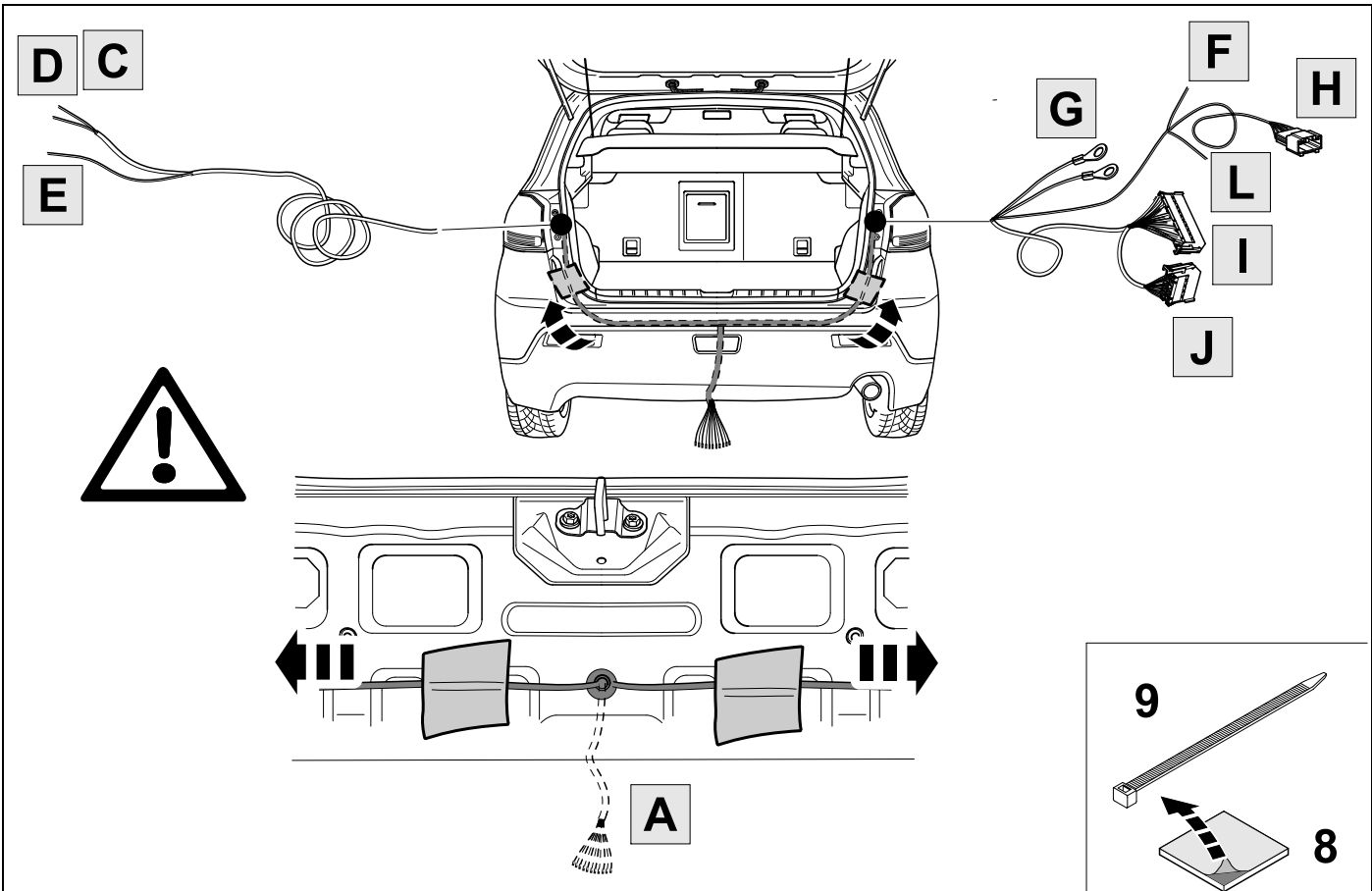

5

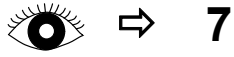

729493

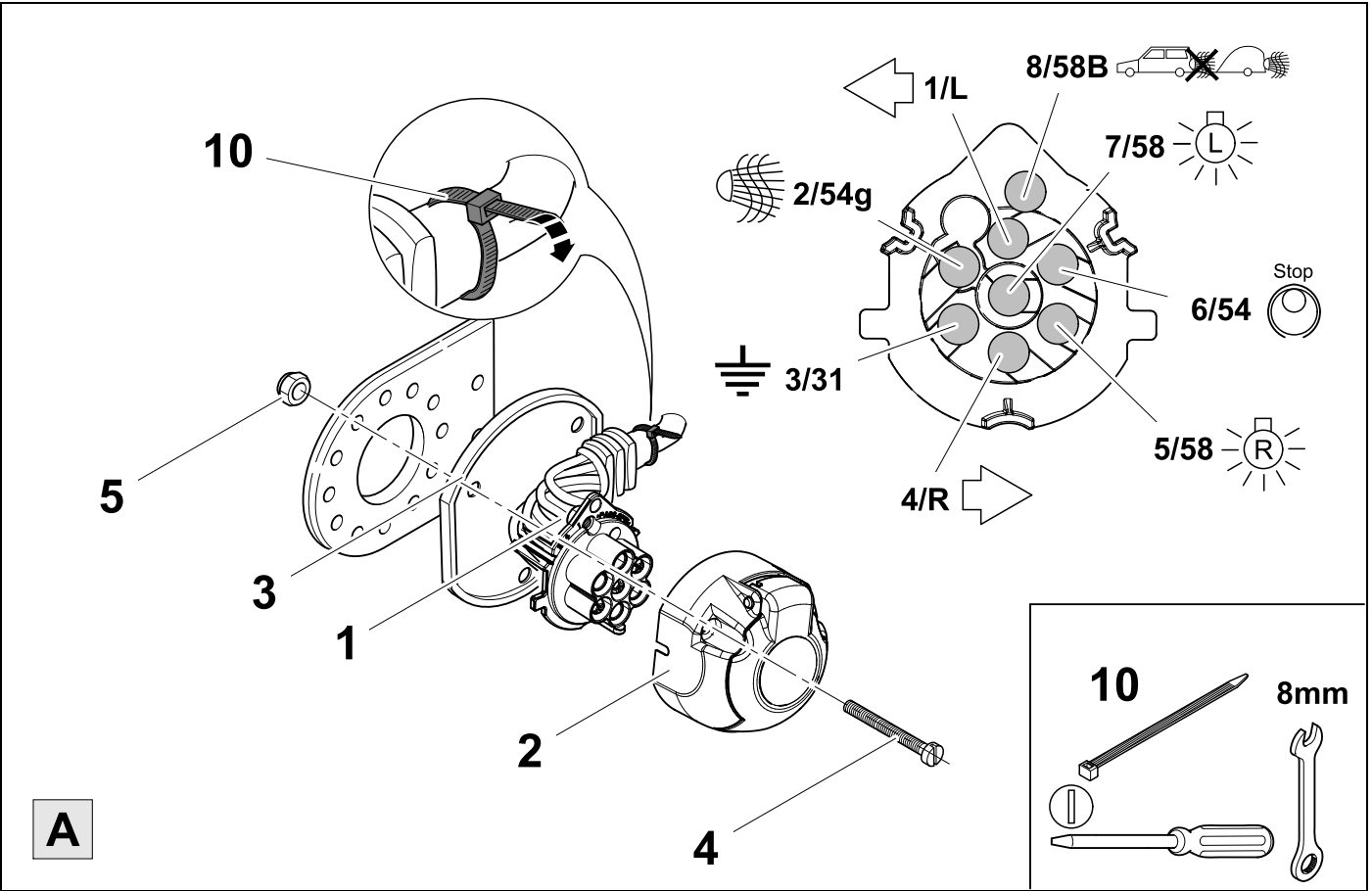







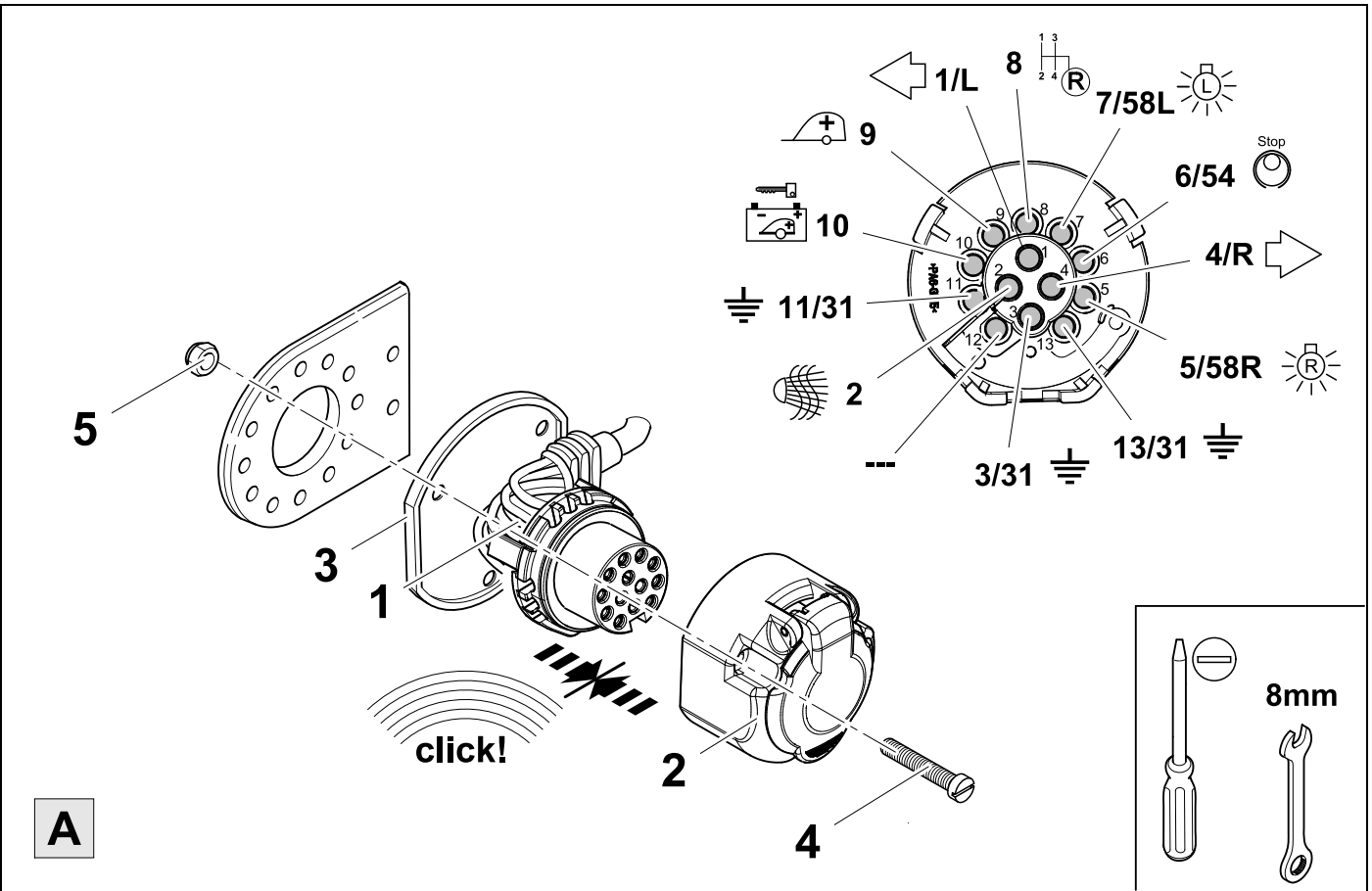



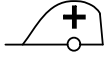

6



729494



7 + 13 PIN			13 PIN		
1	bk/wh		8	bu/rd	
2	gy		9	rd/bu	
3	wh/bn		10	ye	
4	bk/gn		11	bn/gn	
5	gy/rd		12	no	
6	bk/rd		13	bn	
7	gy/bk				

8	bk	wh	gy	gn	rd	bu	ye	bn	pu	or	no
(D)	schwarz	weiss	grau	grün	rot	blau	gelb	braun	violett	orange	nicht belegt
(GB)	black	white	grey	green	red	blue	yellow	brown	purple	orange	not occupied
(F)	noir	blanc	gris	vert	rouge	bleu	jaune	brun	violet	orange	inutilisé
(NL)	zwart	wit	grijs	groen	rood	blauw	geel	bruin	violet	oranje	niet aangesloten
(DK)	sort	hvid	grå	grøn	rød	blå	gul	brun	violet	orange	ikke anvendt
(N)	svart	hvit	grå	grønn	rød	blå	gul	brun	fiolett	oransje	ikke i bruk
(S)	svart	vit	grå	grön	röd	blå	gul	brun	violett	orange	ej använd
(FIN)	musta	valkoinen	harmaa	vihreä	punainen	sininen	keltainen	ruskea	violetti	oranssi	ei varattu
(I)	nero	bianco	grigio	verde	rosso	blu	giallo	marrone	viola	arancione	libero
(E)	negro	blanco	gris	verde	rojo	azul	amarillo	marrón	violeta	anaranja-do	no ocupado
(P)	preto	branco	cinzento	verde	vermelho	azul	amarelo	castanho	violeta	laranja	não ocupado
(GR)	μαύρος	λευκός	Γκρι	πράσινος	κόκκινος	μπλε	κίτρινος	καφέ	Μωβ	πορτοκαλί	δεν είναι κατ'επιτημμένος
(PL)	czarny	biały	szary	zielony	czerwony	niebiesko	żółty	brazowy	fioletowy	pomarańczowy	wolny
(CZ)	černý	bílý	šedý	zelený	červený	modrý	žlutý	hnědý	fialový	oranžový	neobsazen
(TR)	siyah	beyaz	gri	yeşil	kırmızı	mavi	sarı	kahverengi	mor	portakal rengi	boş
(H)	fekete	fehér	szürke	zöld	piros	kék	sárga	barna	ibolyakék	narancssárga	nem foglalt
(HR)	crno	bijelo	sivo	zeleno	crveno	plavo	zuto	smeđe	ljubičasto	narandžasto	nije zauzeto
(BUL)	черен	бял	сив	зелен	червен	син	жълт	кафяв	виолетов	оранжев	свободно
(RO)	negru	alb	gri	verde	roșu	albastru	galben	maro	violet	portocaliu	liber
(RU)	черный	белый	серый	зеленый	красный	голубой	жёлтый	коричневый	пурпурный	оранжевый	свободно
(LT)	juoda	balta	pilka	žalia	raudona	mėlyna	geltona	ruda	purpurinė	oranžinė	laisva
(LV)	melna	balta	pelēka	zaļa	sarkana	zila	dzeltena	brūna	purpur-sarkana	oranža	brīvs
(EST)	must	valge	hall	roheline	punane	sinine	kollane	pruun	purpur-punane	oraanž	vaba
(SLO)	črna	bela	siva	zelena	rdeča	modra	rumena	smeđ	vijoličast	oranžen	ni zasedeno
(SK)	čierny	biely	šedý	zelený	červený	modrý	žltý	hnědý	fialový	pomarančový	neobsadený

9

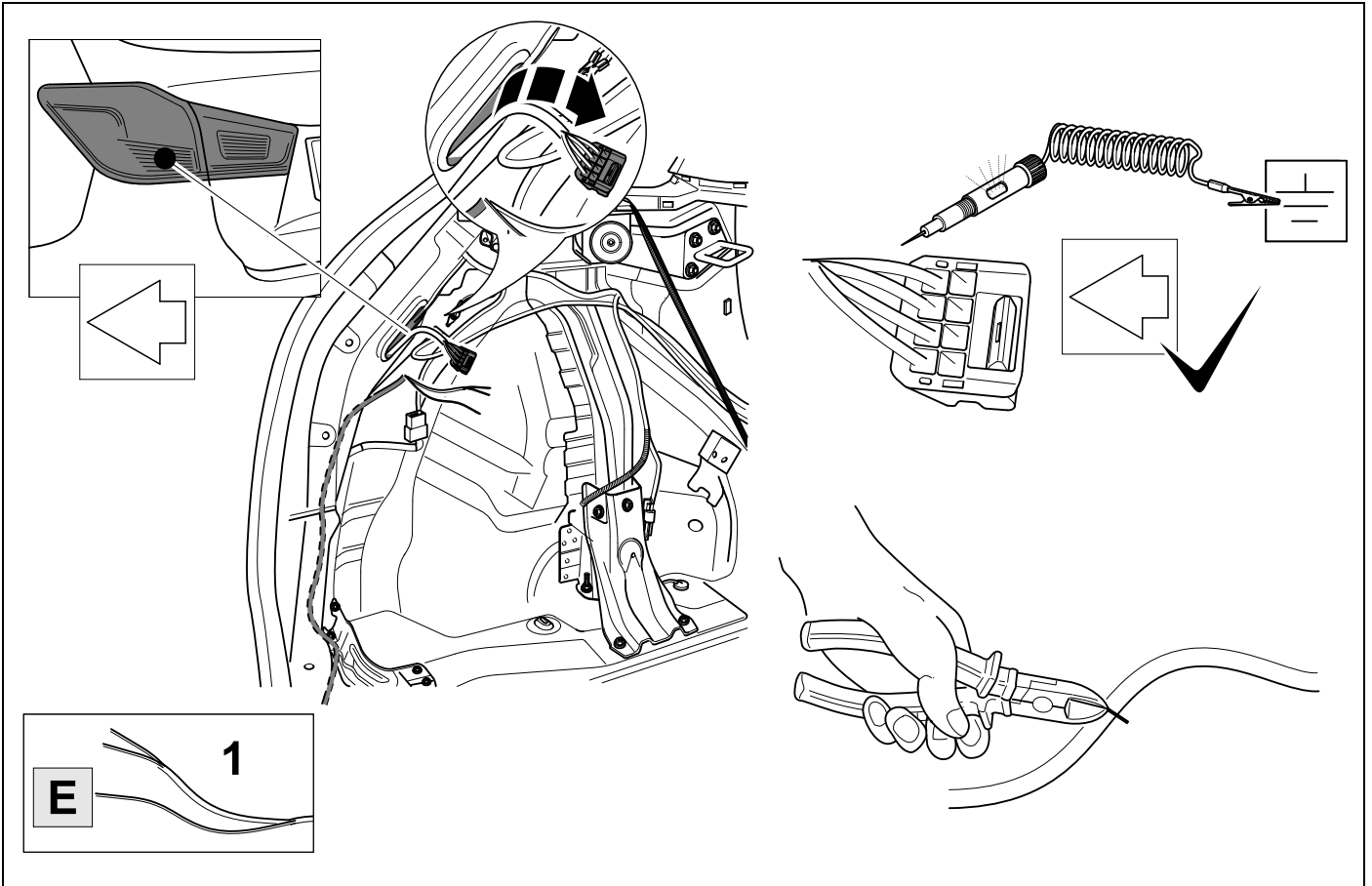

10

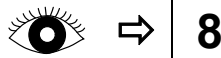

8

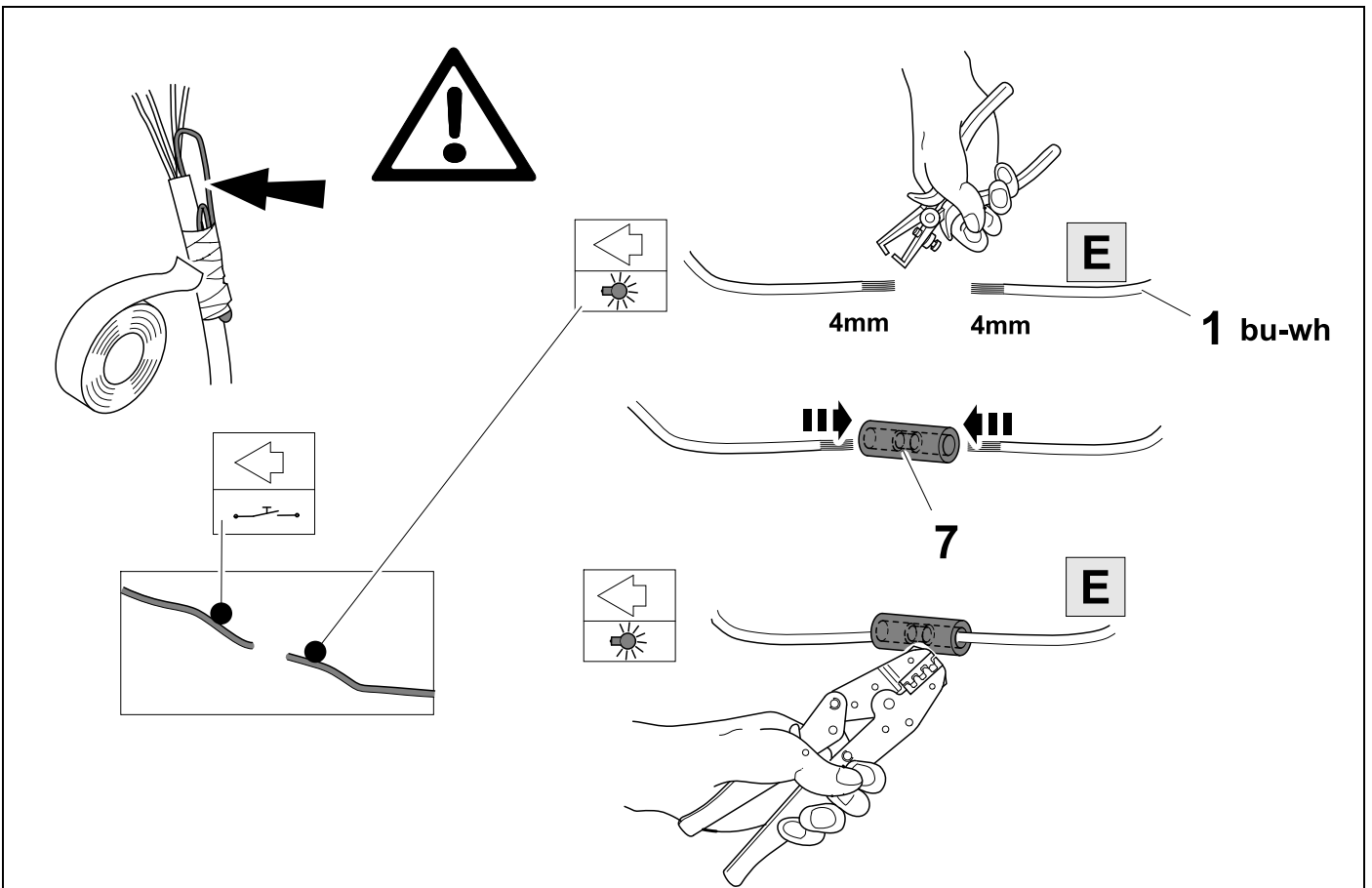

11 Peugeot 4008

Mitsubishi ASX

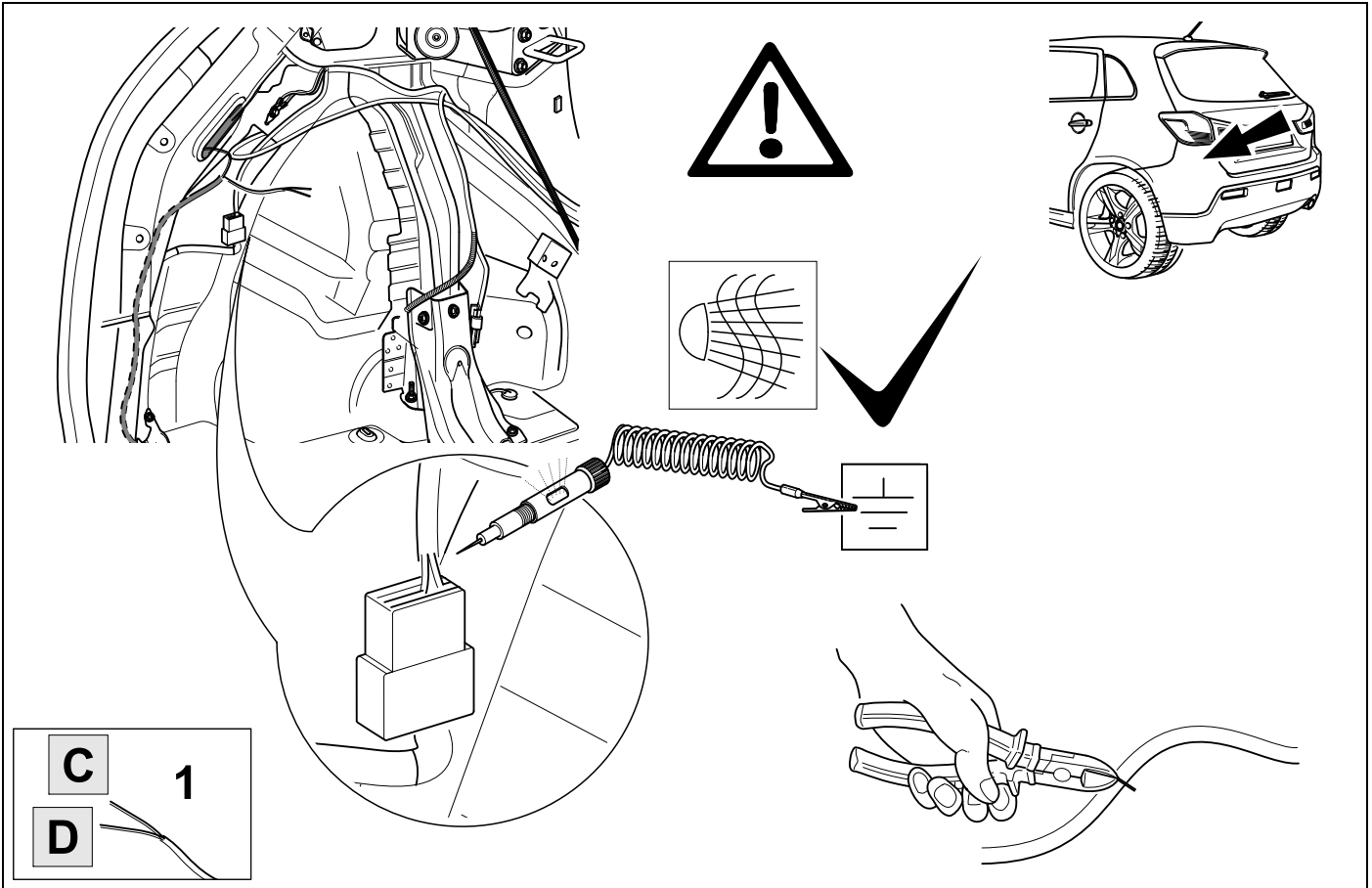

12 Peugeot 4008

👁️ ⇒ 8

Mitsubishi ASX

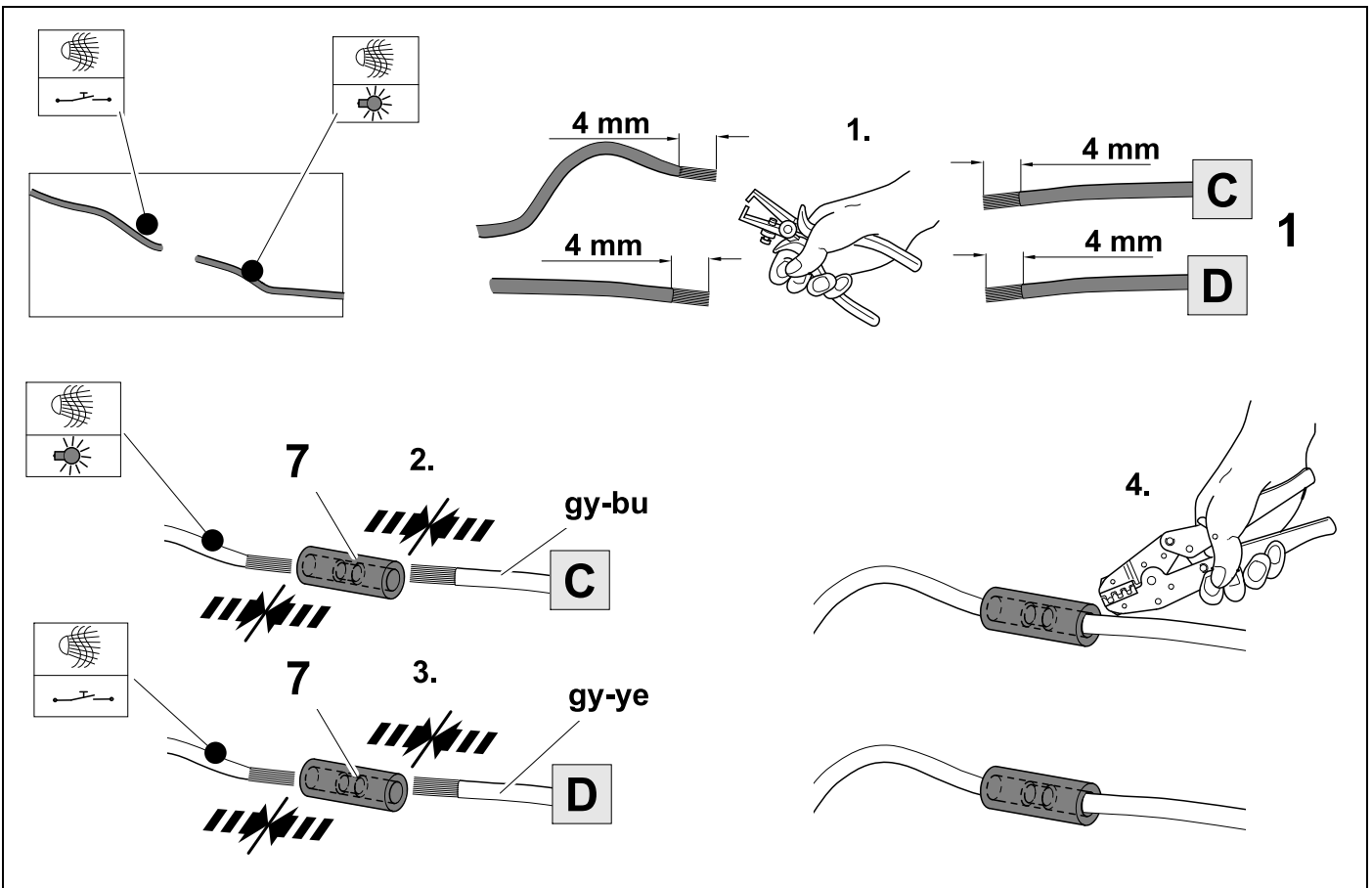

13

C4 Aircross

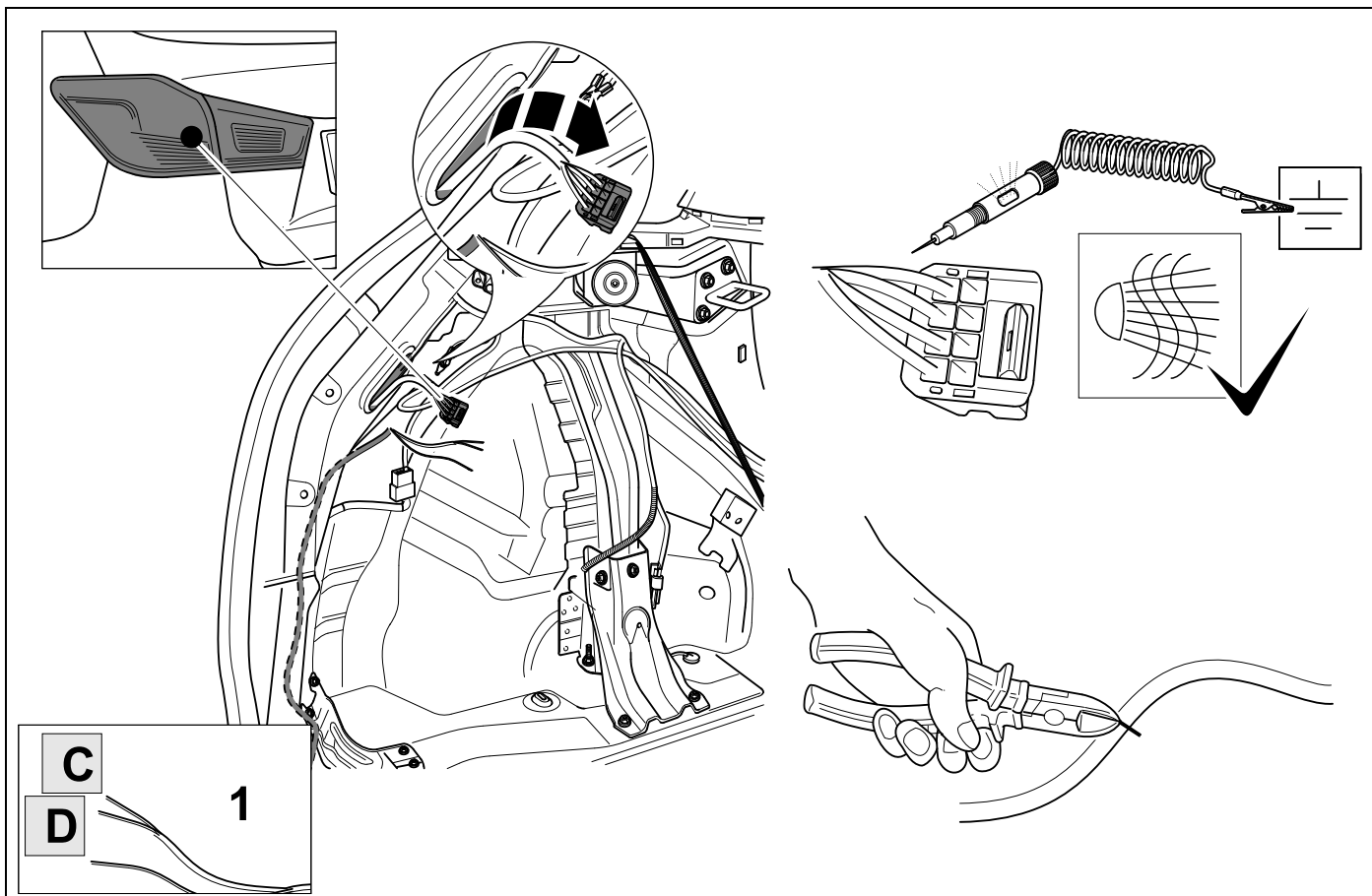

14



8

C4 Aircross

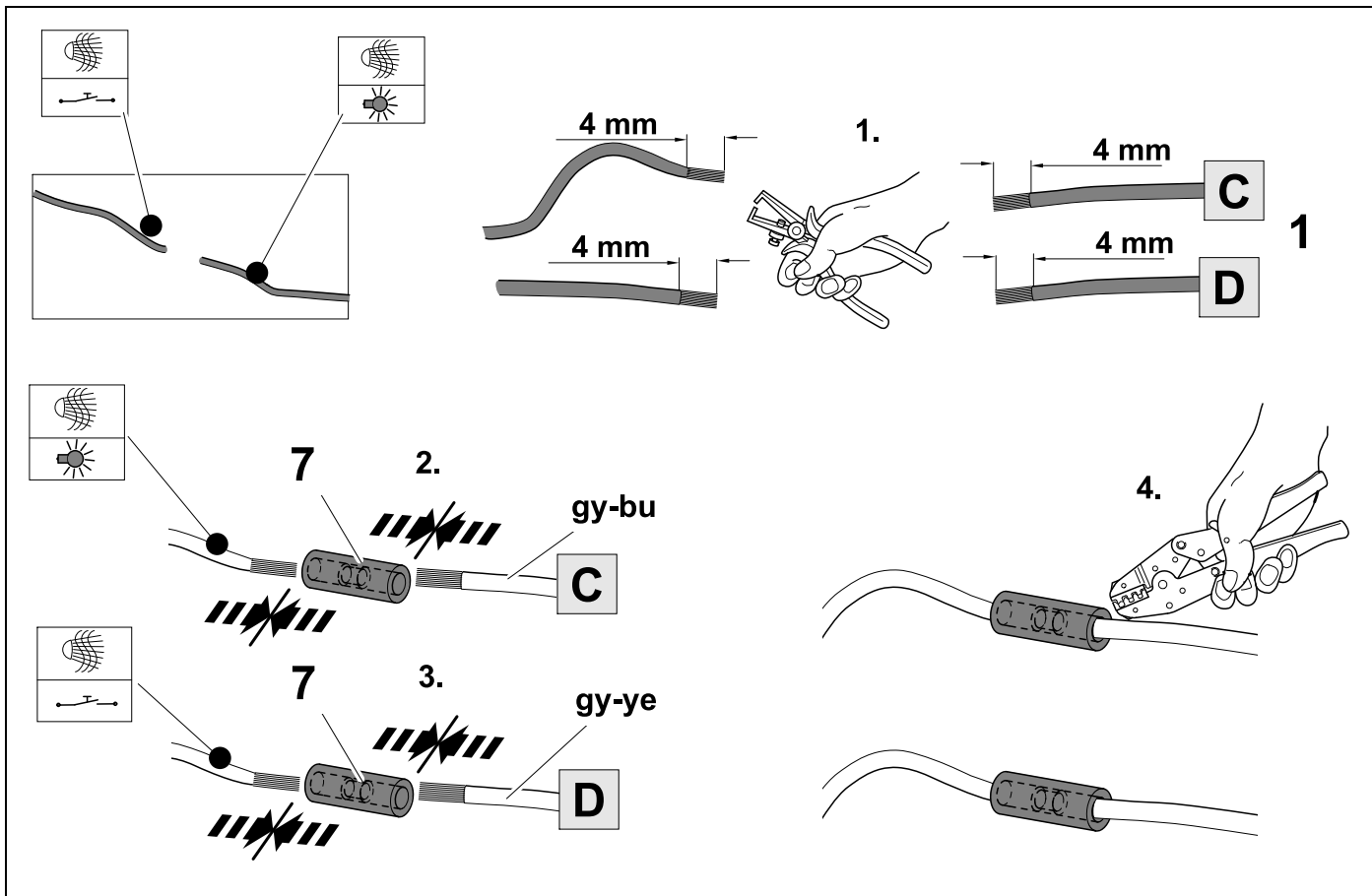

15

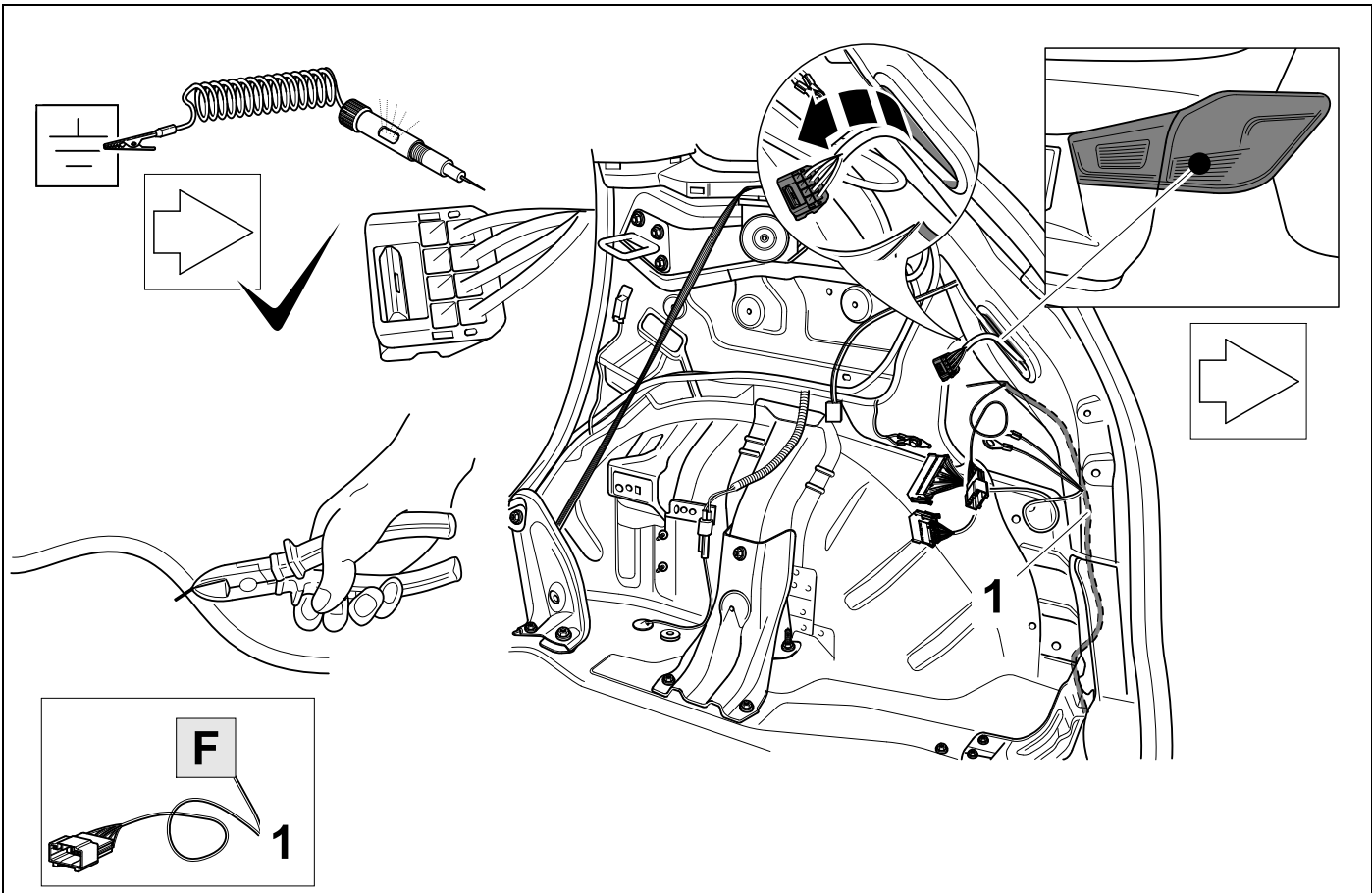

16

👁️ → 8

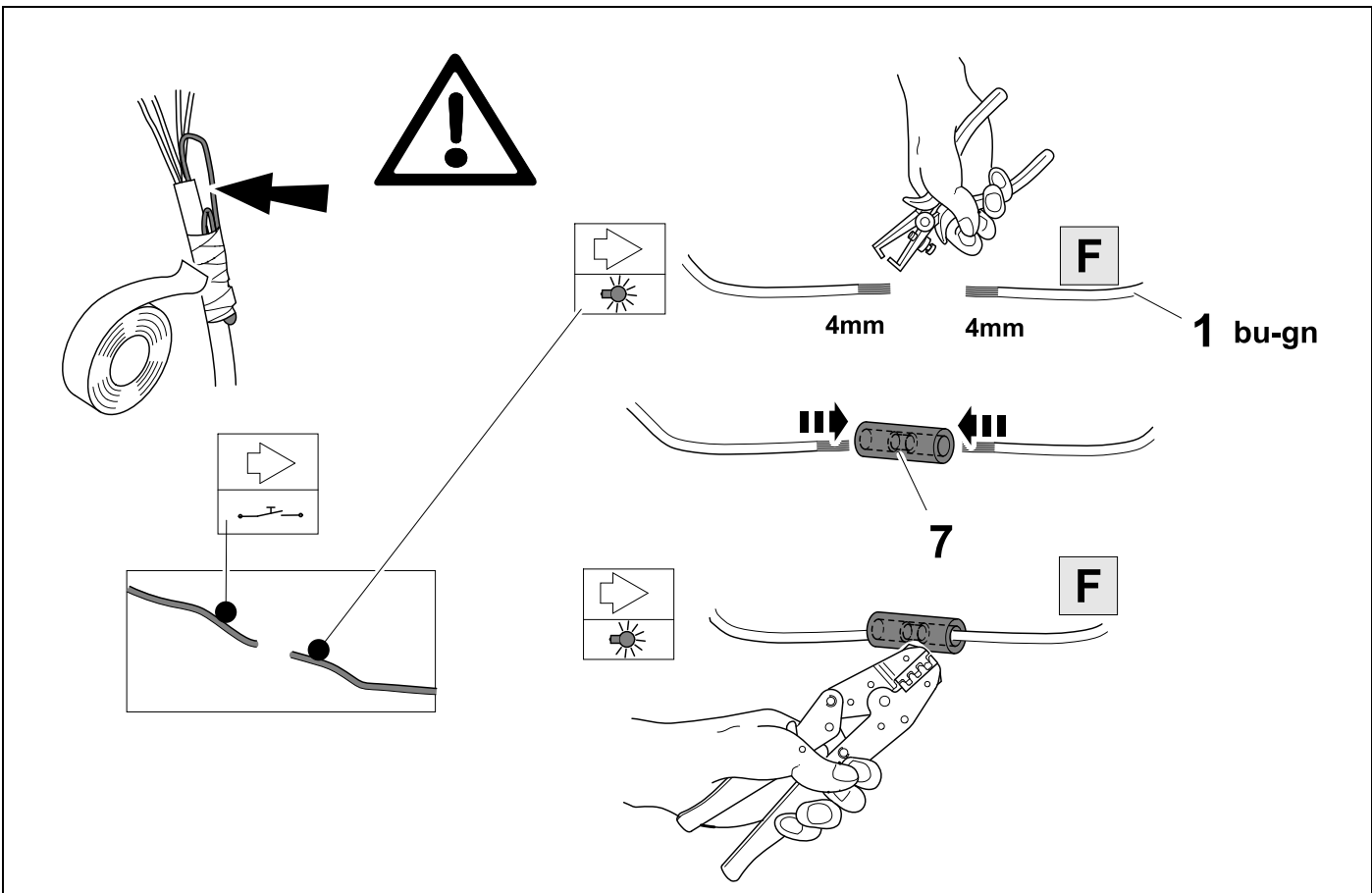

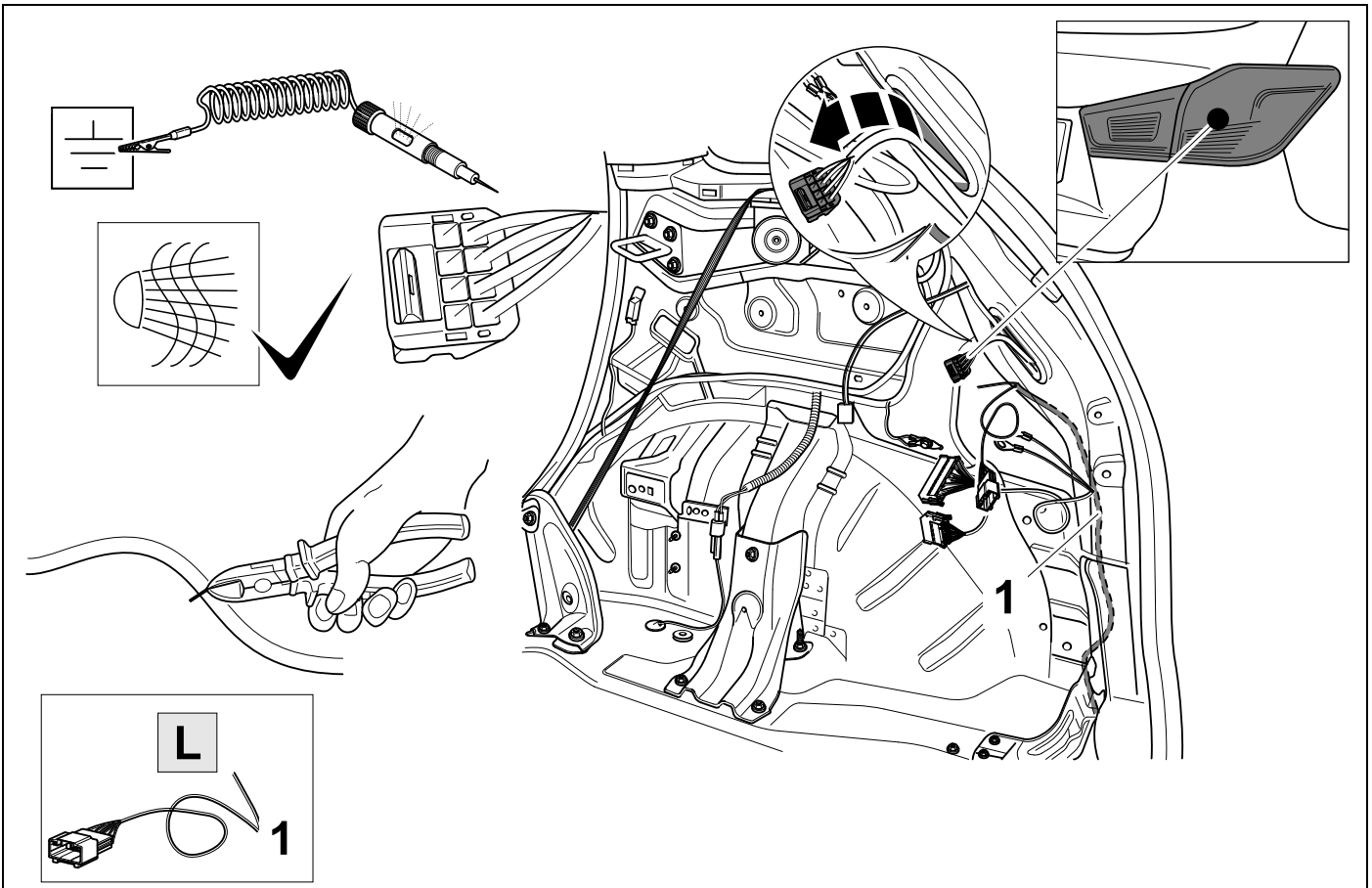
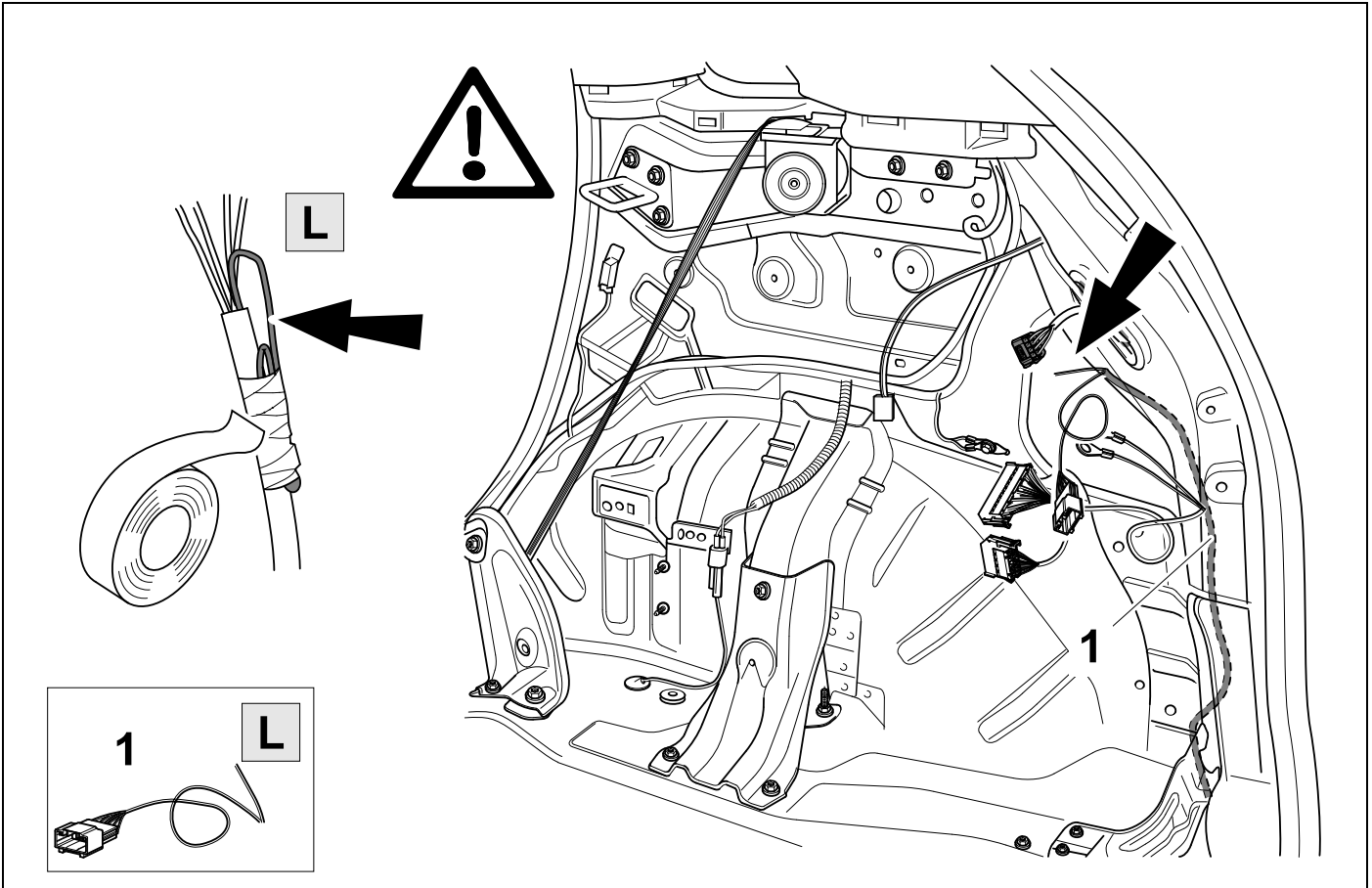

19

8

C4 Aircross

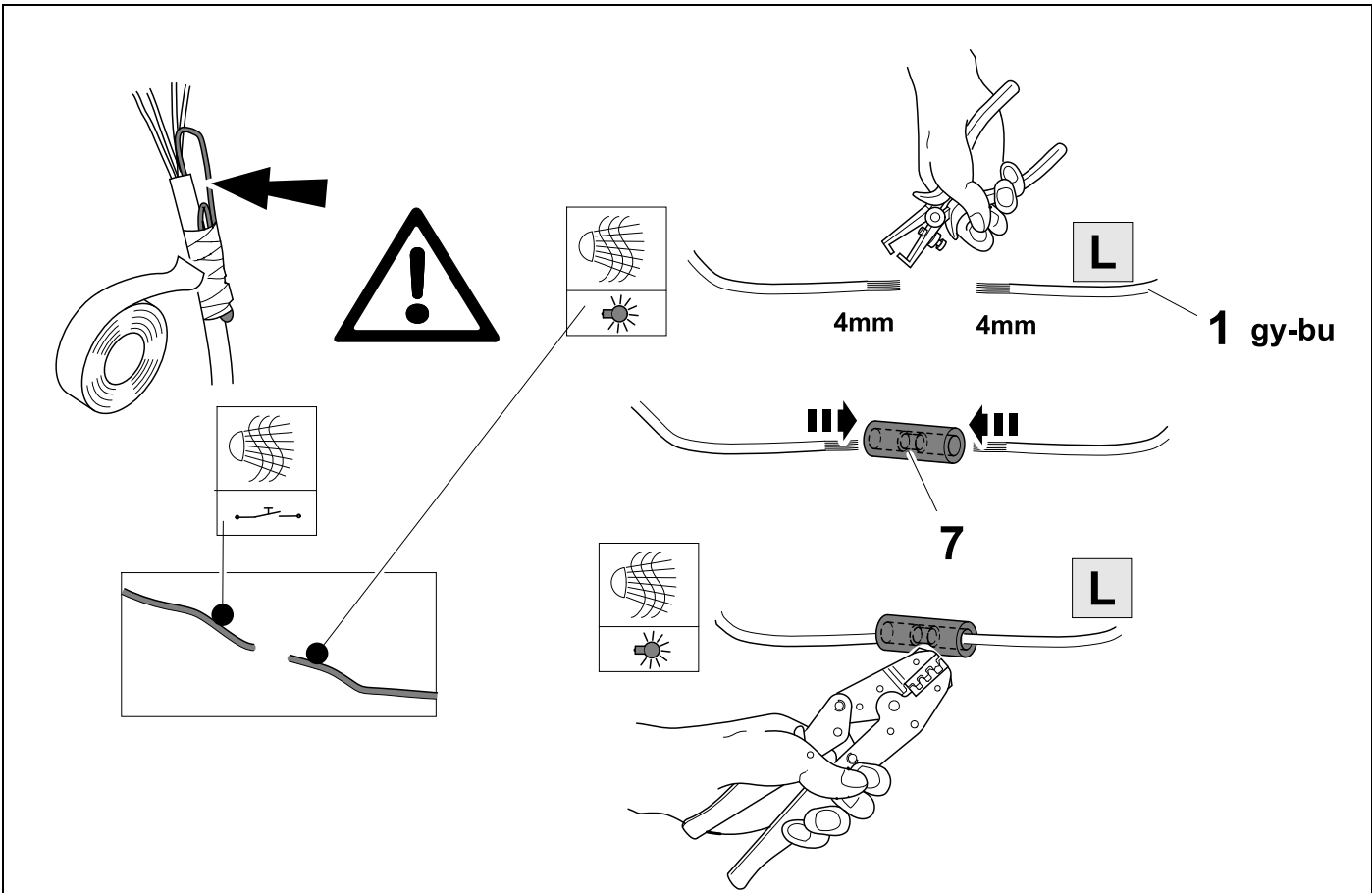

20

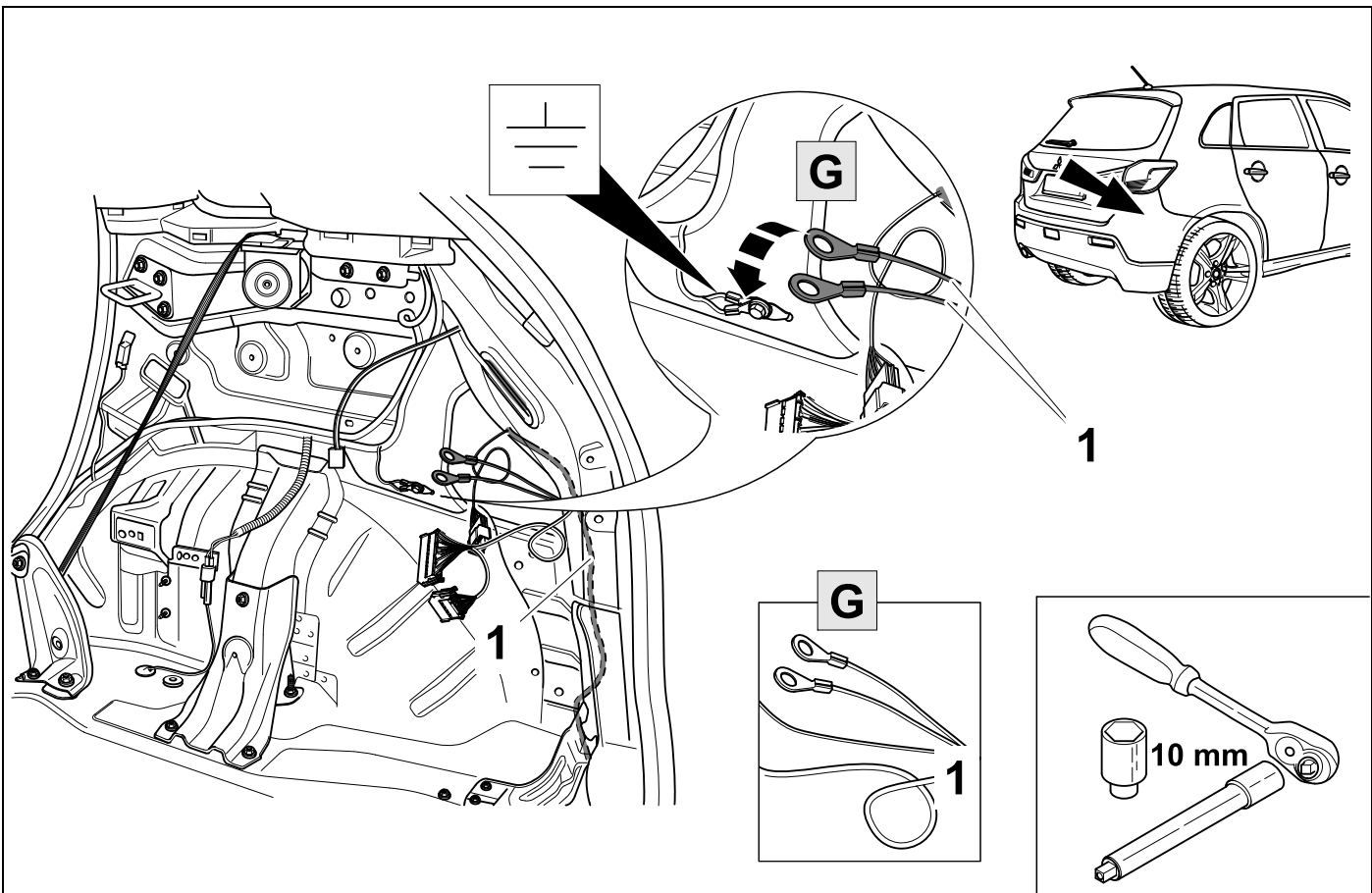

21

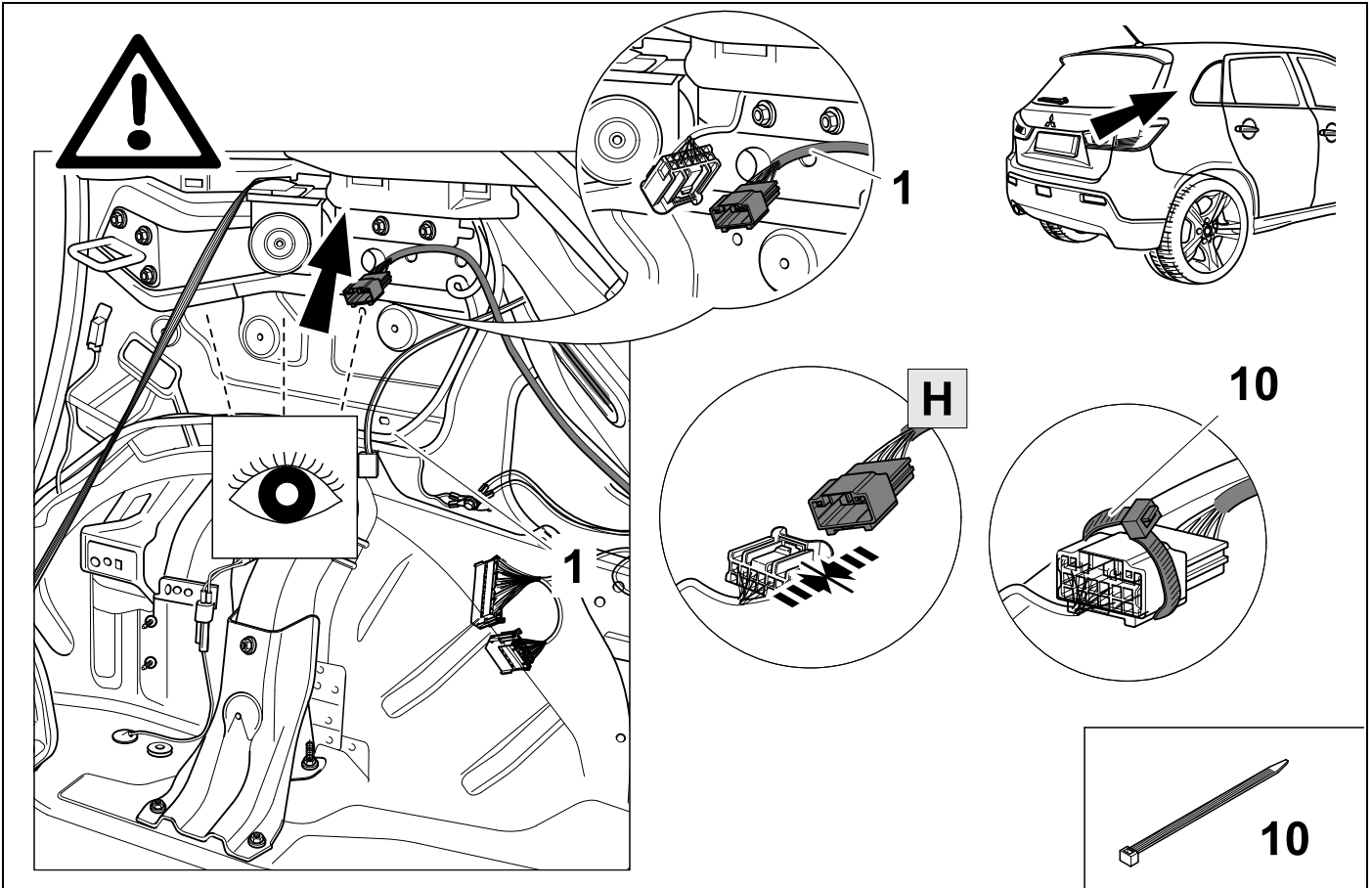

22

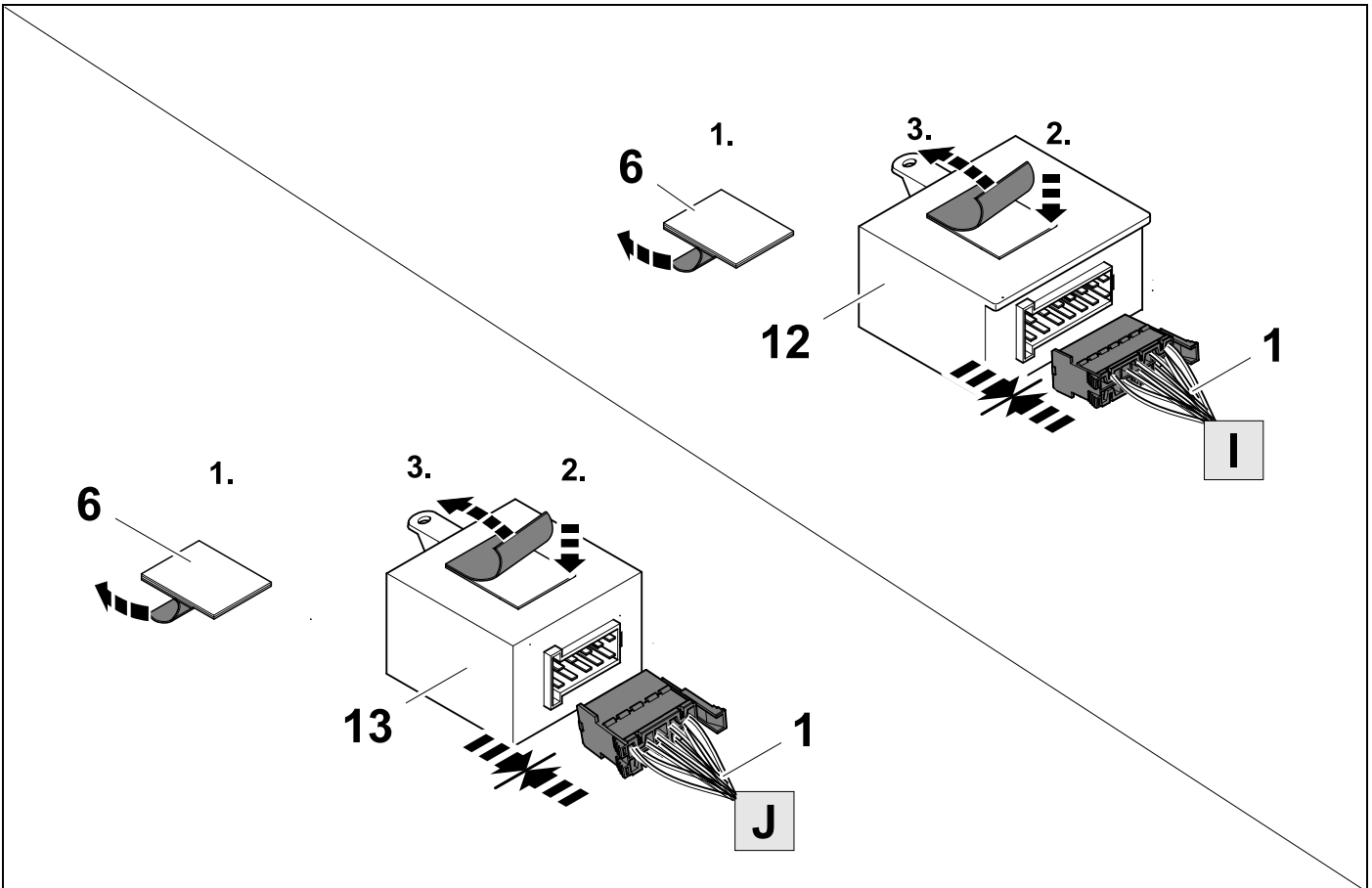

23

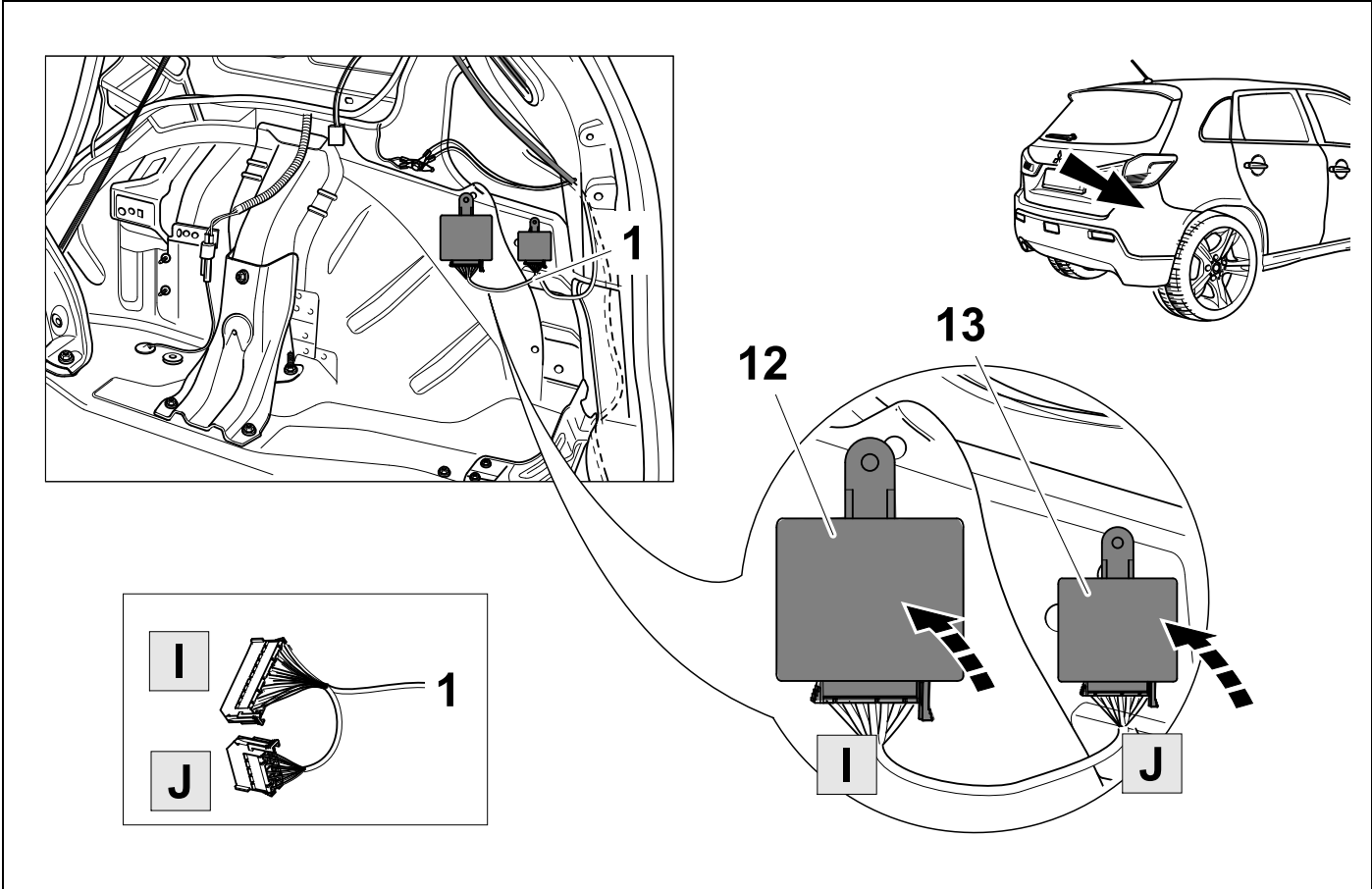

24

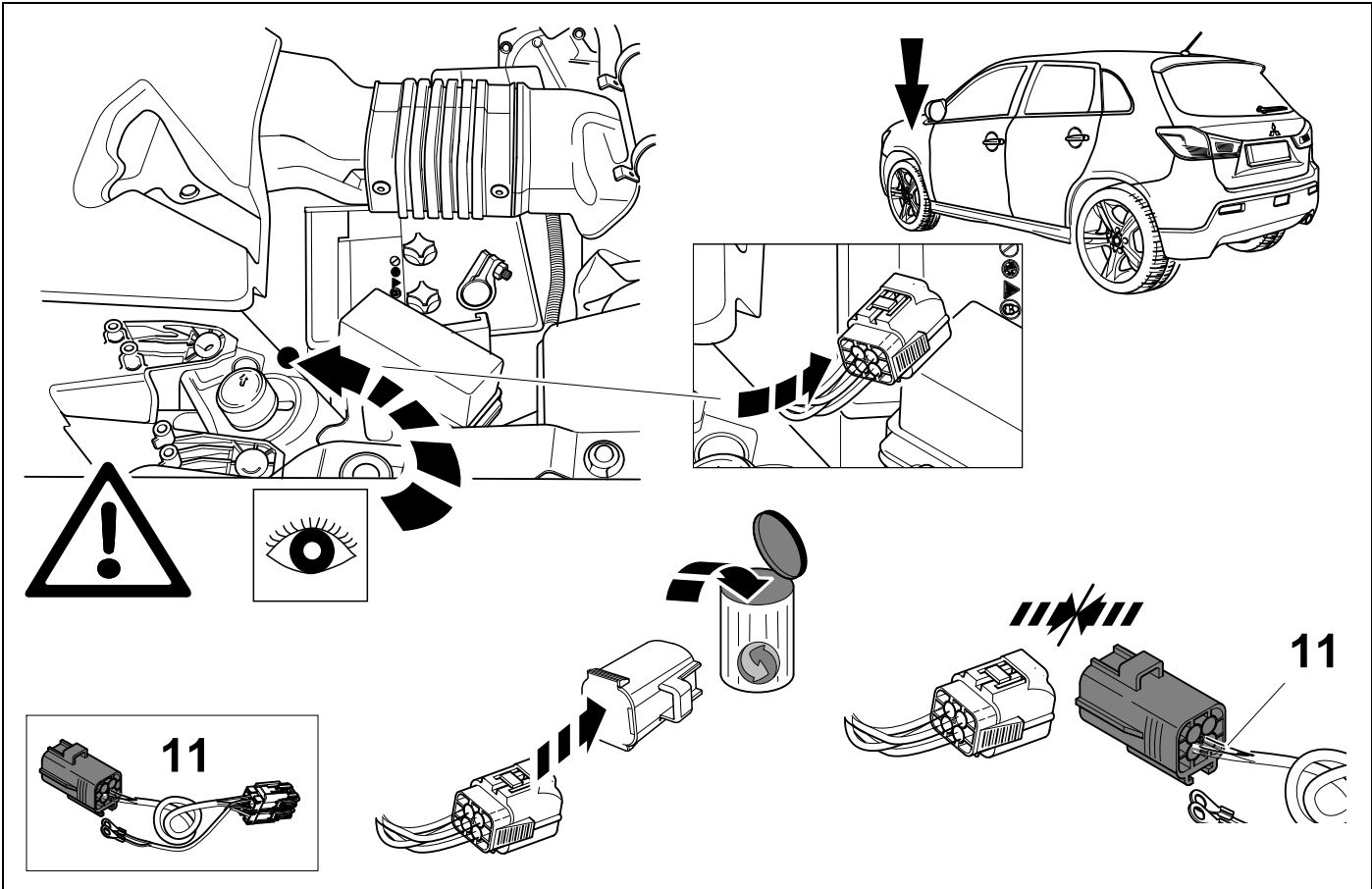

25

👁️ ⇒ 32

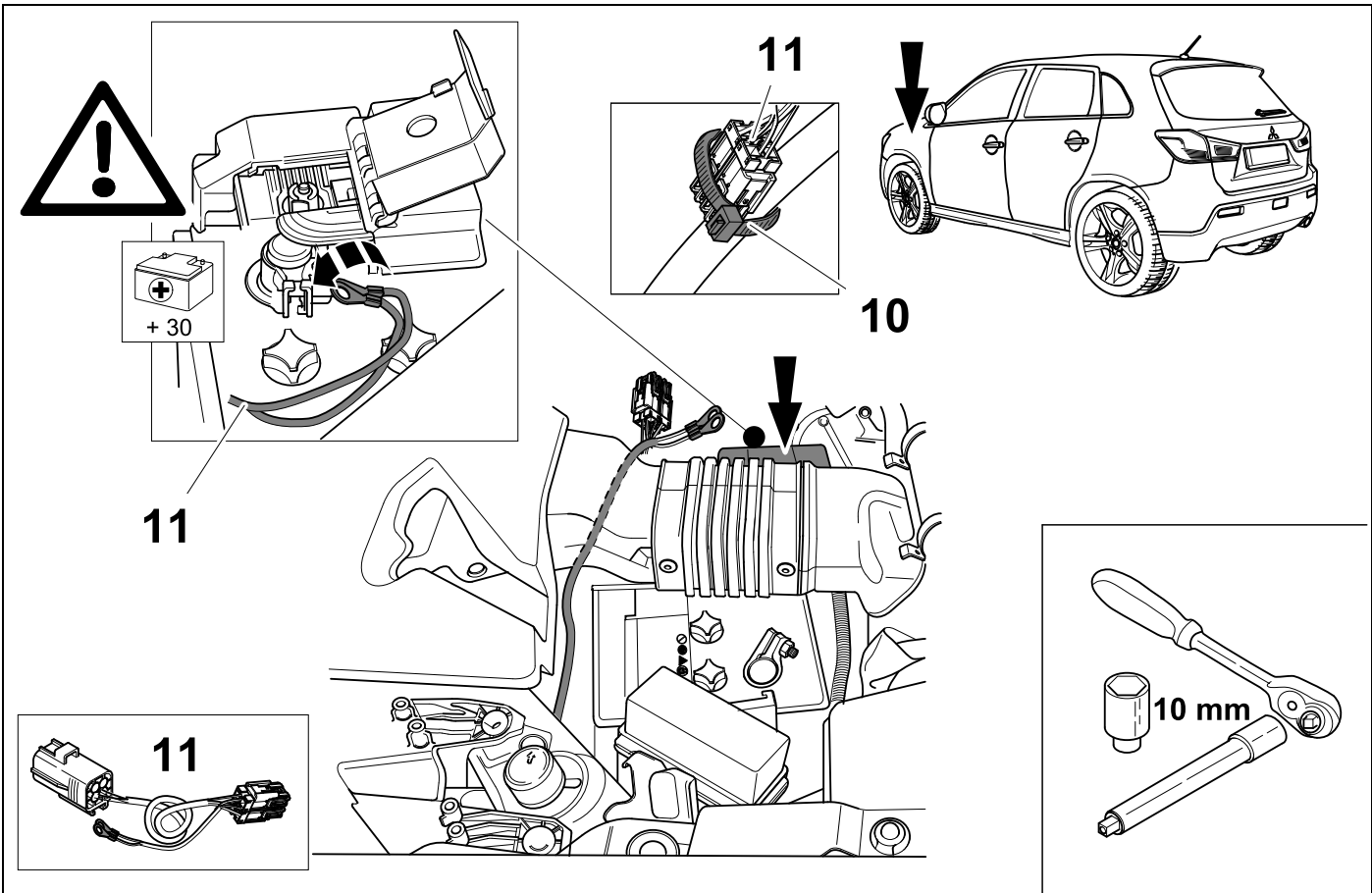

26

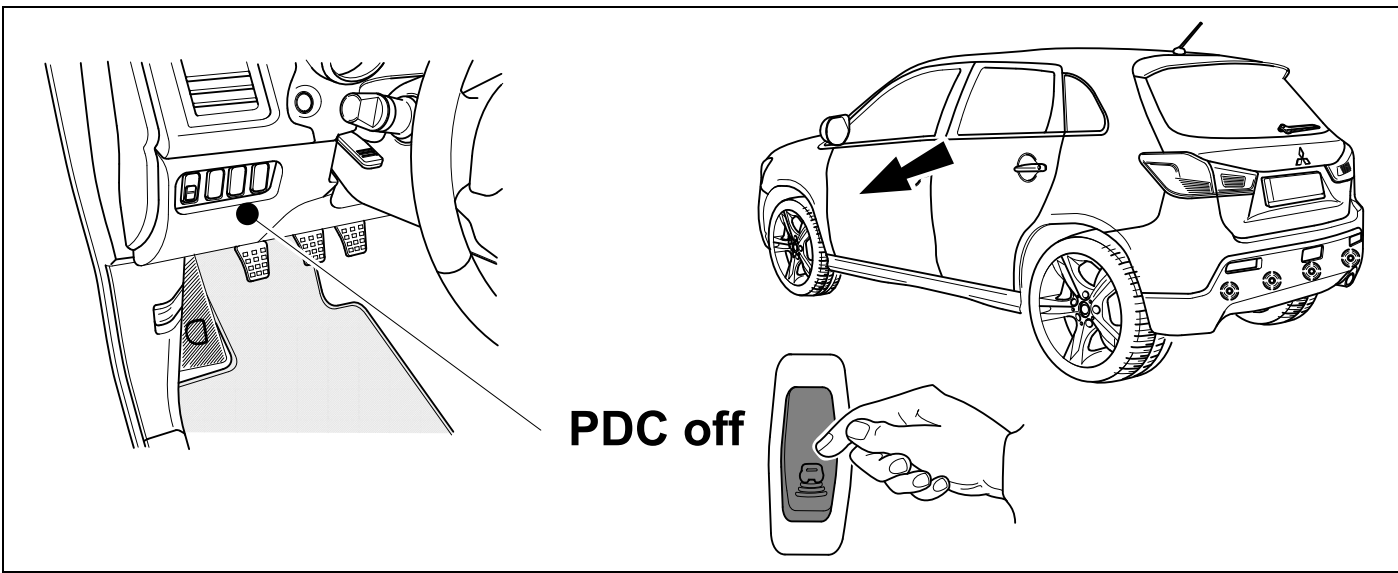

27



THULE
SWEDEN

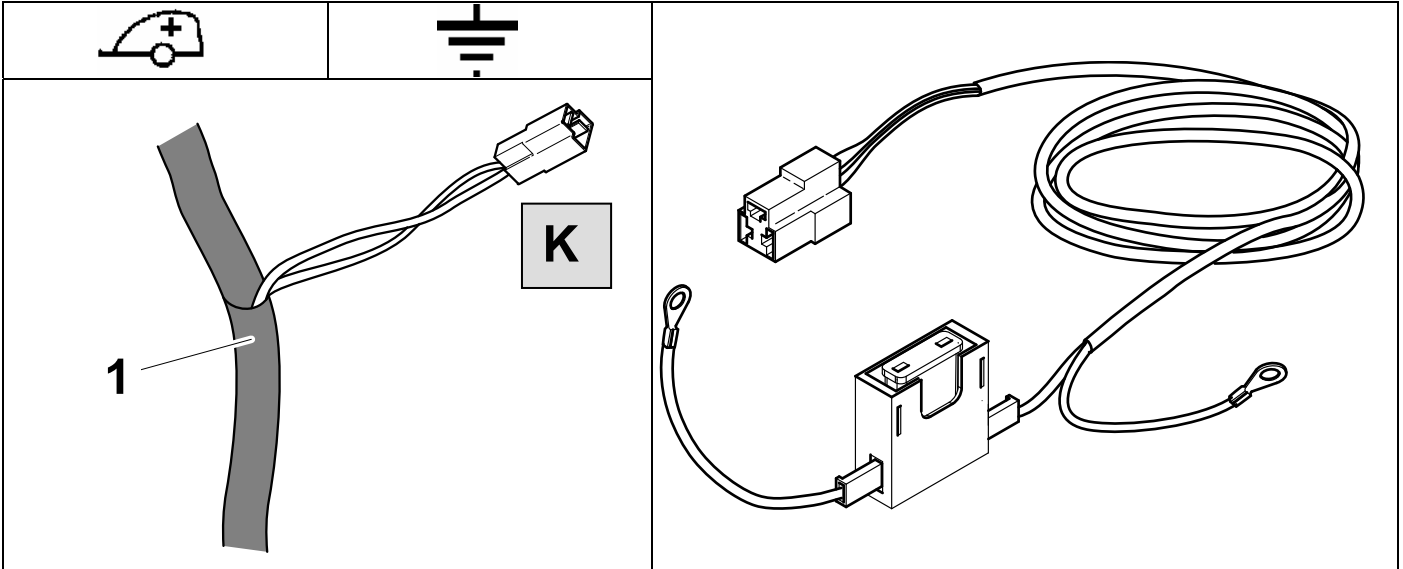

28



THULE
SWEDEN

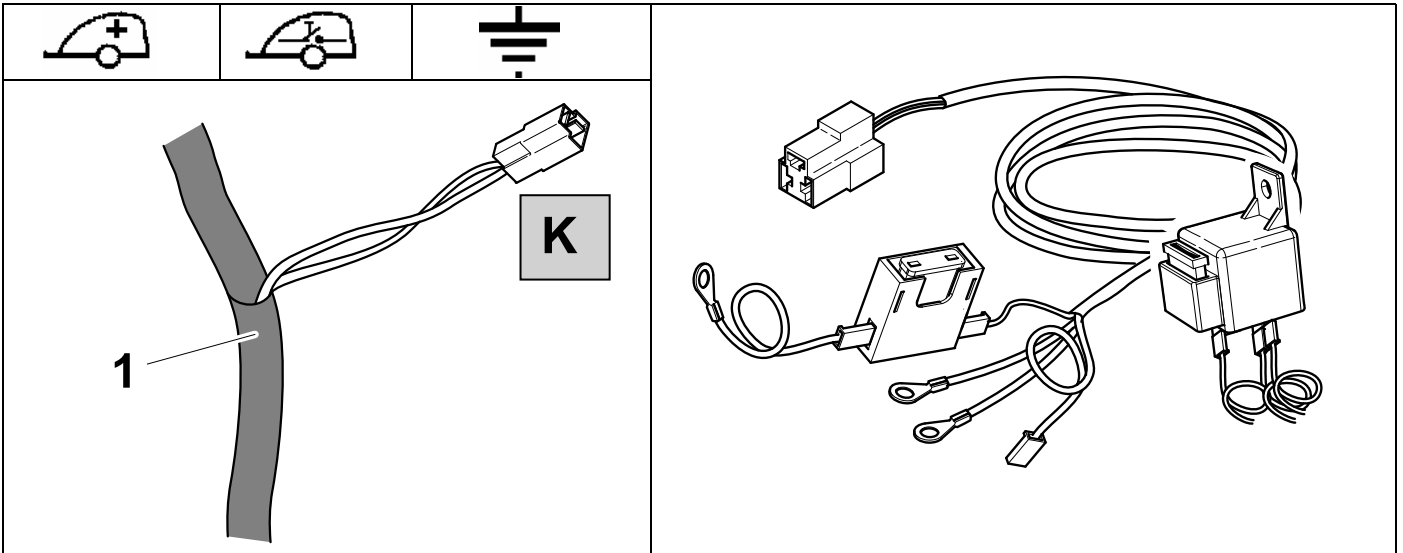

29

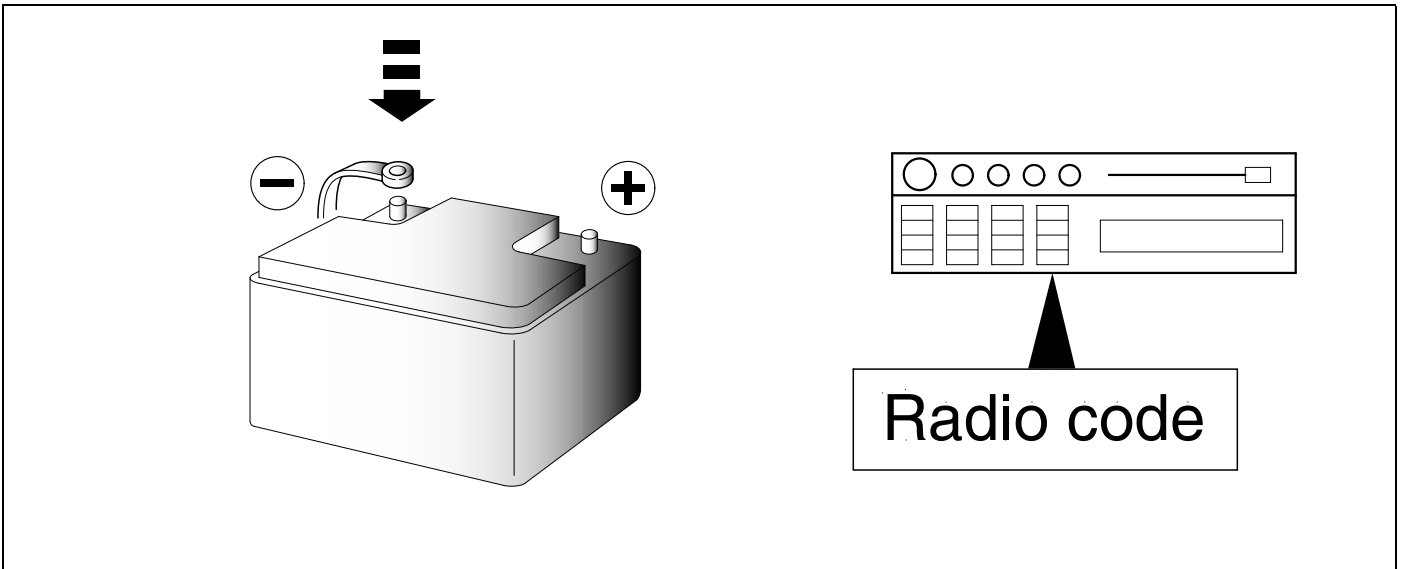

30 CHECK

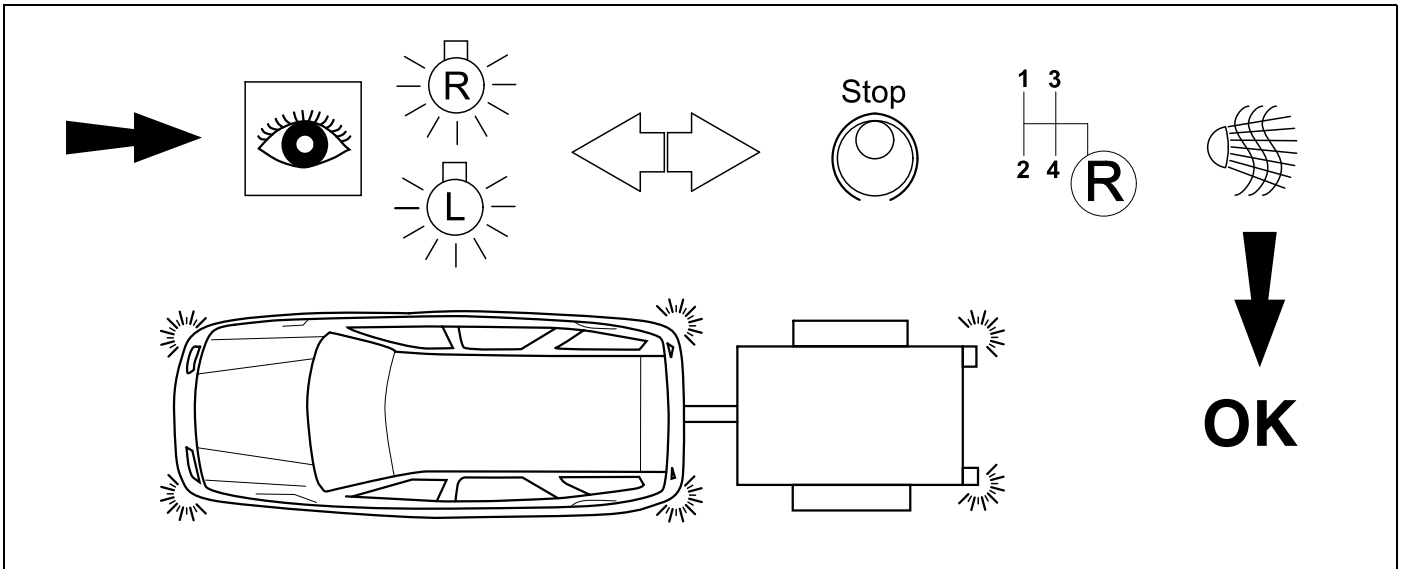

31 CHECK

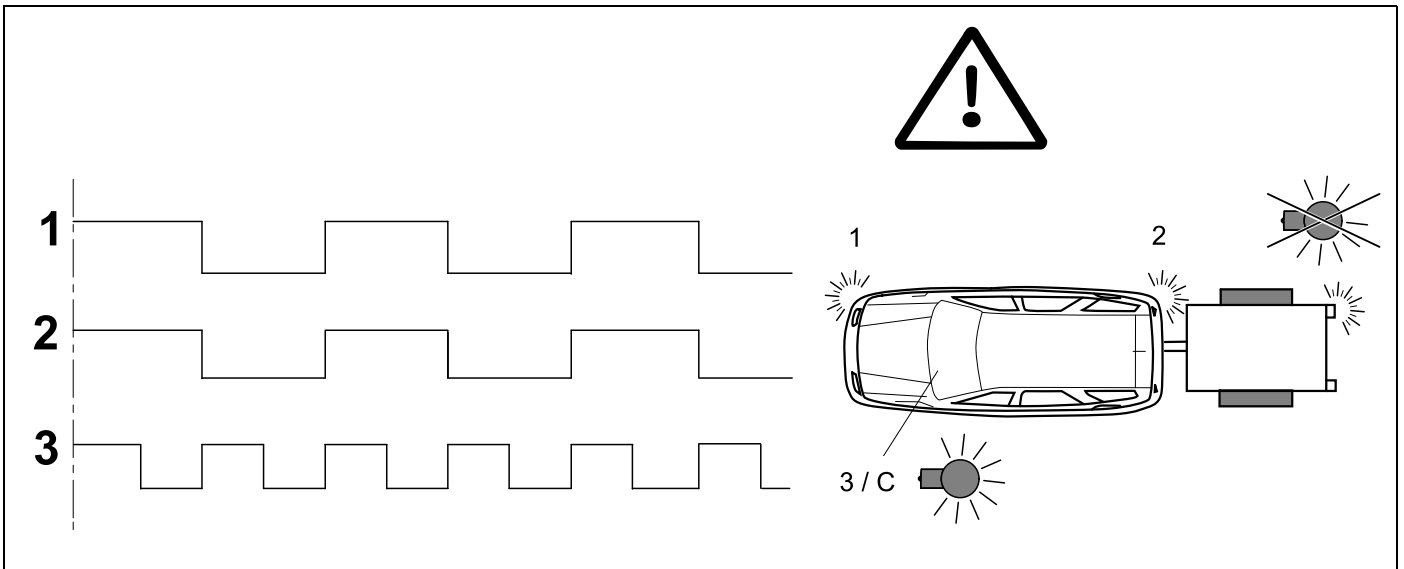

32

👁️ ⇒ 25

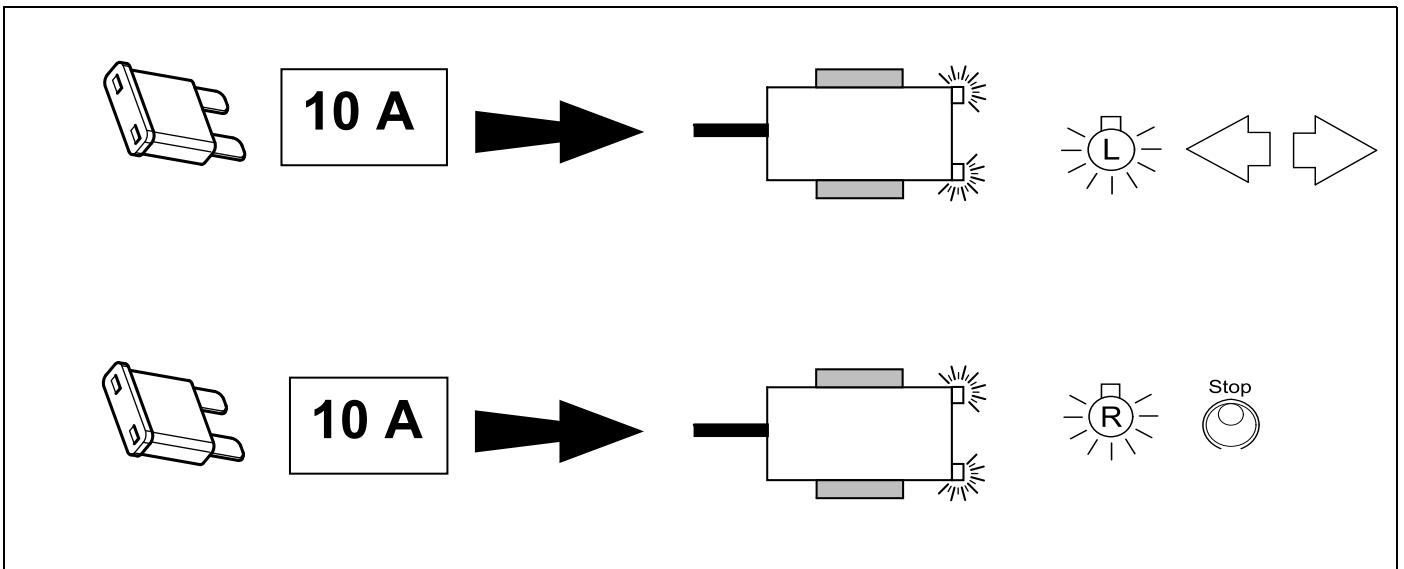

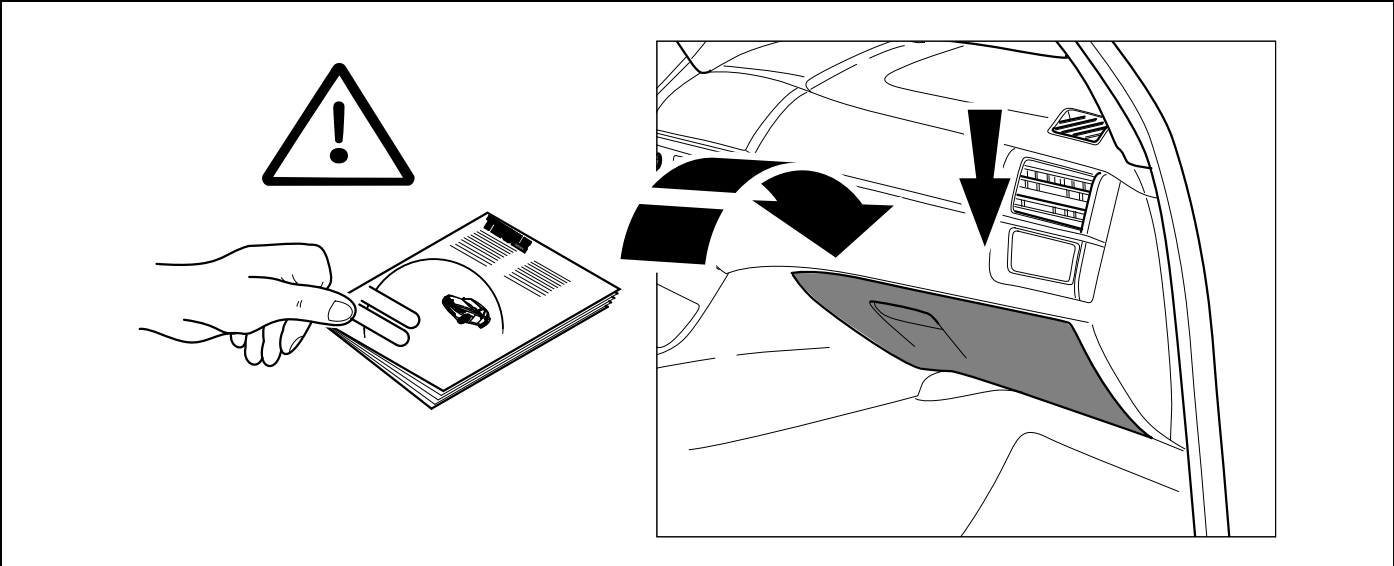

D	Änderungen bezüglich Konstruktion, Ausstattung Farbe sowie Irrtum vorbehalten. Angaben und Abbildungen unverbindlich	PL	Zastrzega się prawo do zmian dot. konstrukcji, wykończenia, kolorystyki oraz pomyłek. Dane i ilustracje niewiążące.
GB	Subject to change in terms of construction, equipment and colour, and may contain errors. The information and illustrations are non-binding.	TR	Tasarım, donanım ve renk bakımından değışiklik yapma hakkı ve hata ve eksiklik mahfuzdur. Veriler ve resimler bağlayıcı değildir.
F	Sous réserve de modifications de la construction, de équipement, de la couleur et sous réserve d'erreurs. Les indications et les illustrations sont sans engagement.	H	A szerkezet, a kivitel és a szín változtatása, valamint a változások joga fenntartva. Az adatok és az ábrák nem kötelező érvényűek.
NL	Wijzigingen met betrekking tot constructie, uitvoering en kleur evenals vergissingen voorbehouden. Gegevens en afbeeldingen niet bindend.	HR	Pravo promjena u svezi konstrukcije, opreme, boje kao i zabune oridžavamo. Podaci i ilustracije su neobavezne.
DK	Ændringer med hensyn til konstruktion, udstyr, farver samt fejl forbeholdes. Oplysninger og illustrationer er uforpligtende.	BUL	Запазени права по отношение на конструкцията, обзавеждането, цвета и грешки. Данните и изображенията не са обвързващи.
N	Ændringer angående konstruksjon, utstyr, farge og feiltagelse forbeholdes. Opplysninger og illustrasjoner uforbindtlig.	RO	Ne rezervăm dreptul unor modificări ale construcției, dotării, culorii și dreptul la erori Datele indicate și imaginile sunt orientative.
S	Med reservation för ändringar vad det gäller konstruktion, utrustning, färg samt för misstag. Uppgifterna och bilderna är inte bindande.	RU	Права на внесение изменений относительно конструкции, оснащения, окраски, а также на ошибки сохраняются. Данные и иллюстрации имеют примерный характер.
FIN	Pidätämme oikeuden rakennetta, varustusta, väriä koskeviin sekä erehdyksestä johtuviin muutoksiin. Tiedot ja kuvat eivät ole sitovia.	LT	Pasiliekaama konstrukcijos, įrangos bei reikmenų, spalvos pakeitimų ir klaidų teisė. Duomenys ir iliustracijos neįpareigojantys.
I	Con riserva di modifiche relative a progettazione, dotazione, colore ed errori. Le indicazioni e figure sono fornite senza impegno.	LV	Tiek paturētas tiesības uz konstrukcijas, iekārtu, krāsu izmaiņām, kā arī kļūdīšanās. Dati un attēli bez saistībām.
E	Reservadas las modificaciones respecto a diseño, equipamiento, color, así como error. Indicaciones y figuras sin compromiso.	EST	Konstruksiooni, varustuse ja võervi osas muudatused ning eksimine lubatud. Andmed ja joonised on mittesiduvad.
P	Reservamos o direito de alterações relativamente ao desenho, equipamento, cor, bem como de erro. Os dados e as gravuras não implicam compromisso da nossa parte.	SLO	Zadržana pravica do sprememb glede konstrukcije, opreme, barve ter pomote. Podatki in slike so neobvezne.
GR	Διατηρώνουμε κάθε επιφύλαξη ως προς αλλαγές σε σχέση με κατασκευή, εξοπλισμό, διαρρύθμιση, χρωματισμούς και λάθη παραδρομής.	SK	Zmeny, ktoré sa týkajú konštrukcie, vybavenia, farby, ako aj omyly sú vyhradené. Údaje a zobrazenia sú nezáväznú.
CZ	Změny, týkající se konstrukce, vybavení, barvy, jakož i omyly jsou vyhrazeny. Údaje a vyobrazení jsou nezáväznú.		