

# Wiringkit



- D Einbauanleitung
- GB Installation instructions
- F Consignes de montage
- NL Montagehandleiding
- DK Montagevejledning
- N Monteringsinstruksjon
- S Installationsanvisning
- FIN Asennusohje
- I Istruzioni per il montaggio
- E Instrucciones de montaje
- P Instruções de montagem
- GR Οδηγίες εγκατάστασης
- CZ Návod k montáži
- SLO Navodilo za vgradnjo
- SK Montážny návod
- PL Instrukcja montażu
- TR Montaj talimatı
- H Beépítési útmutató
- HR Upute o ugradnji
- BUL Инструкция за монтаж
- RO Instrucțiuni de montaj
- RU Инструкция по монтажу и установке
- LT Montavimo informacija
- LV Iemontēšanas pamācība
- EST Paigaldusjuhend

## 703543 BMW

- **3 series Limousine**    **G20**    03/19 >>
- **3-series Touring**    **G21**    07/19 >>

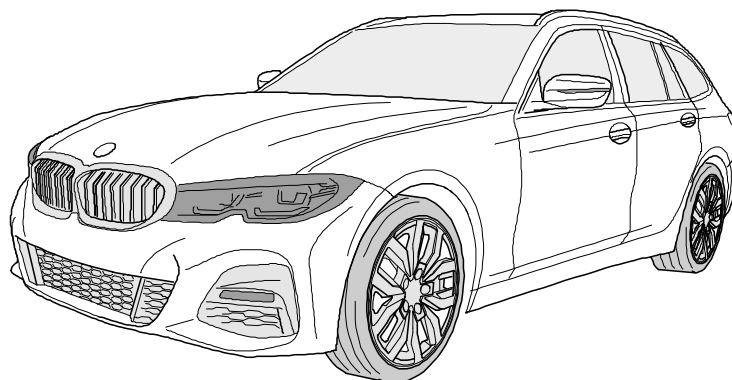
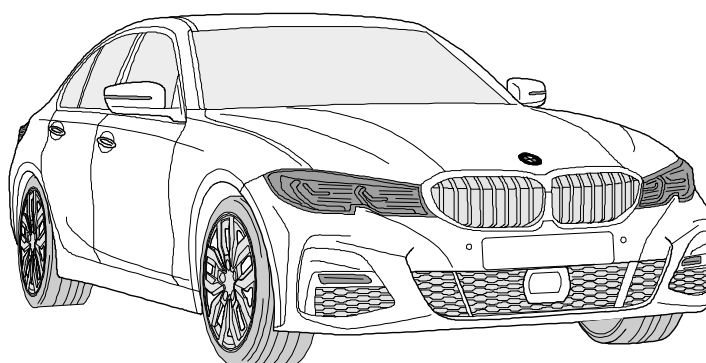

# OVERVIEW

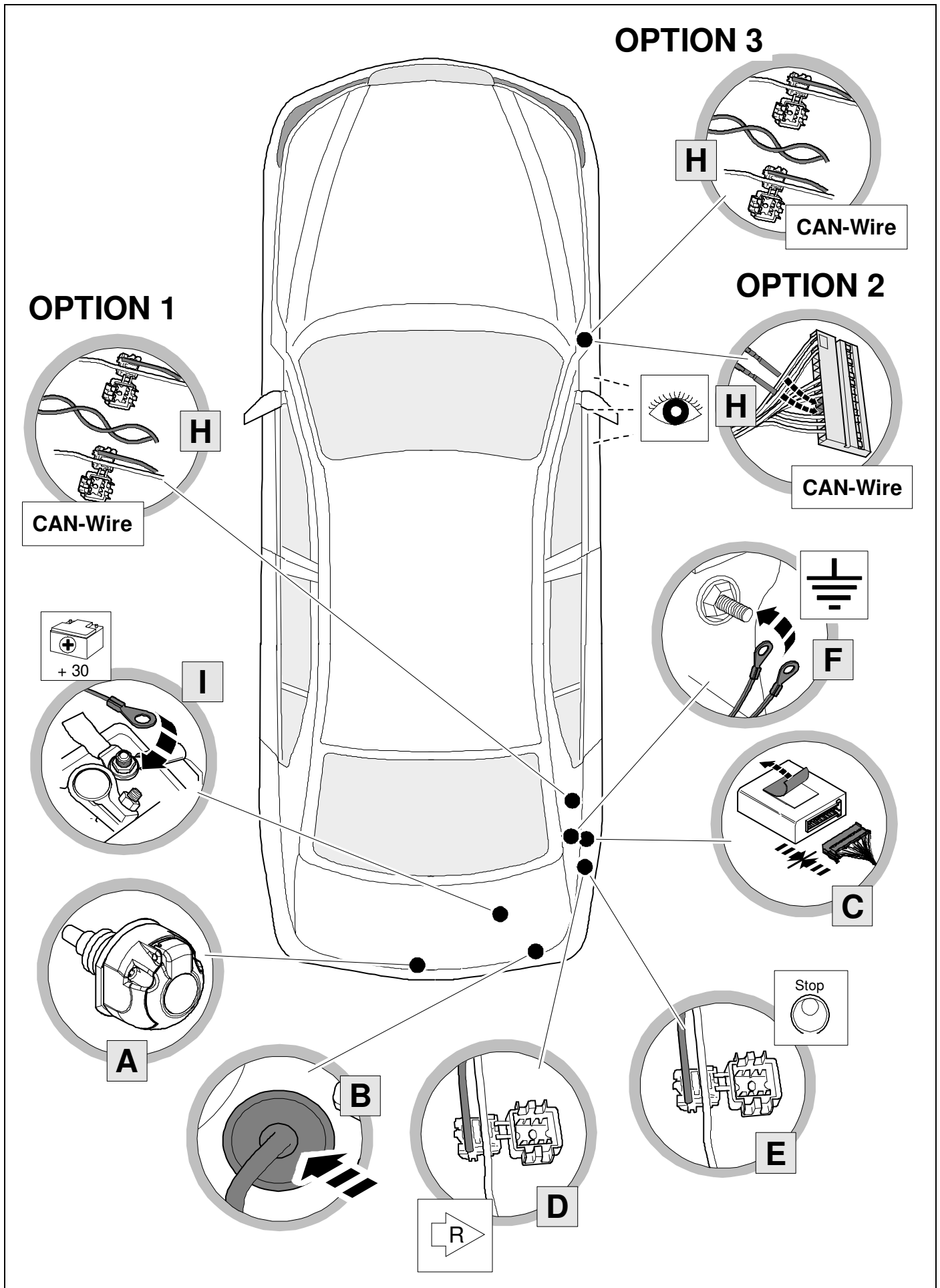

# KIT

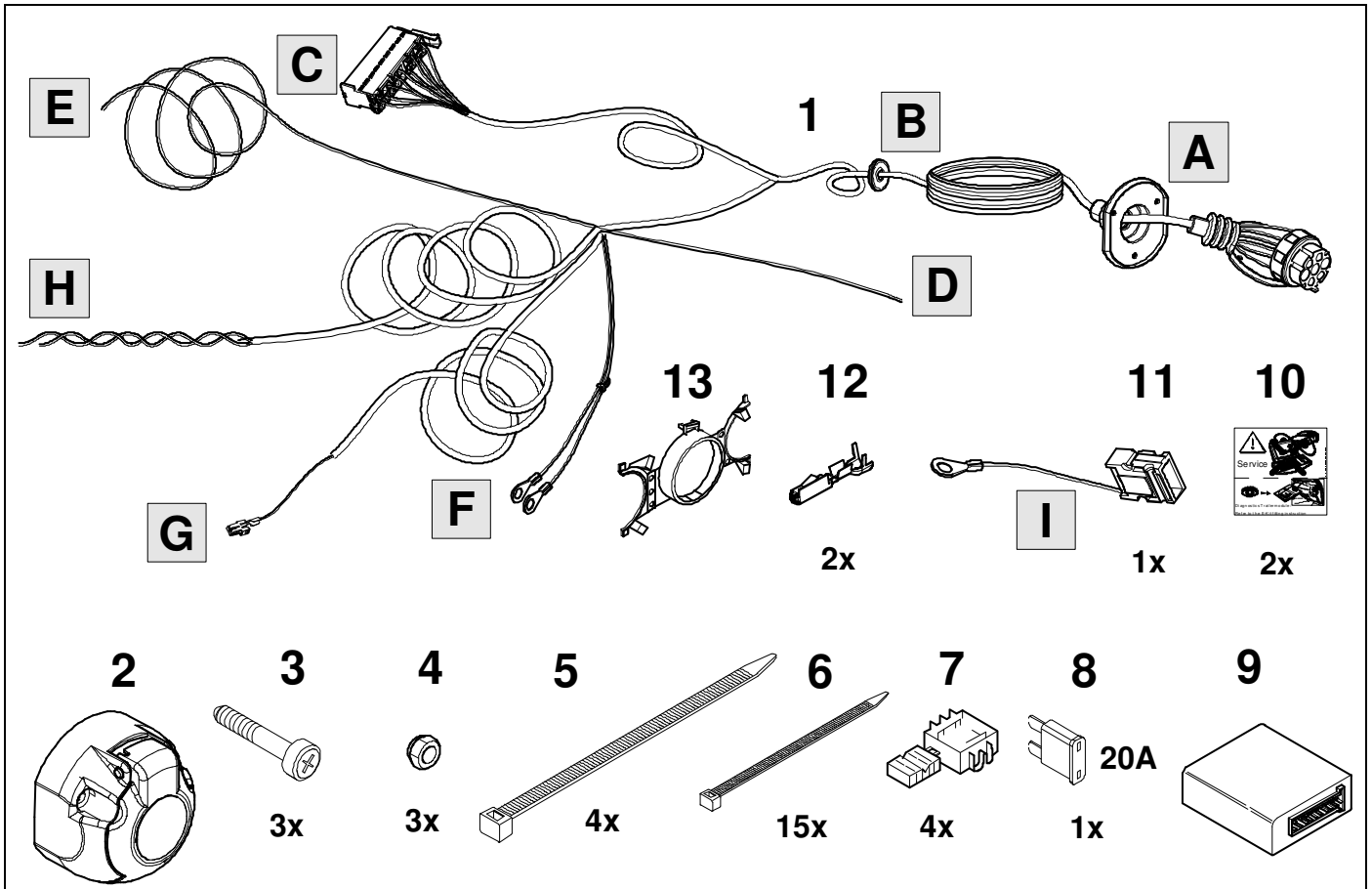

# TOOLS

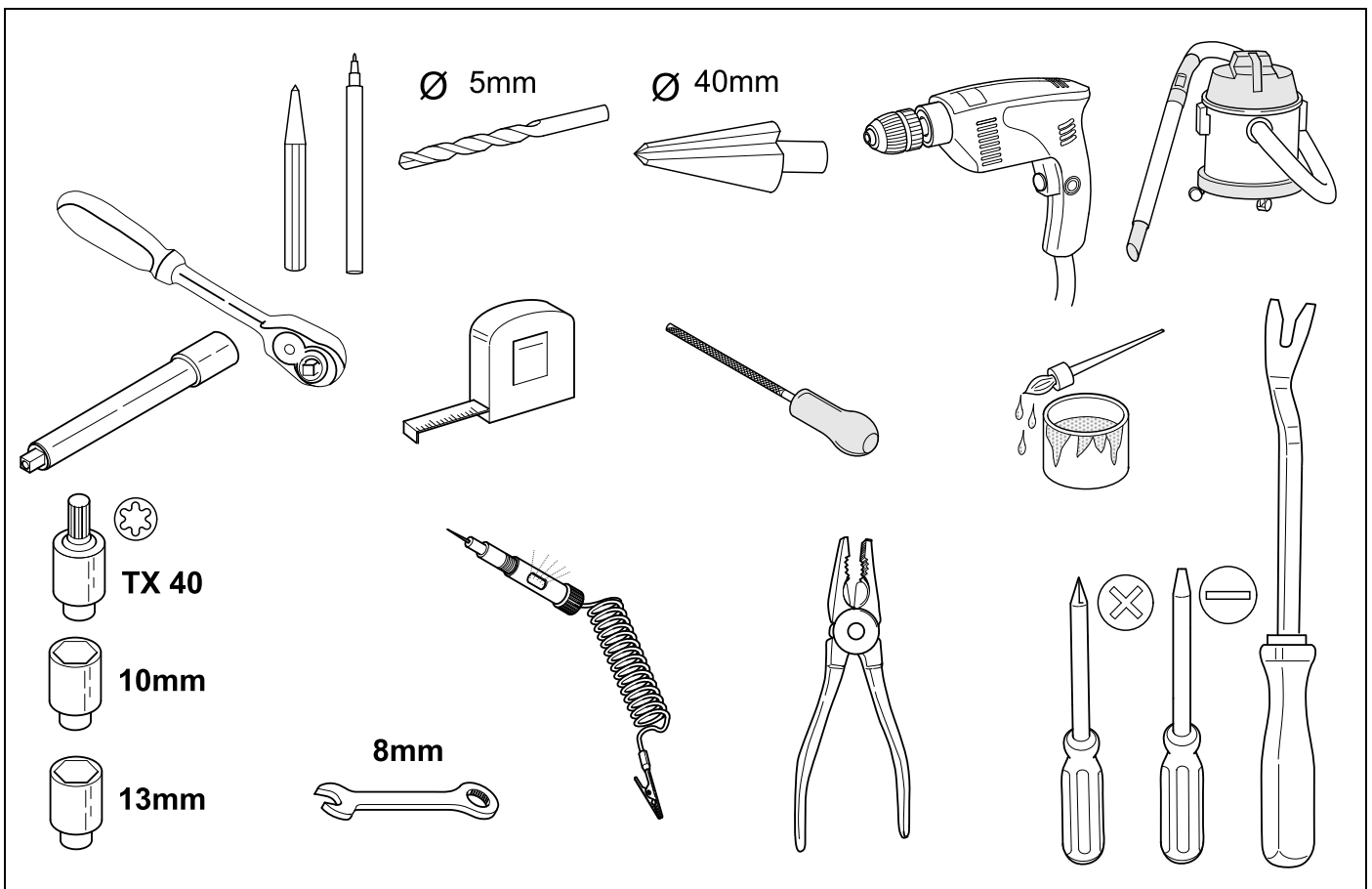

1

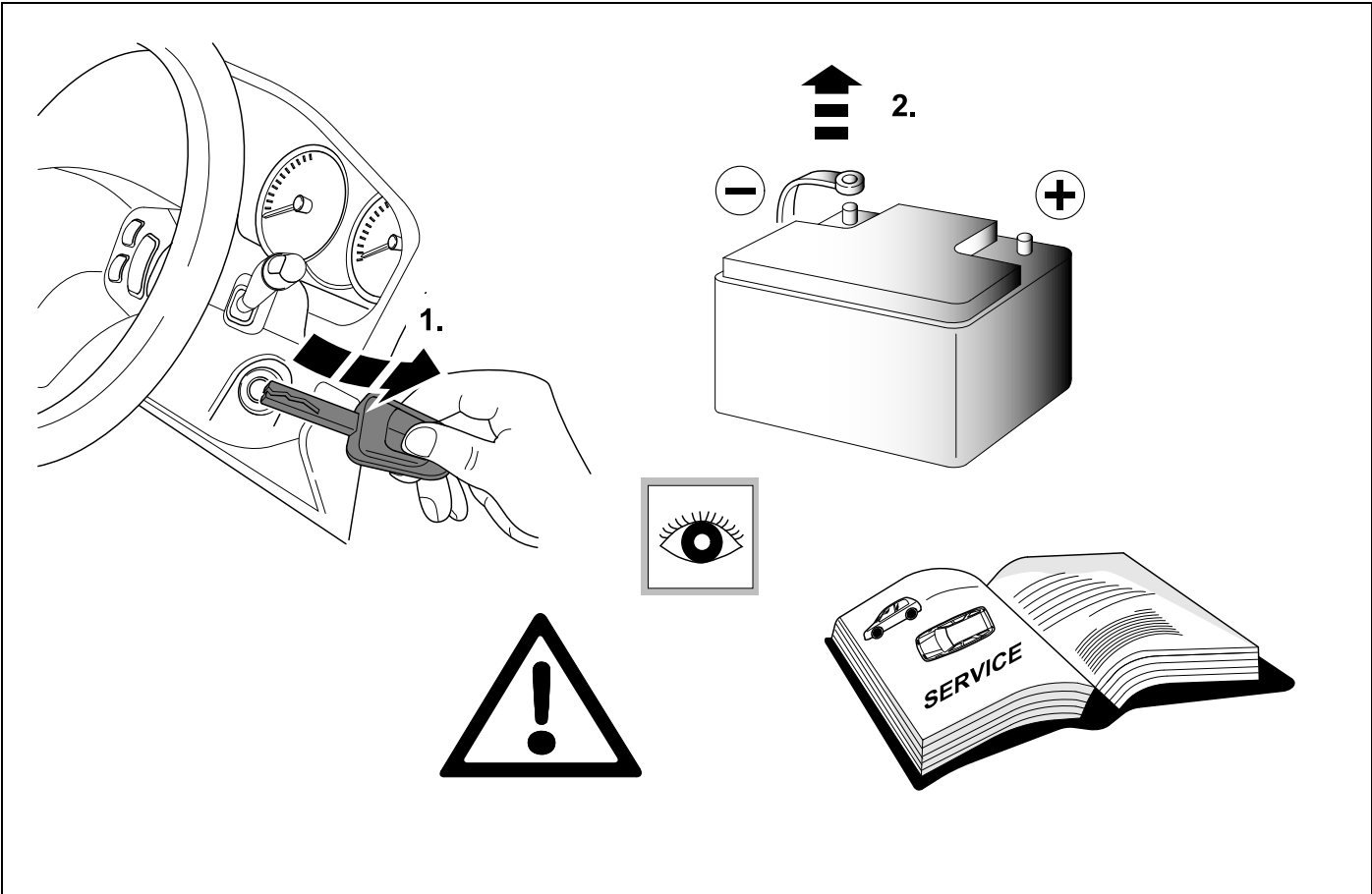

# 2 REMOVE

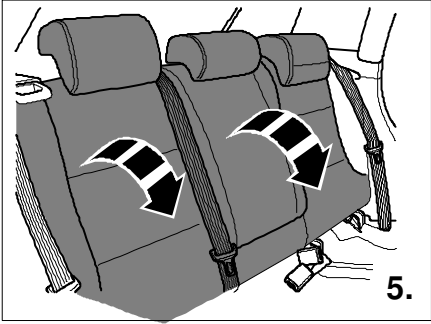

## OPTION 2 + OPTION 3

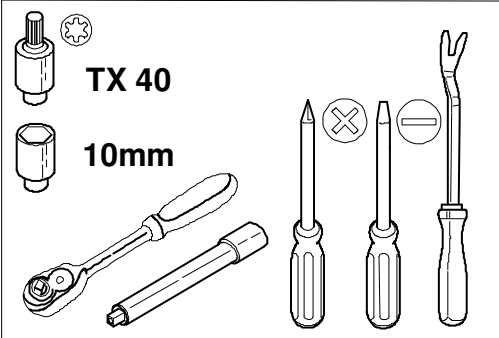
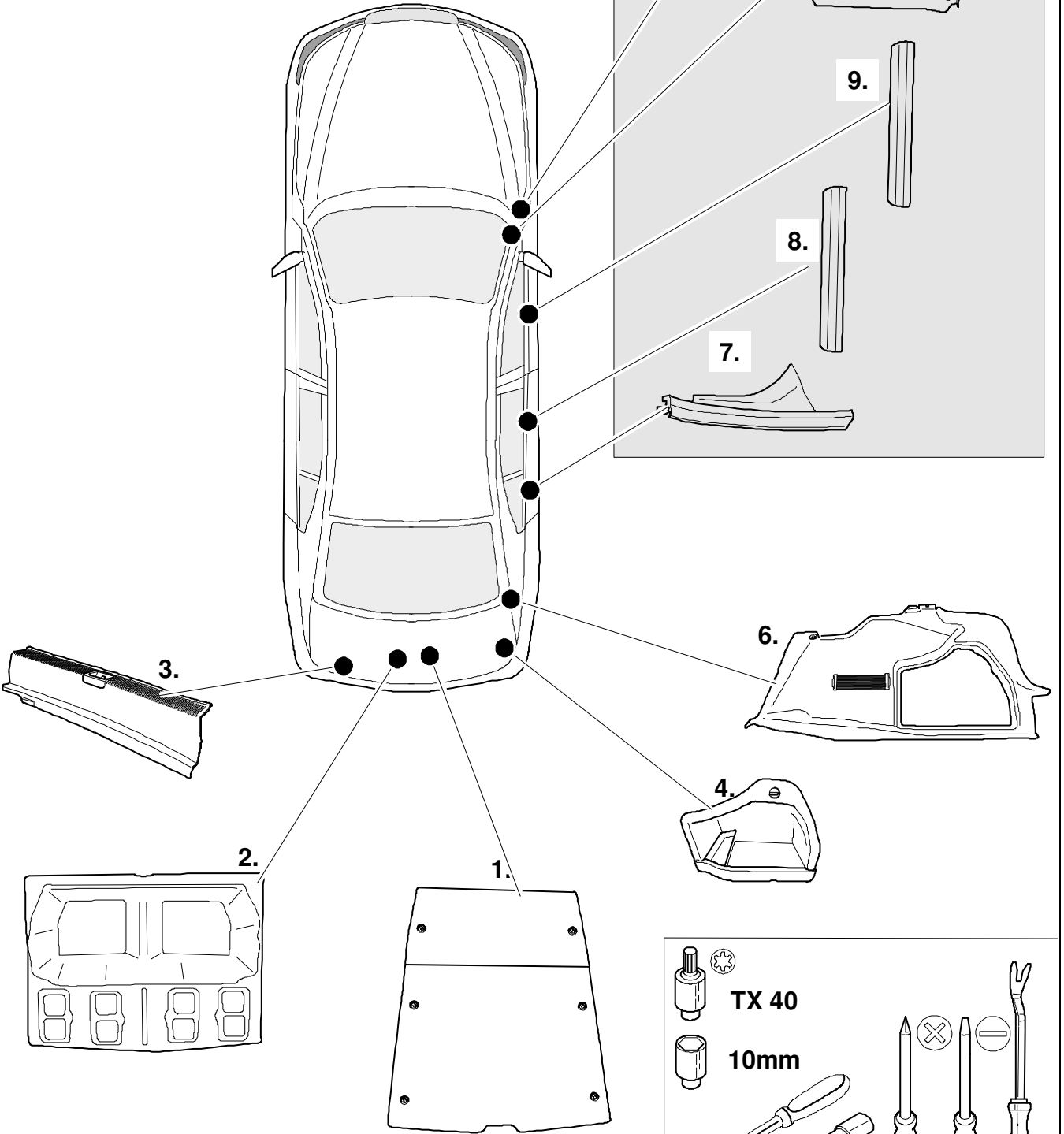
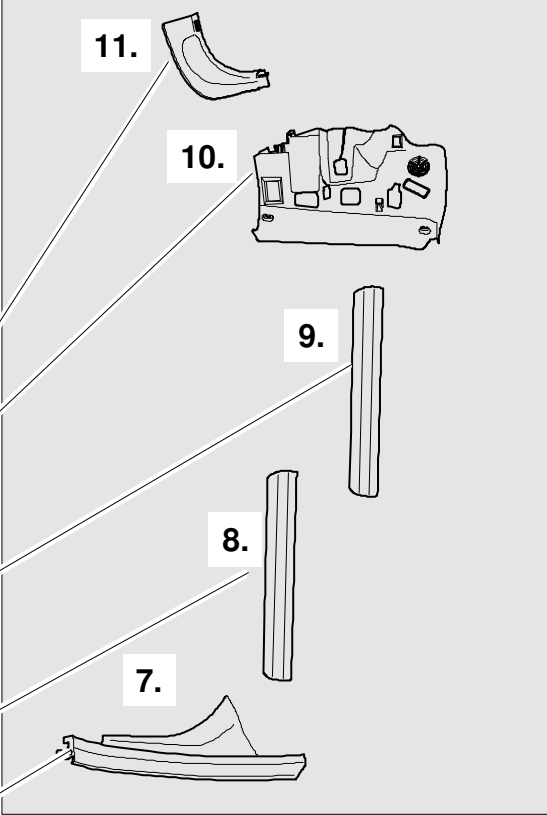

3

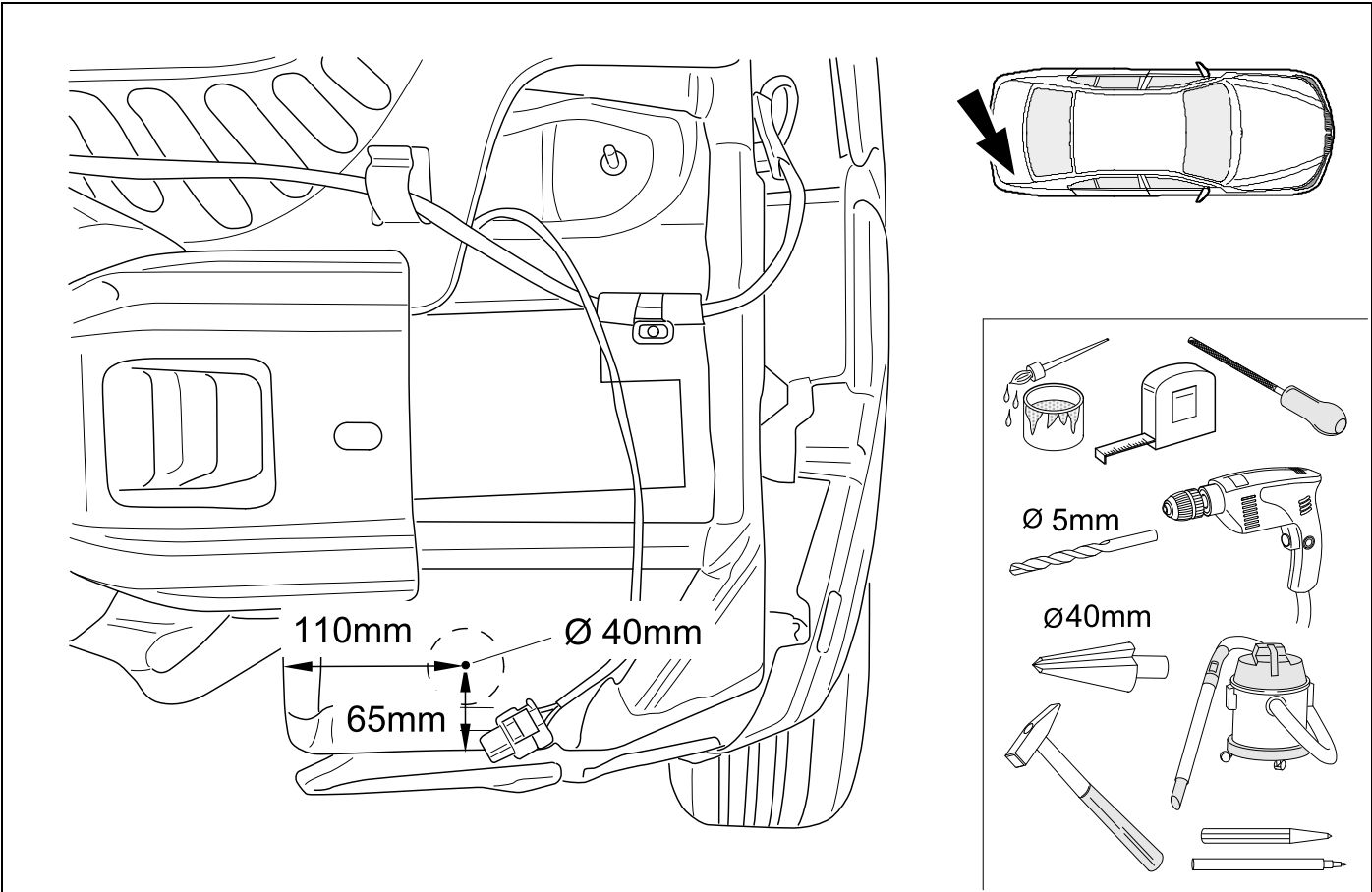

4

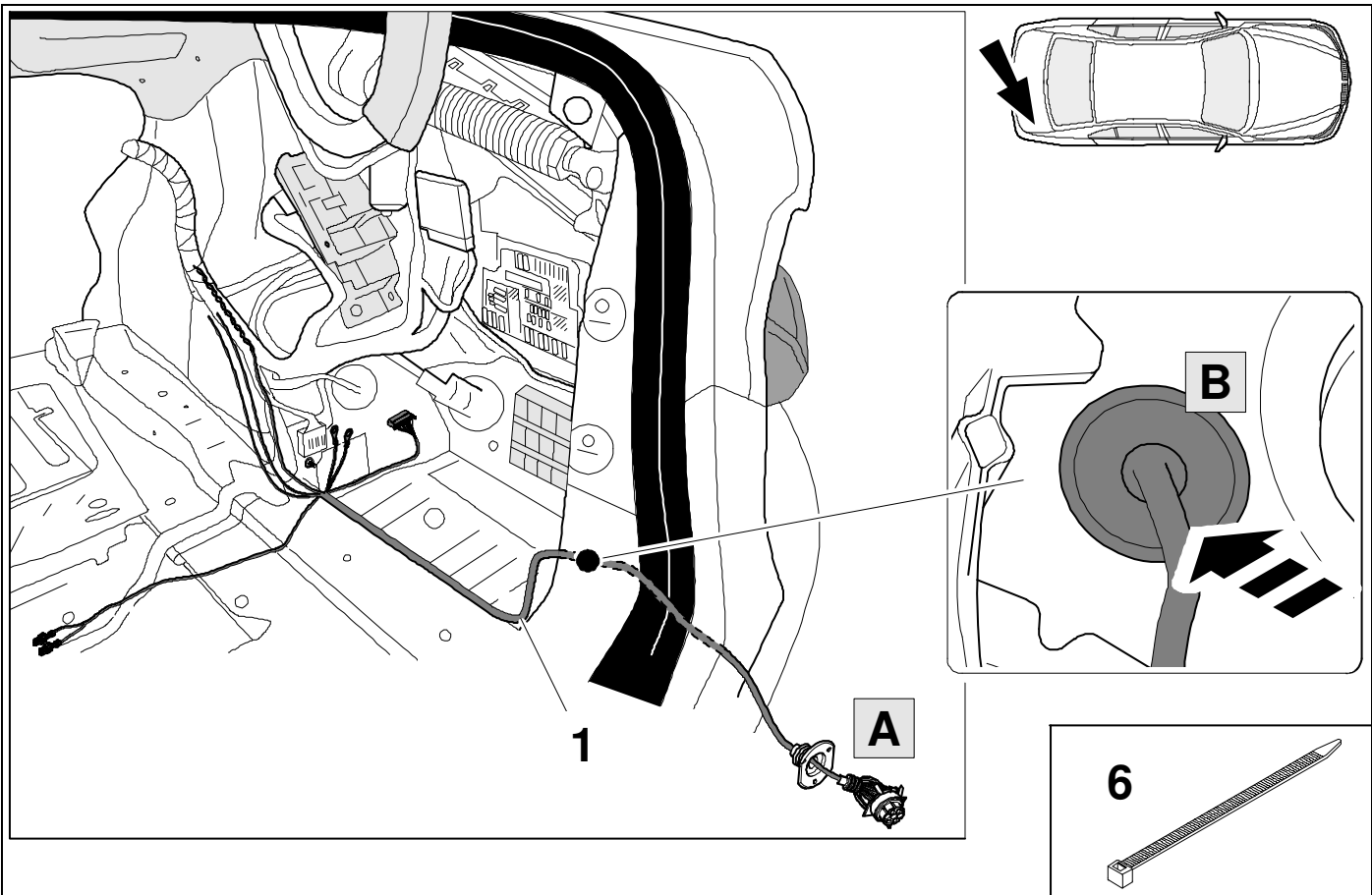

5

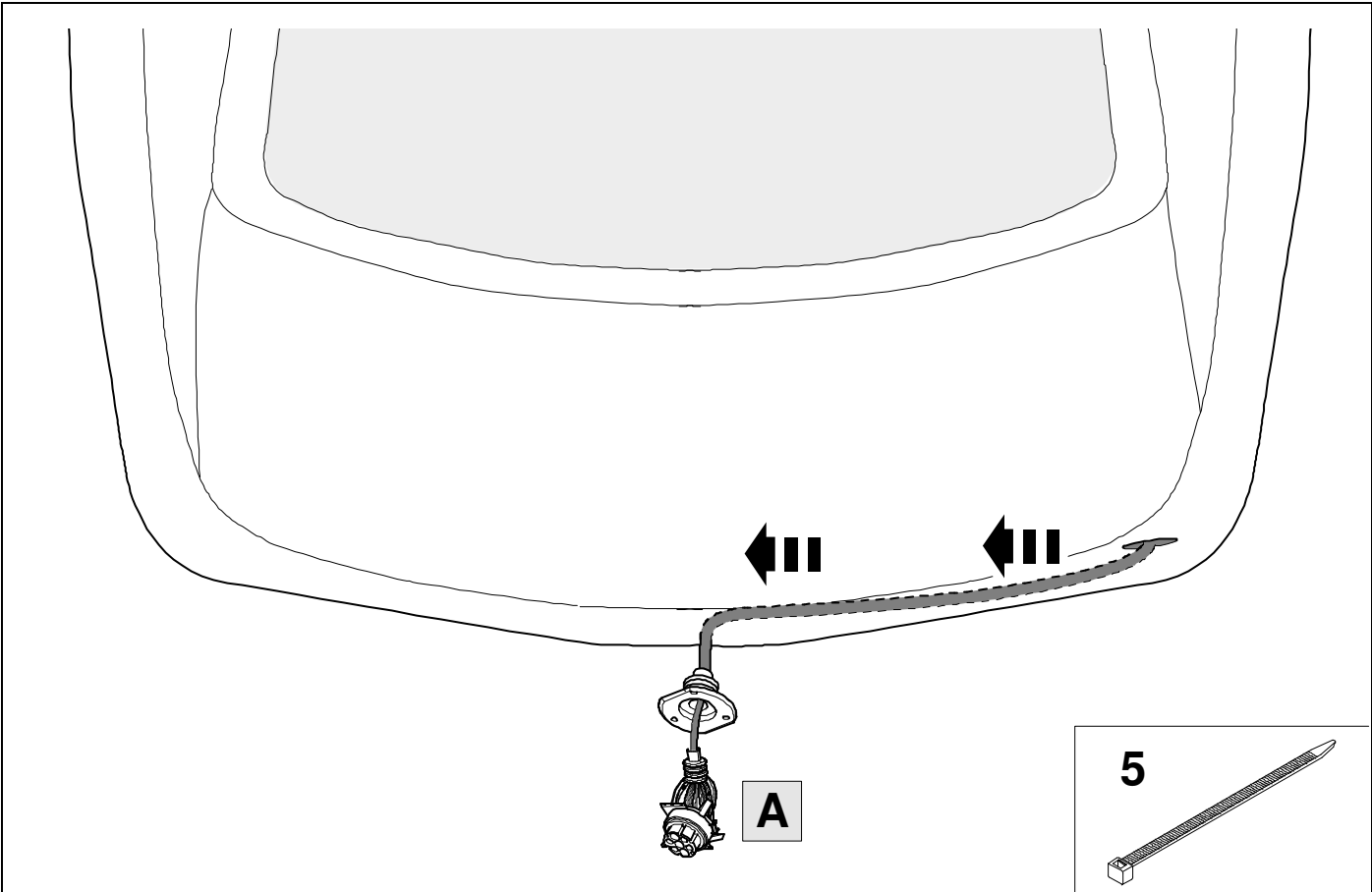

6

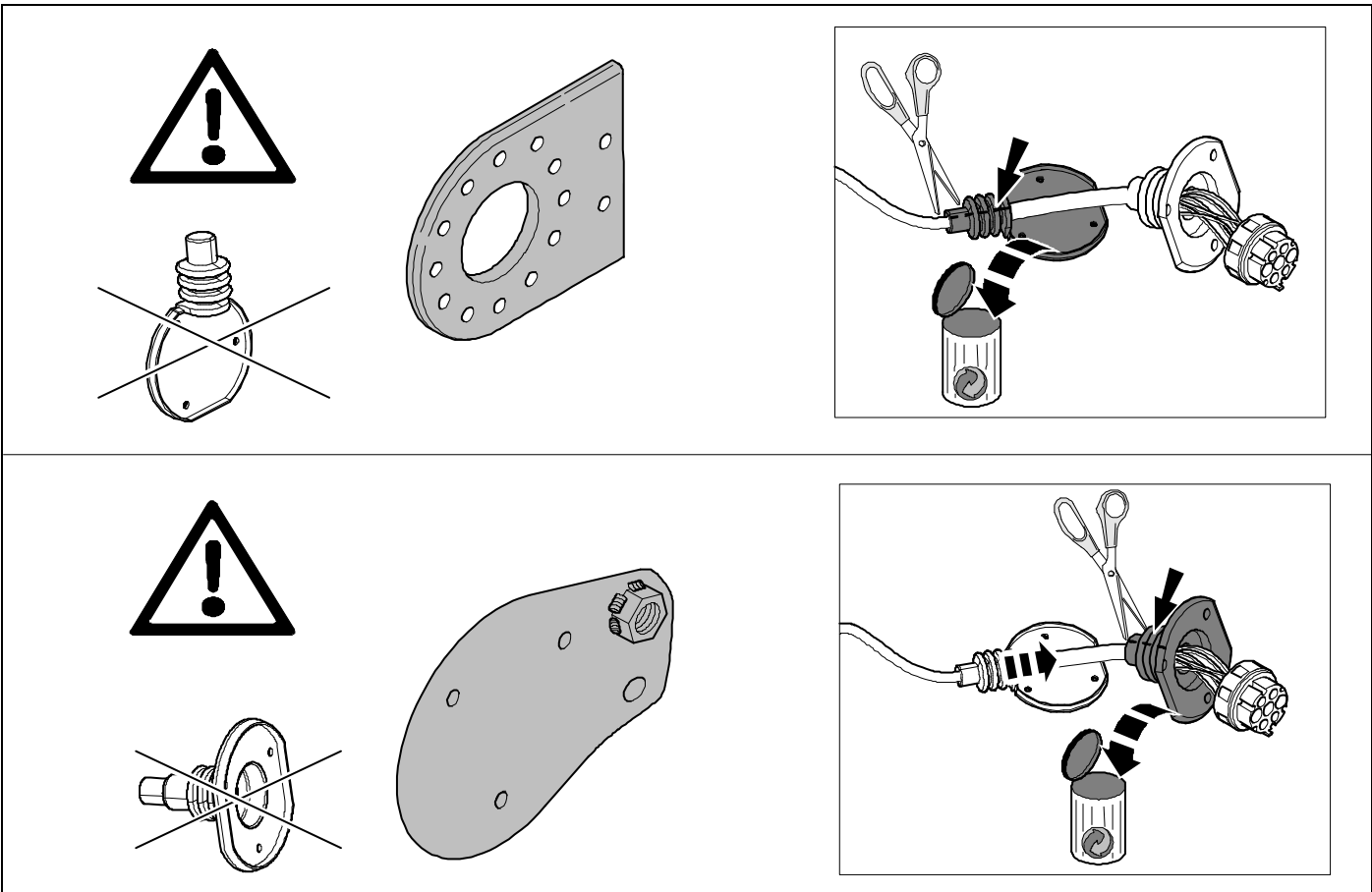

7



9

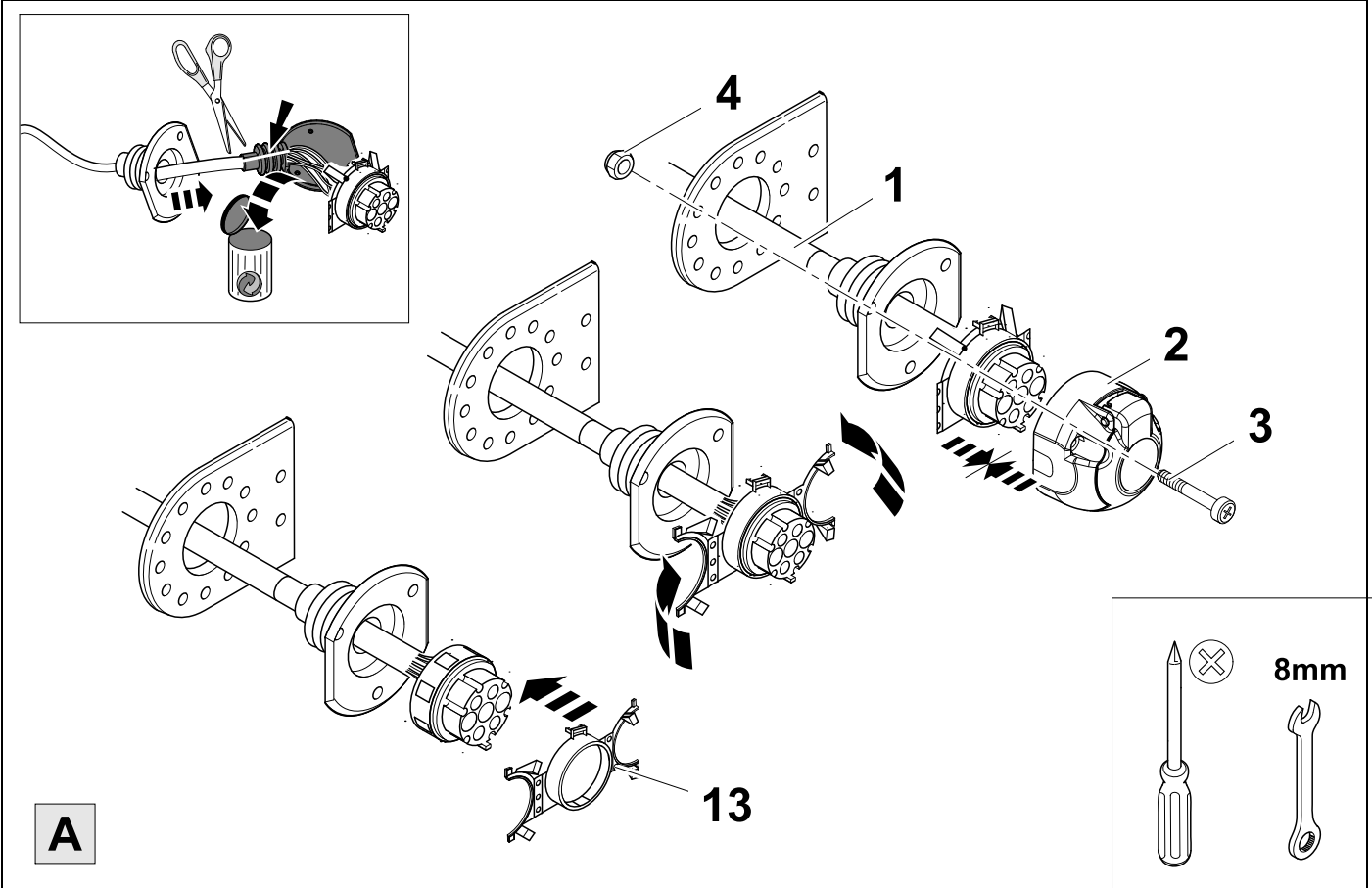

8



9

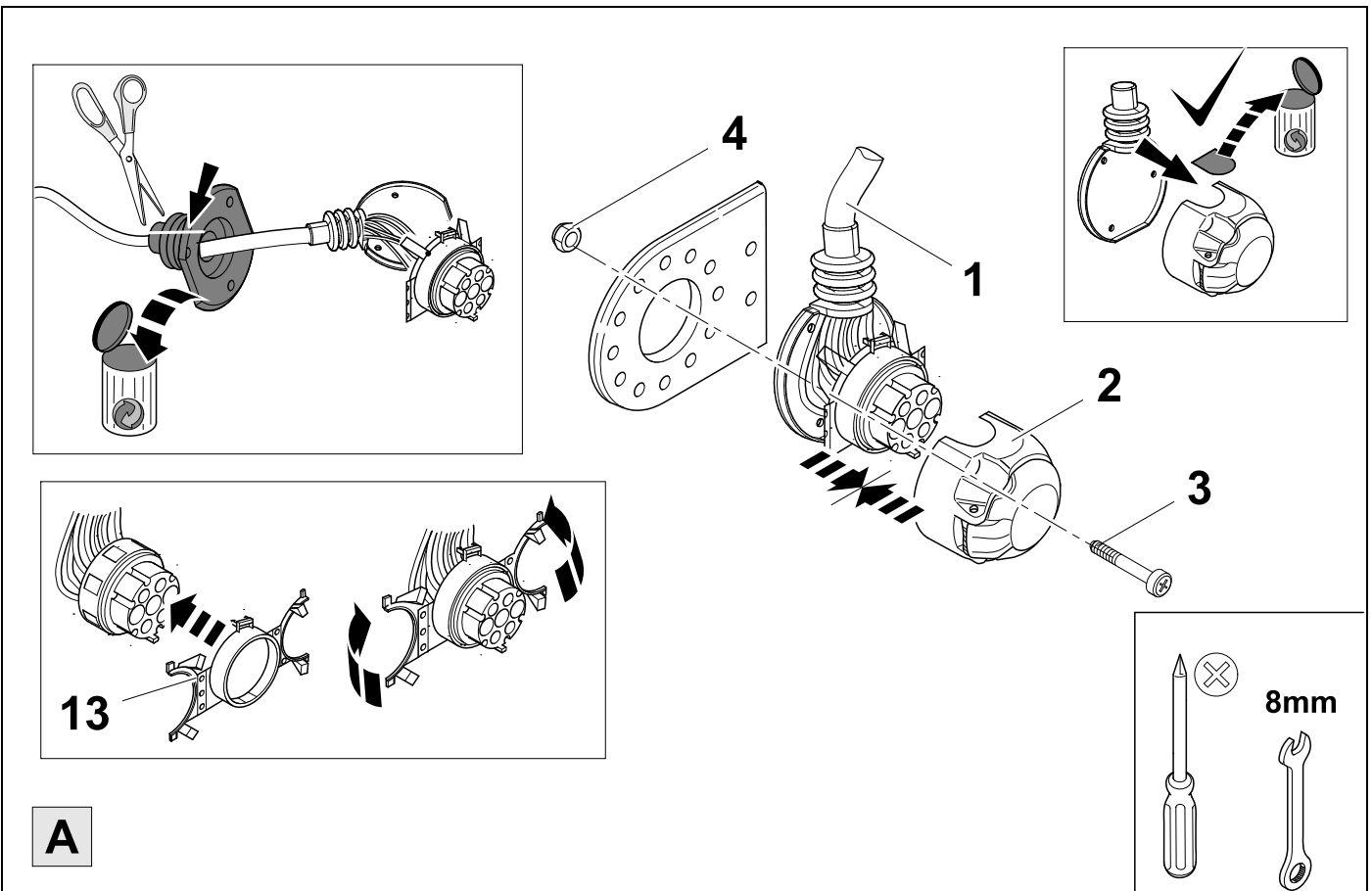





<b>1/L</b>	<b>bk/wh</b>	
<b>2/54g</b>	<b>gy</b>	
<b>3/31</b>	<b>wh/bn</b>	
<b>4/R</b>	<b>bk/gn</b>	
<b>5/58R</b>	<b>gy/rd</b>	
<b>6/54</b>	<b>bk/rd</b>	
<b>7/58L</b>	<b>gy/bk</b>	

10	bk	wh	gy	gn	rd	bu	ye	bn	pu	or	no
<b>(D)</b>	schwarz	weiß	grau	grün	rot	blau	gelb	braun	violett	orange	nicht belegt
<b>(GB)</b>	black	white	grey	green	red	blue	yellow	brown	purple	orange	not occupied
<b>(F)</b>	noir	blanc	gris	vert	rouge	bleu	jaune	brun	violet	orange	inutilisé
<b>(NL)</b>	zwart	wit	grijs	groen	rood	blauw	geel	bruin	violet	oranje	niet aangesloten
<b>(DK)</b>	sort	hvid	grå	grøn	rød	blå	gul	brun	violet	orange	ikke anvendt
<b>(N)</b>	svart	hvit	grå	grønn	rød	blå	gul	brun	fiolett	oransje	ikke i bruk
<b>(S)</b>	svart	vit	grå	grön	röd	blå	gul	brun	violett	orange	ej använd
<b>(FIN)</b>	musta	valkoinen	harmaa	vihreä	punainen	sininen	keltainen	ruskea	violetti	oranssi	ei varattu
<b>(I)</b>	nero	bianco	grigio	verde	rosso	blu	giallo	marrone	viola	arancione	libero
<b>(E)</b>	negro	blanco	gris	verde	rojo	azul	amarillo	marrón	violeta	anaranja-do	no ocupado
<b>(P)</b>	preto	branco	cinzento	verde	vermelho	azul	amarelo	castanho	violeta	laranja	não ocupado
<b>(GR)</b>	μαύρος	λευκός	Γκρι	πράσινος	κόκκινος	μπλε	κίτρινος	καφέ	Μωβ	πορτοκαλί	δεν είναι κατ'επιλημμένος
<b>(PL)</b>	czarny	biały	szary	zielony	czerwony	niebiesko	żółty	brazowy	fioletowy	pomarańczowy	wolny
<b>(CZ)</b>	černý	bílý	šedý	zelený	červený	modrý	žlutý	hnědý	fialový	oranžový	neobsazen
<b>(TR)</b>	siyah	beyaz	gri	yeşil	kırmızı	mavi	sarı	kahverengi	mor	portakal rengi	boş
<b>(H)</b>	fekete	fehér	szürke	zöld	piros	kék	sárga	barna	ibolyakék	narancssárga	nem foglalt
<b>(HR)</b>	crno	bijelo	sivo	zeleno	crveno	plavo	zuto	smeđe	ljubičasto	narandasto	nije zauzeto
<b>(BUL)</b>	черен	бял	сив	зелен	червен	син	жълт	кафяв	виолетов	оранжев	свободно
<b>(RO)</b>	negru	alb	gri	verde	roșu	albastru	galben	maro	violet	portocaliu	liber
<b>(RU)</b>	черный	белый	серый	зеленый	красный	голубой	жёлтый	коричневый	пурпурный	оранжевый	свободно
<b>(LT)</b>	juoda	balta	pilka	žalia	raudona	mėlyna	geltona	ruda	purpurinė	oranžinė	laisva
<b>(LV)</b>	melna	balta	pelēka	zaļa	sarkana	zila	dzeltena	brūna	purpur-sarkana	oranža	brīvs
<b>(EST)</b>	must	valge	hall	roheline	punane	sinine	kollane	pruun	purpur-punane	oraanž	vaba
<b>(SLO)</b>	črna	bela	siva	zelena	rdeča	modra	rumena	smeđ	vijoličast	oranžen	ni zasedeno
<b>(SK)</b>	čierny	biely	šedý	zelený	červený	modrý	žltý	hnědý	fialový	pomaraňový	neobsadený

11

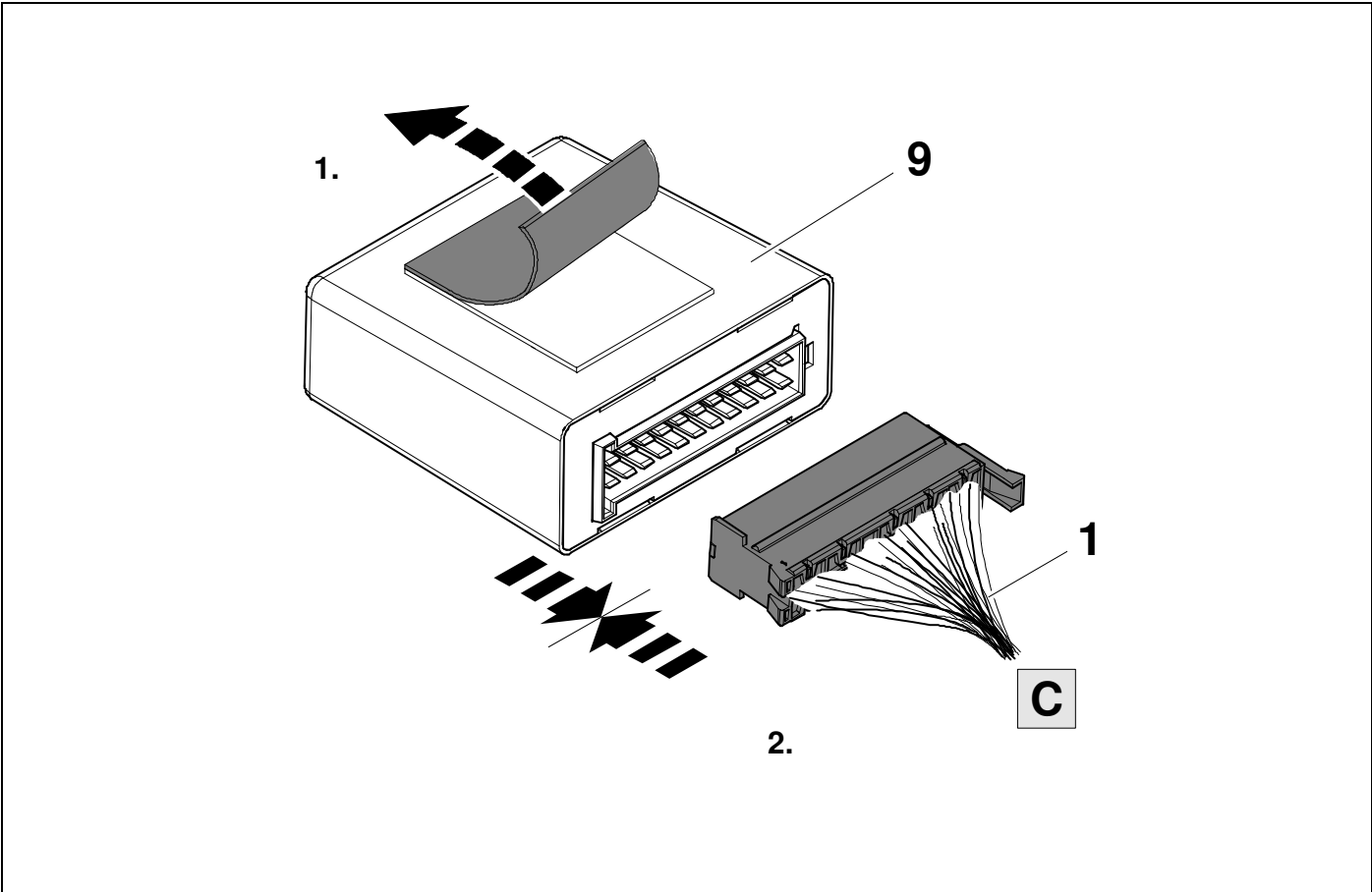

12

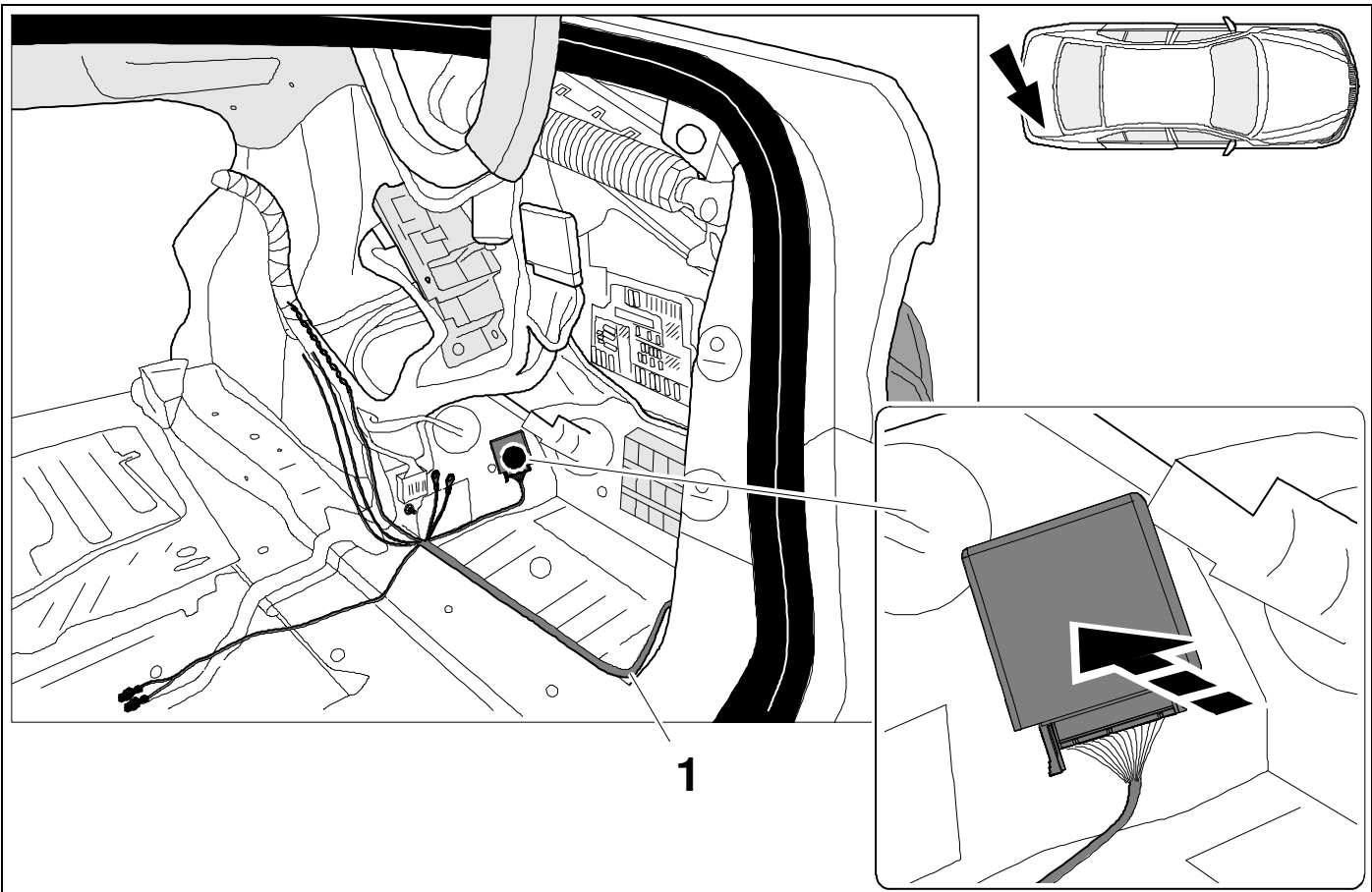

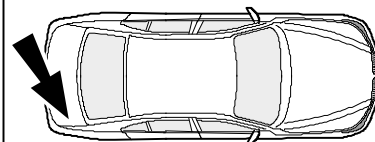
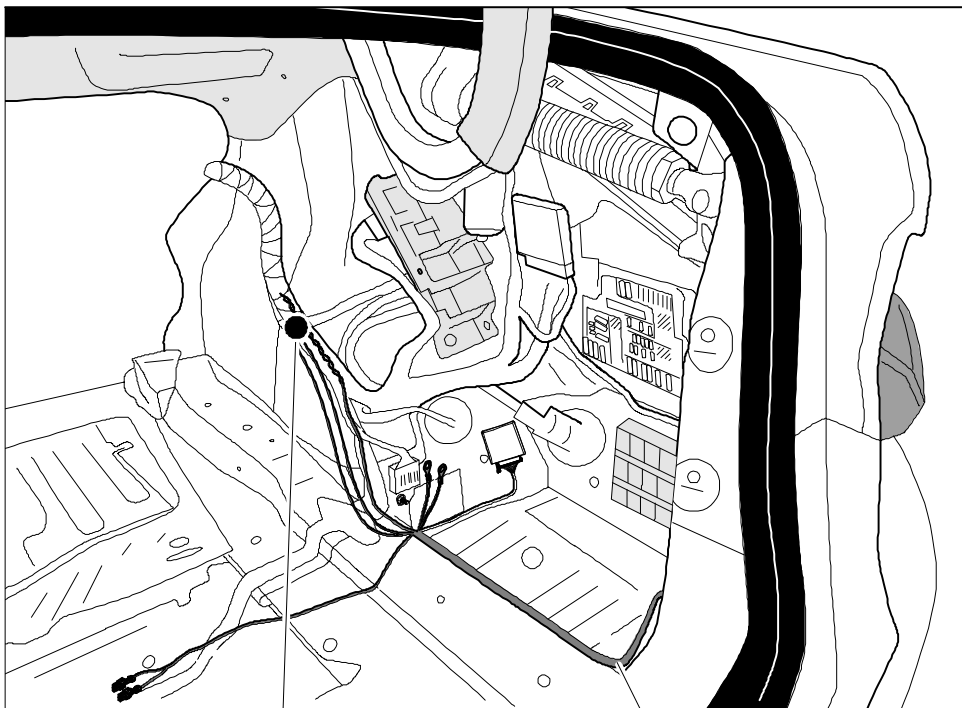

1

1.

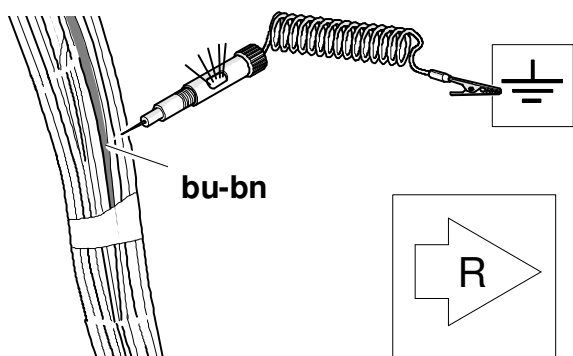

2.

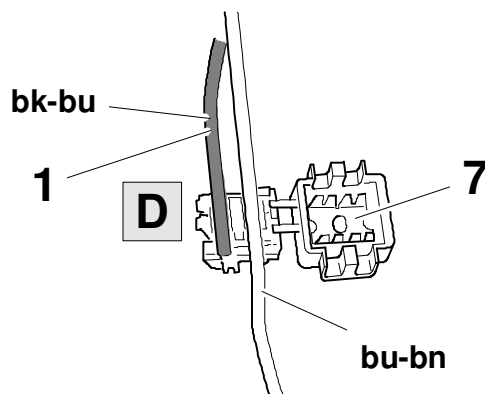

3.

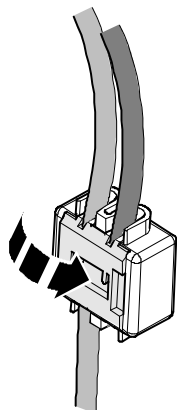

4.

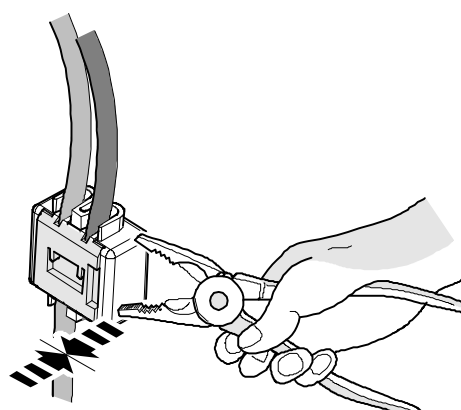

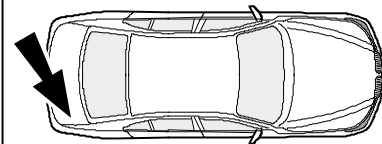
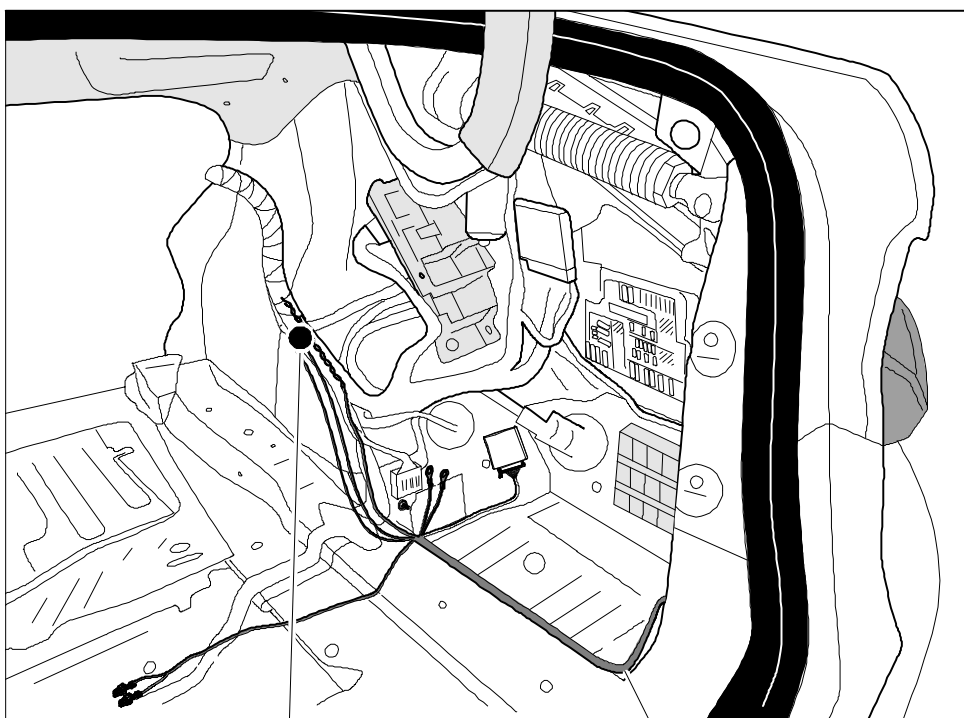

1

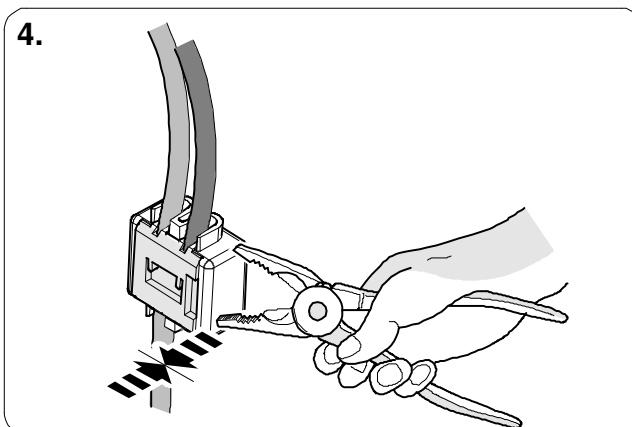
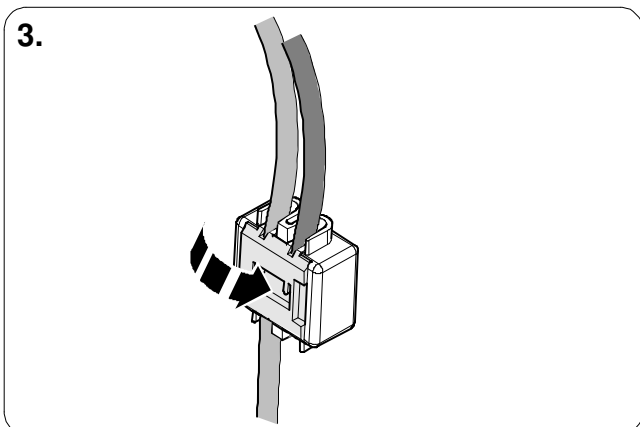
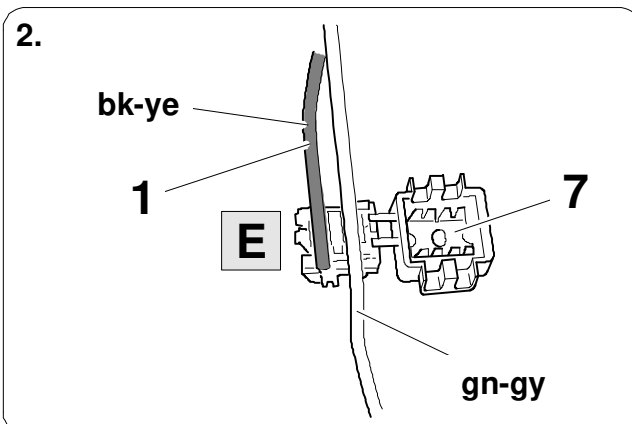
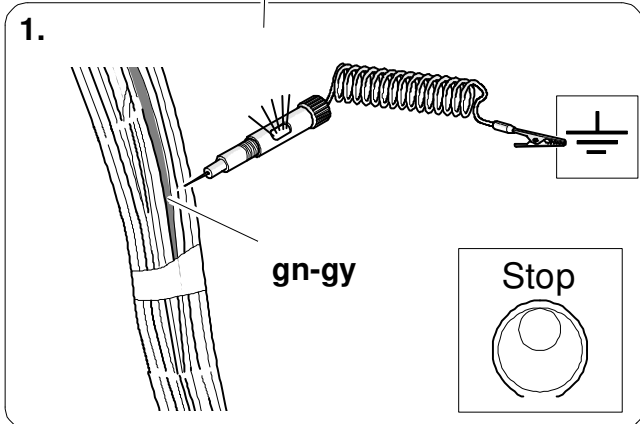

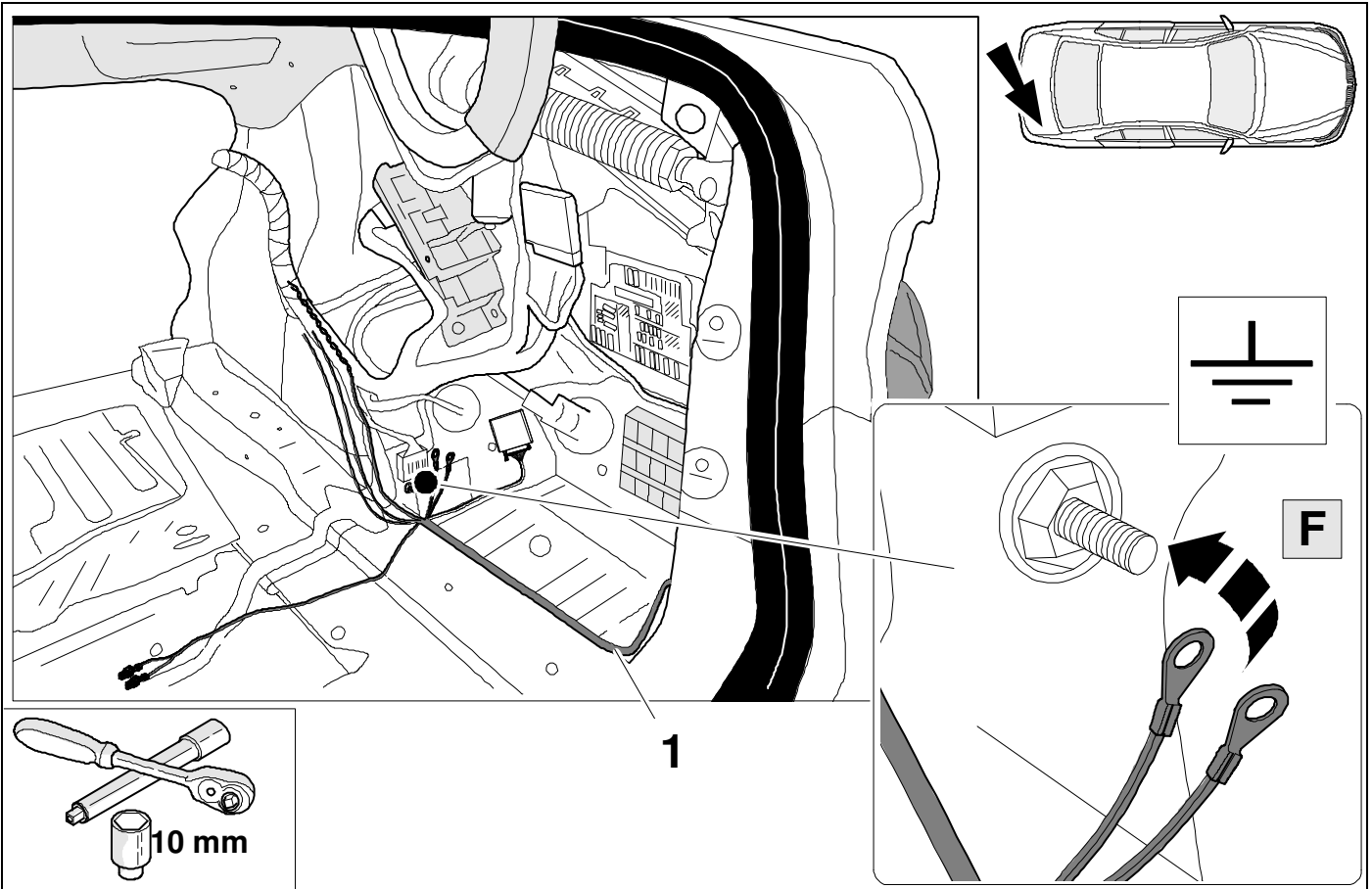

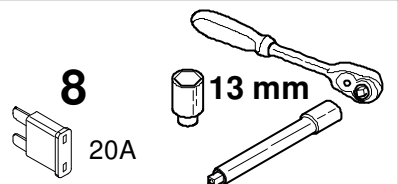
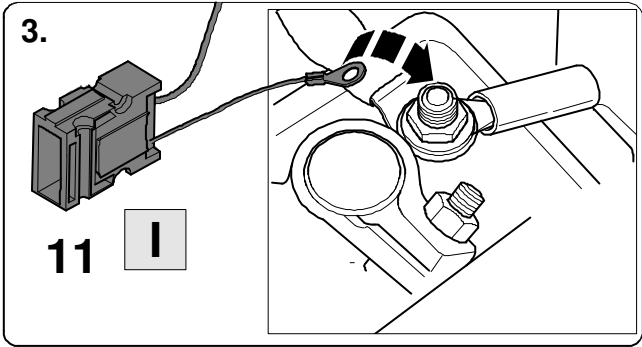
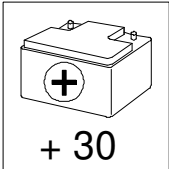
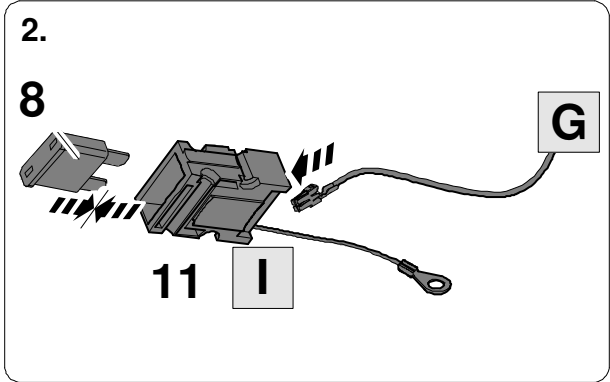
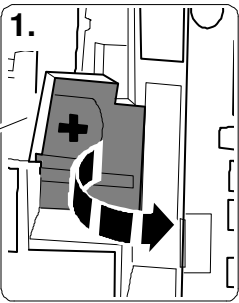
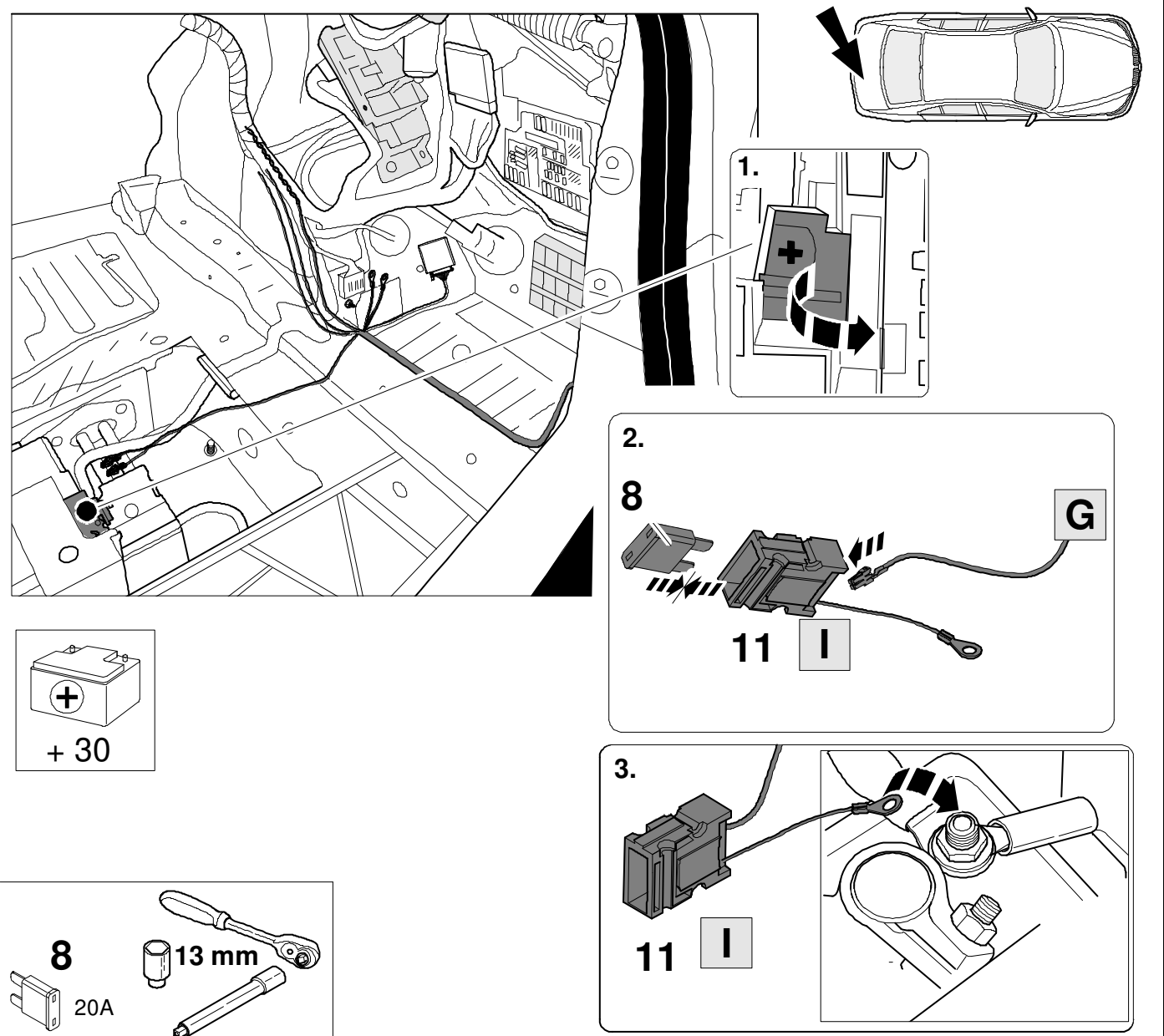

**OPTION 1**

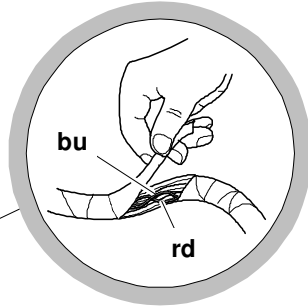

$$\begin{array}{r} \boxed{18} \\ + \\ \boxed{24} - \boxed{34} \end{array}$$

**OPTION 2**

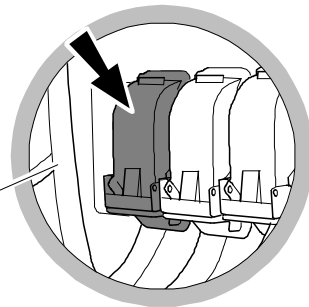

$$\begin{array}{r} \boxed{19} - \boxed{21} \\ + \\ \boxed{24} - \boxed{34} \end{array}$$

**OPTION 3**

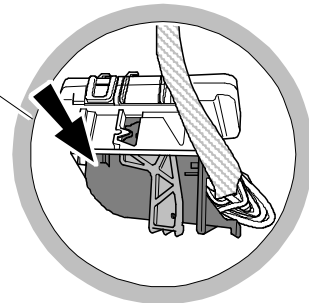

$$\boxed{22} - \boxed{34}$$

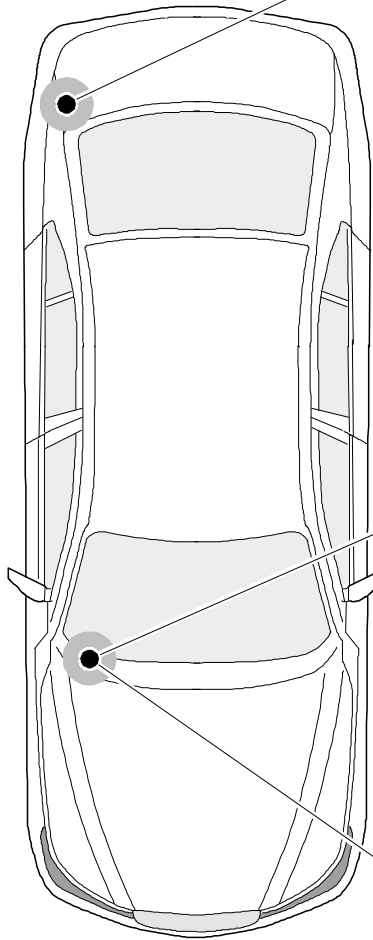

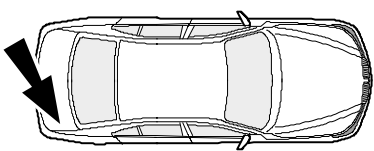
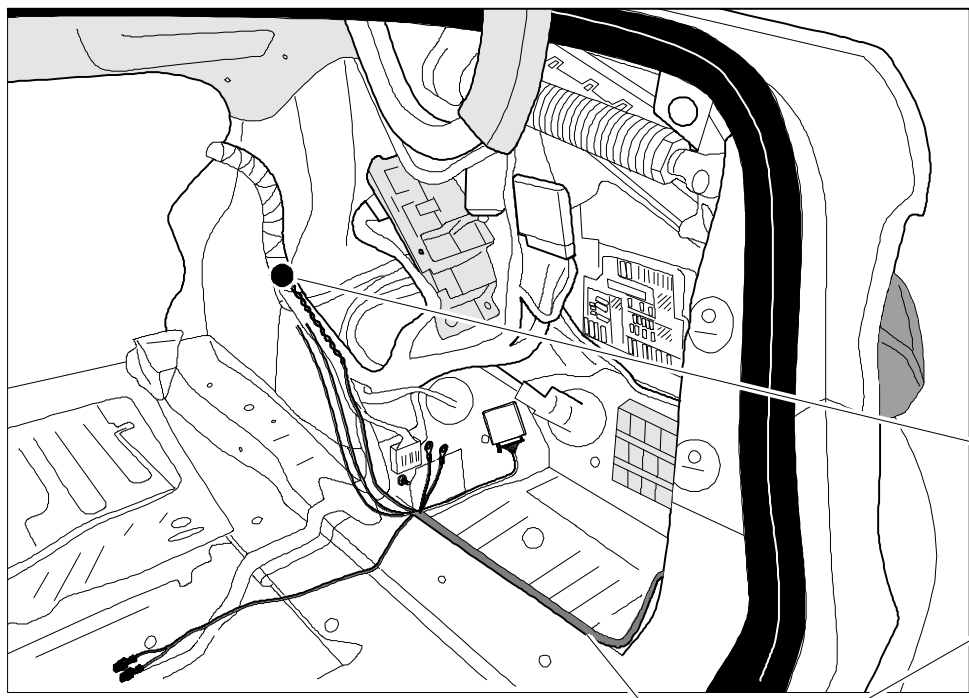

CAN-Wire

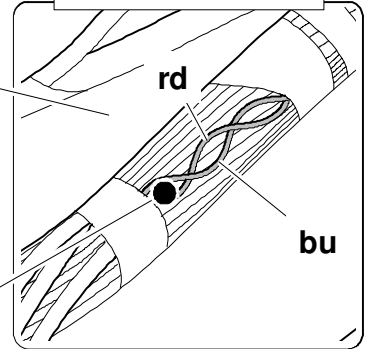

1

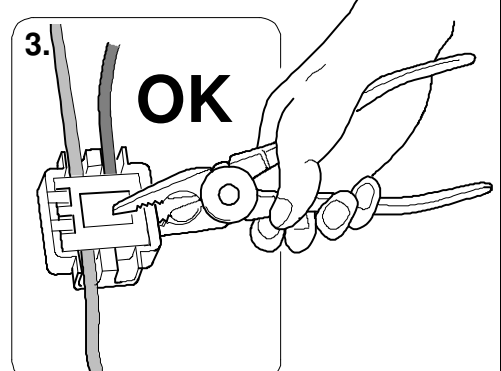
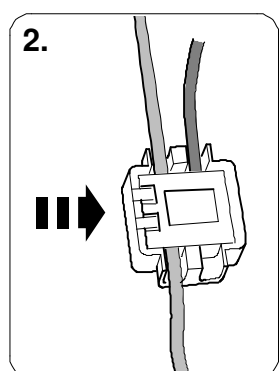
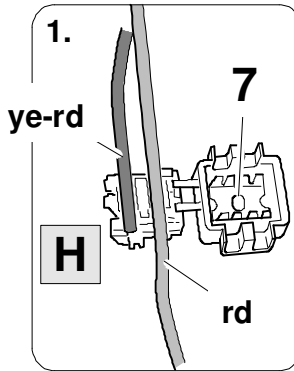
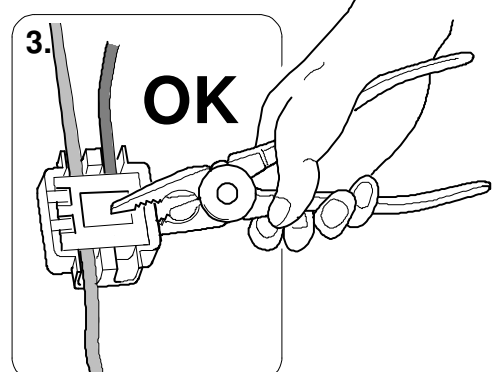
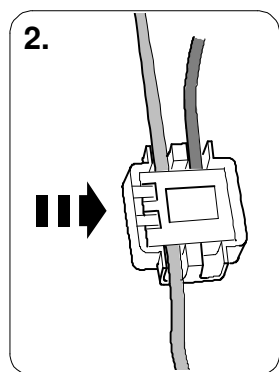
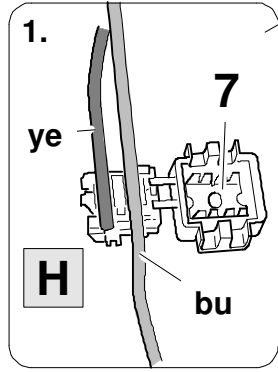



19

OPTION 2



10

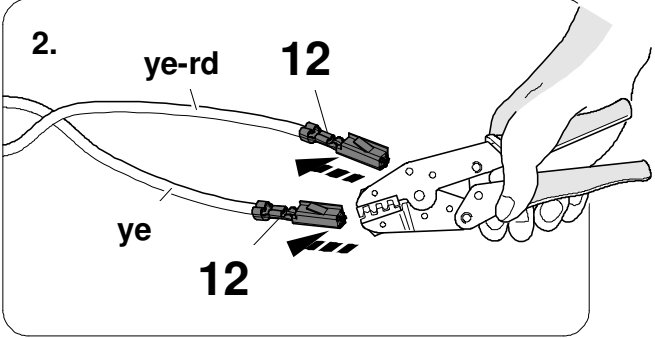
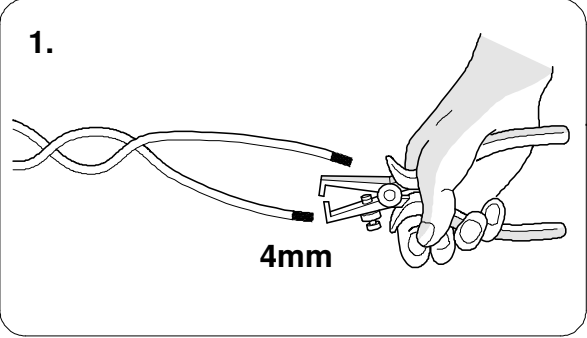
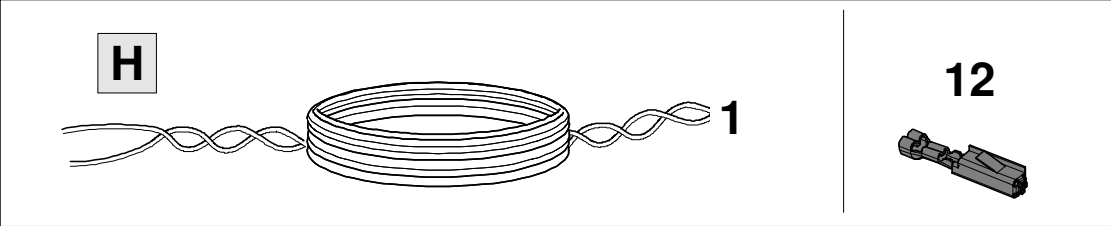

20

OPTION 2



10

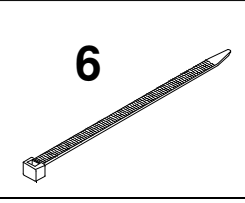
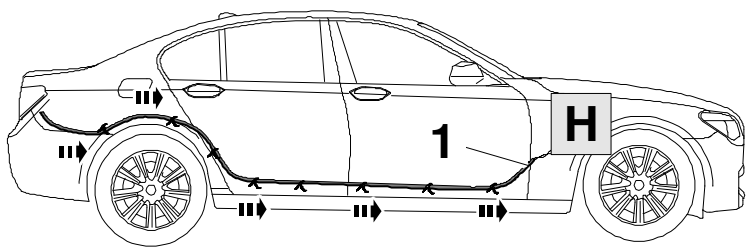
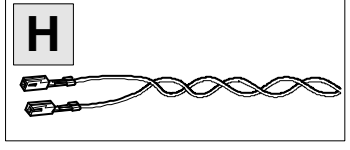
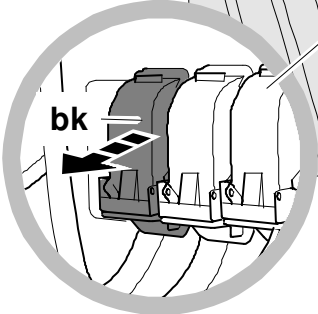
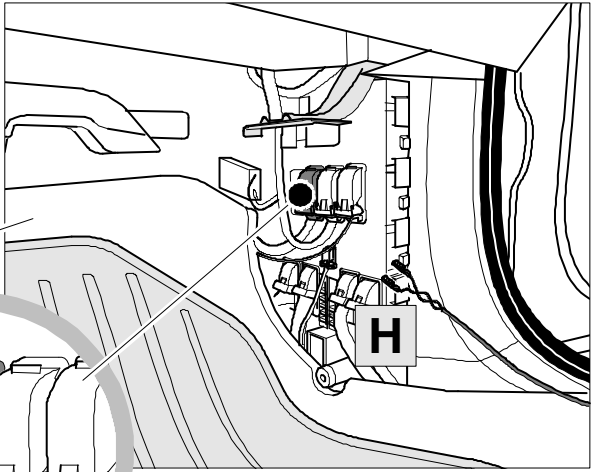
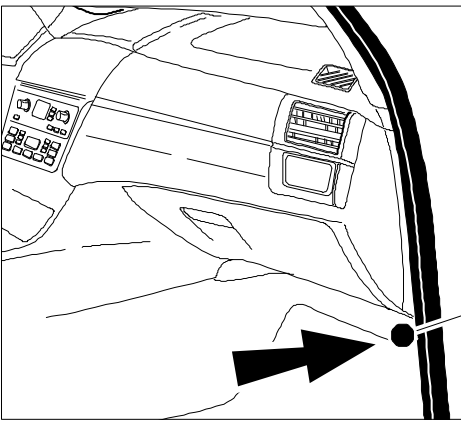

21

# OPTION 2



10

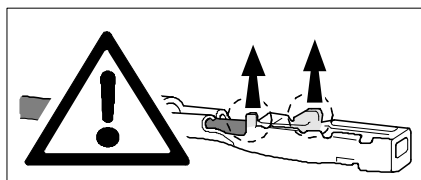
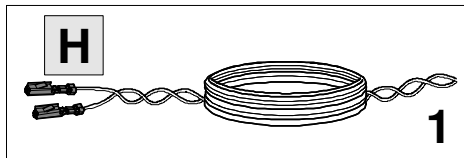
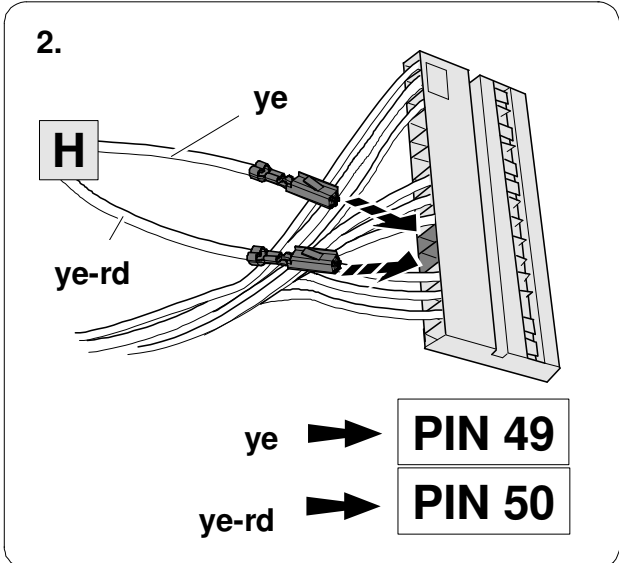
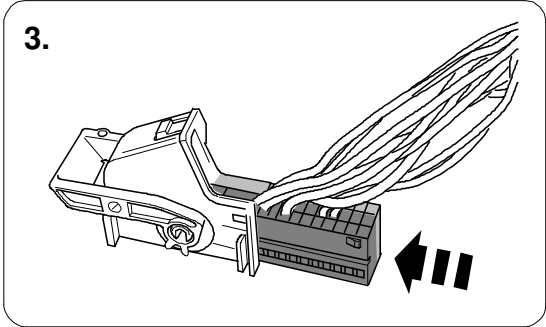
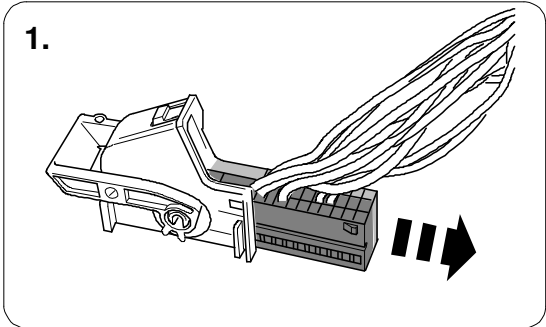

22

# OPTION 3



10

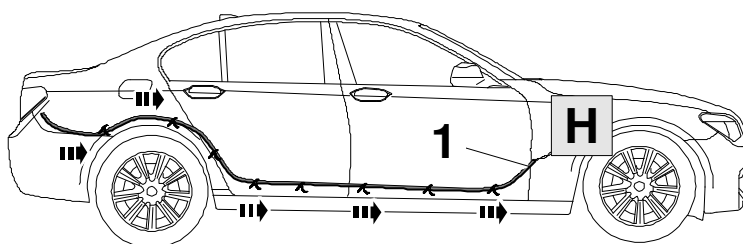
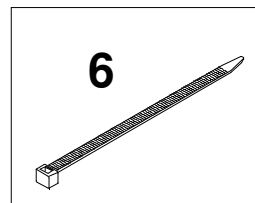
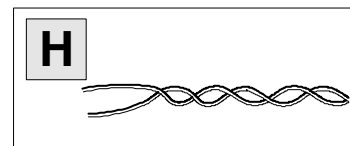
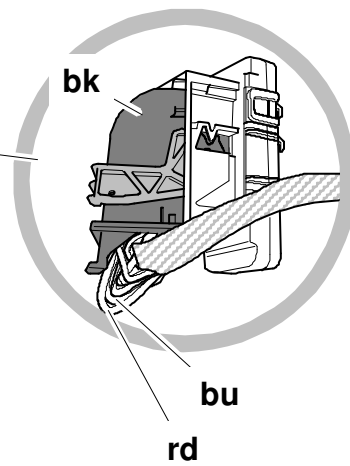
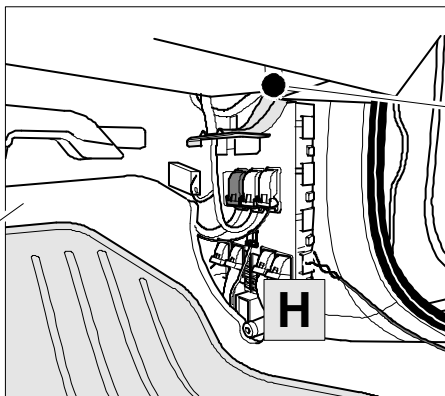
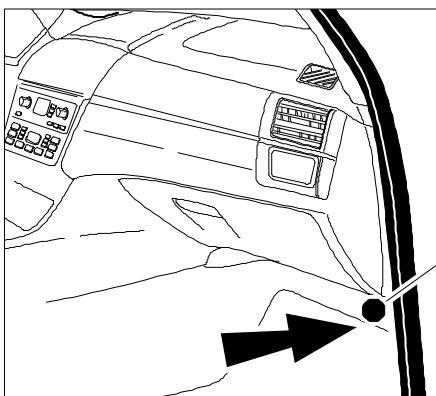

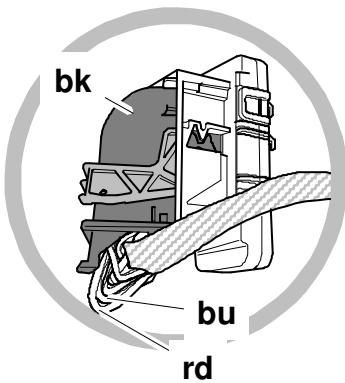

CAN Wire

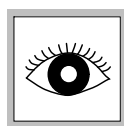
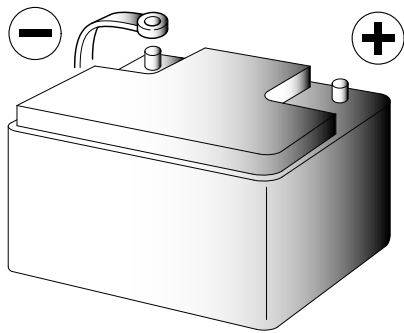
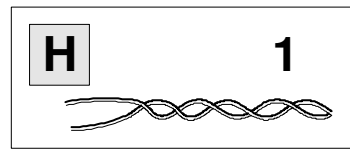
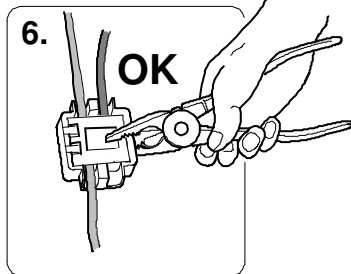
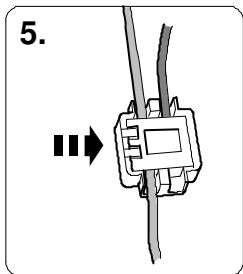
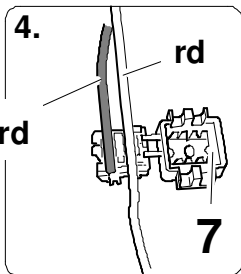
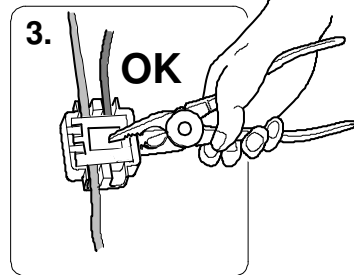
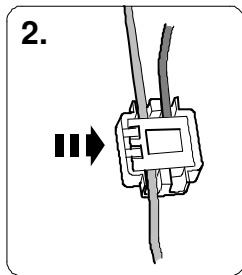
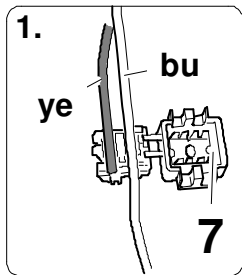

**25 CODING**

# BMW Service ISTA/P Initialize Trailer Module

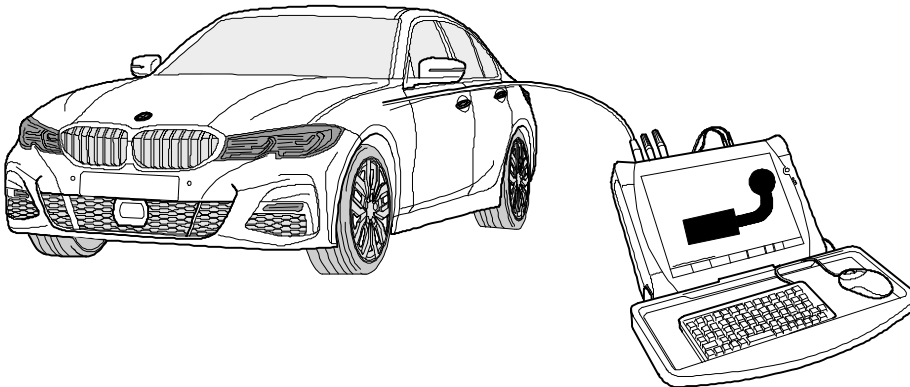

**26 CHECK**

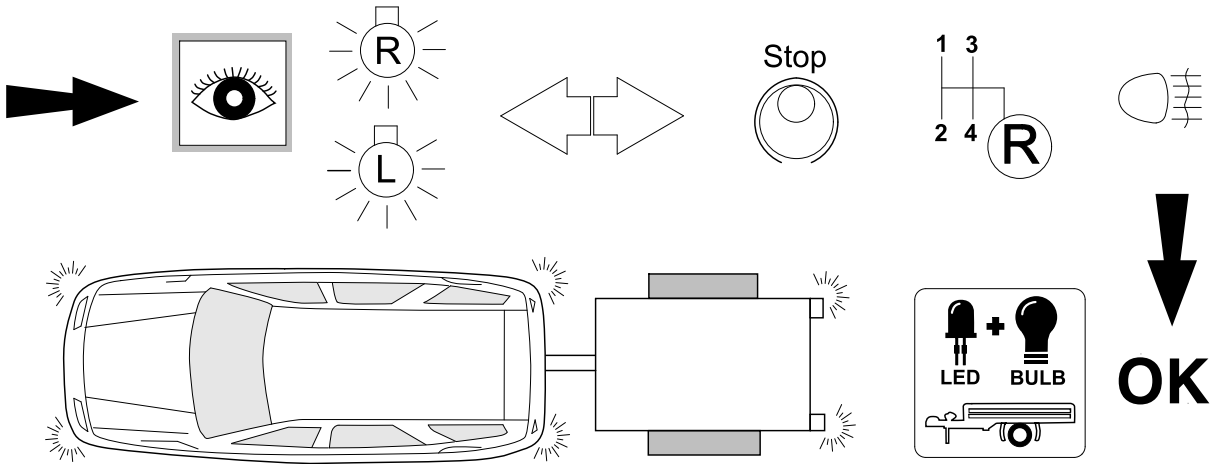

**27 OPTIONAL**

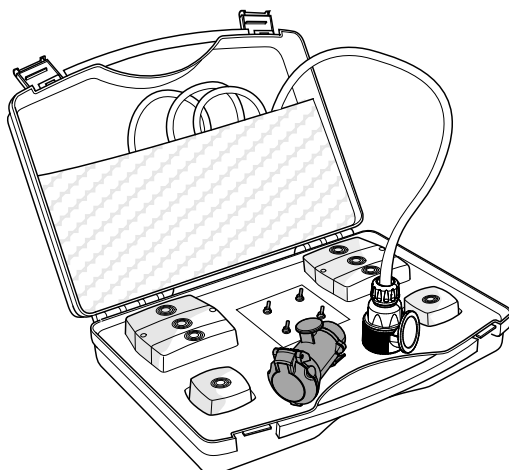

**Trailer Simulator  
for 7p and 13p sockets**

**765069**

## 28 CHECK

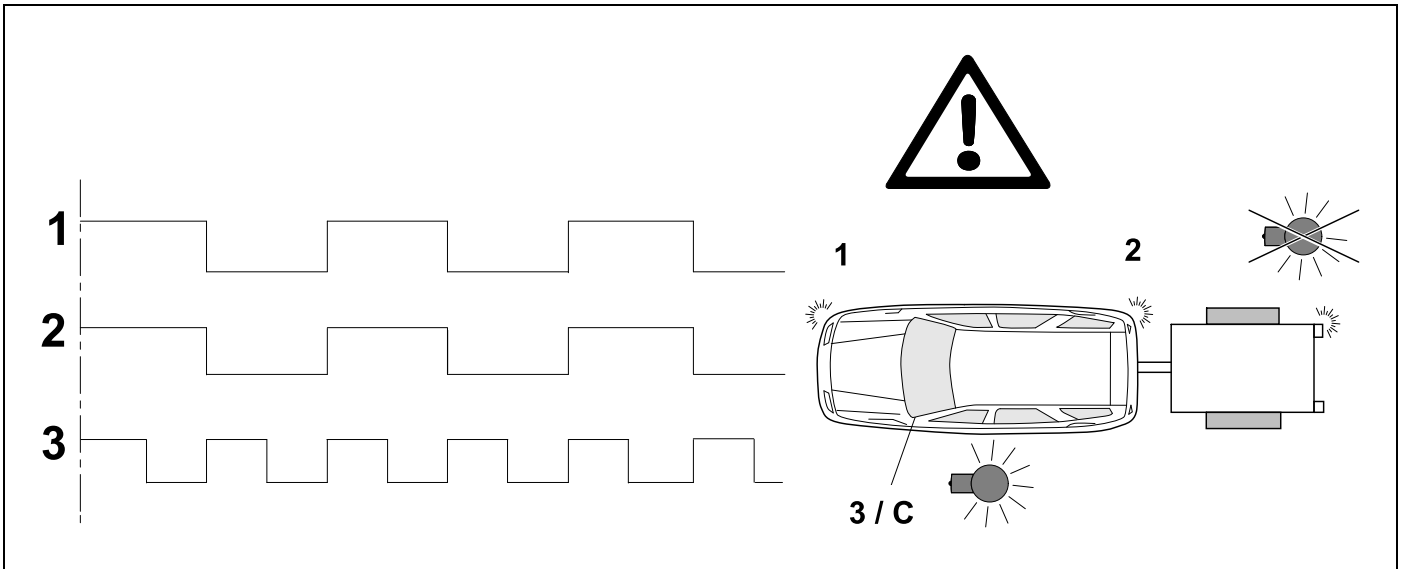

## 29 INFORMATION



16

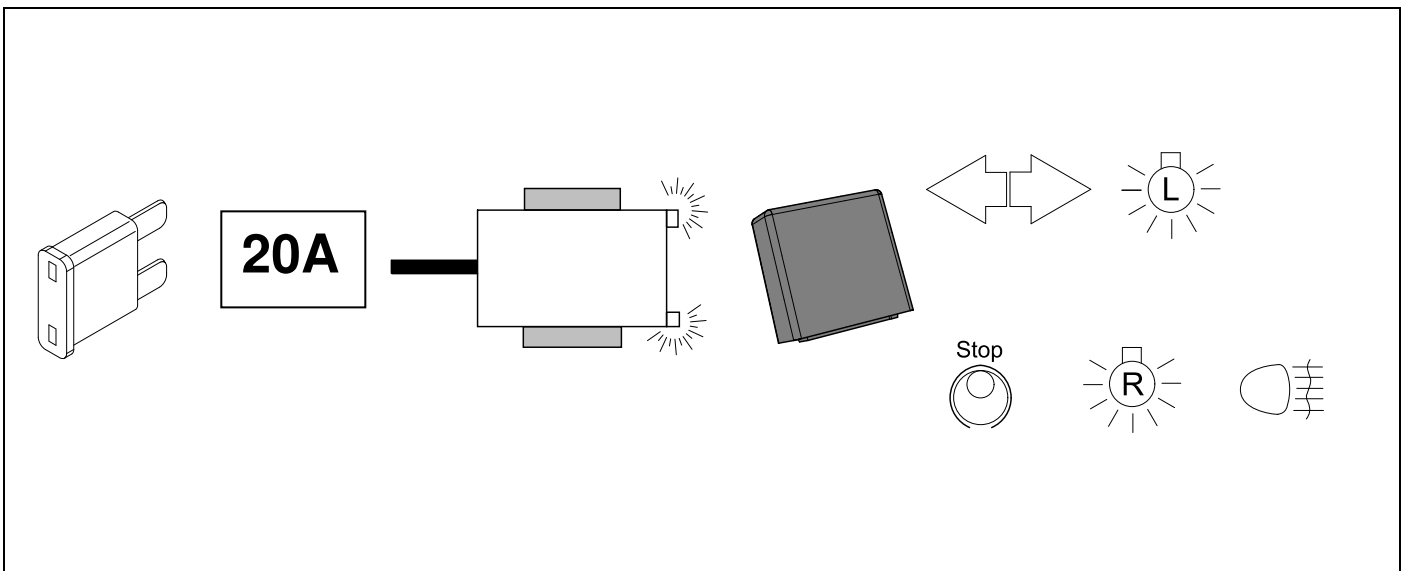

## 30 INFORMATION

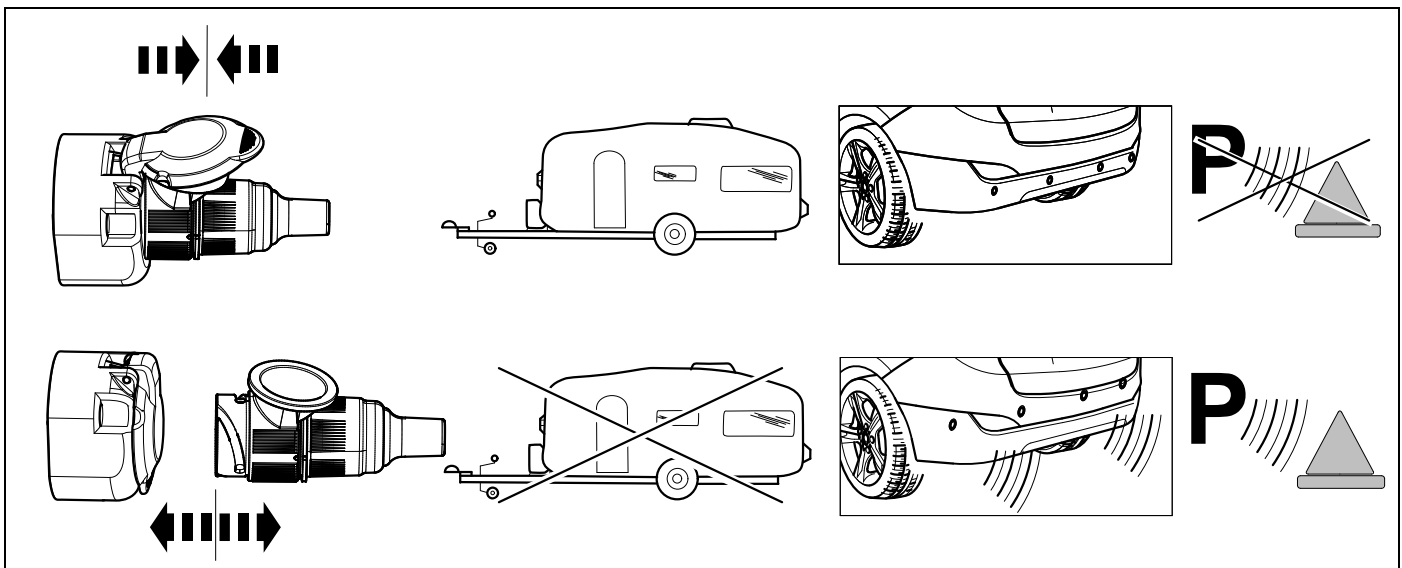

# 31 INFORMATION

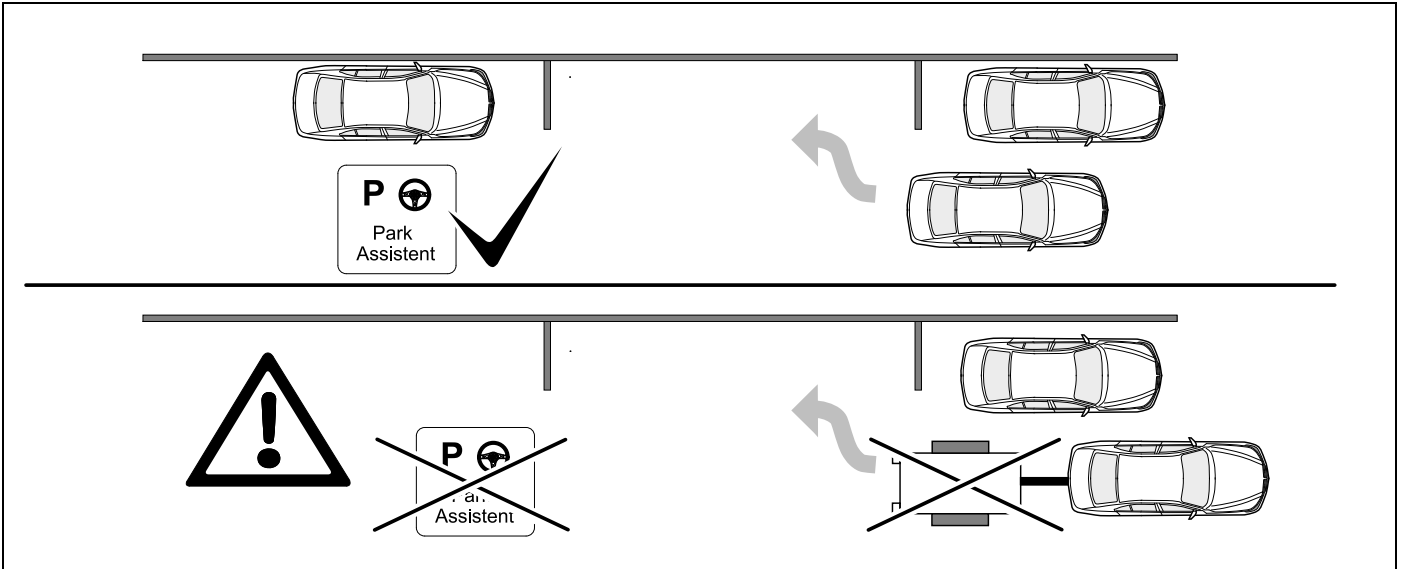

# 32 OPTIONAL



**BRiNK**

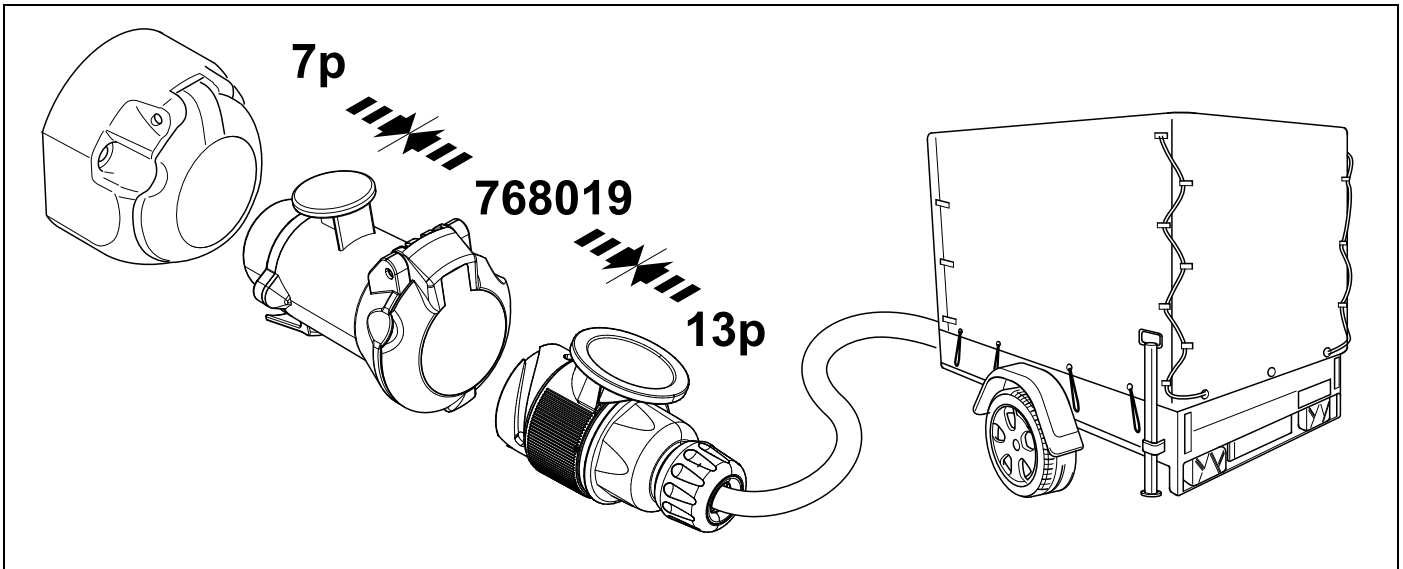

# 33 PLEASE NOTICE

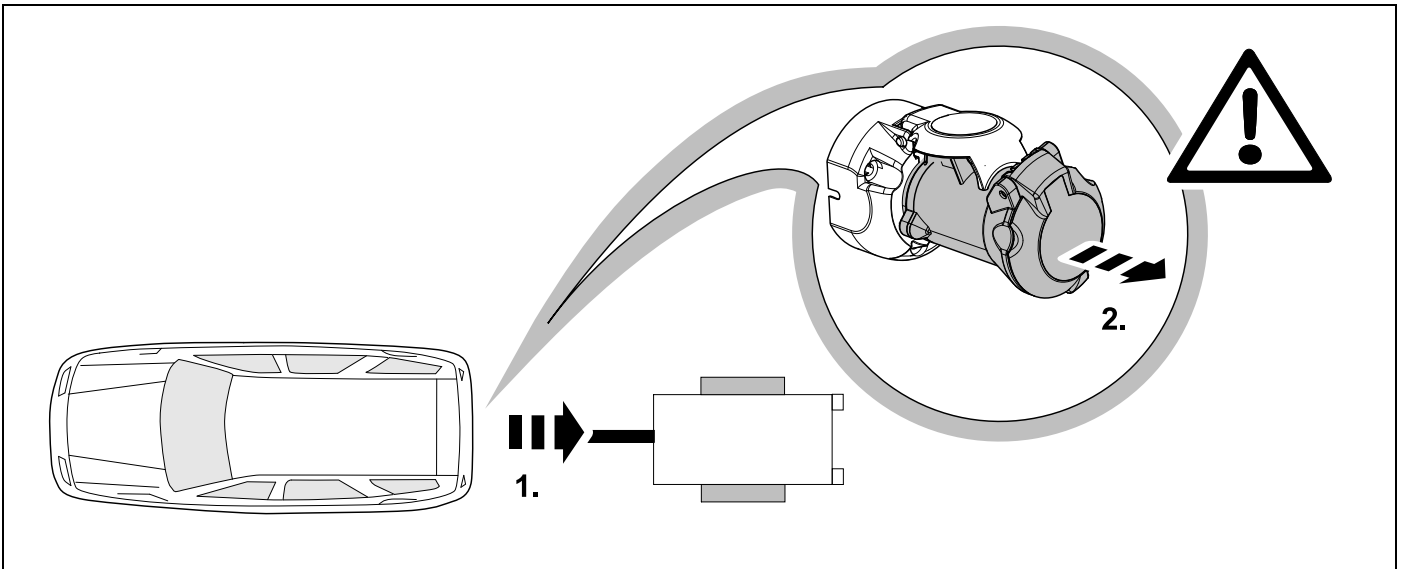

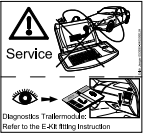
  
Service  
Diagnostics Trailermodule:  
Refer to the E-Kit fitting instruction

**10**

**2x**

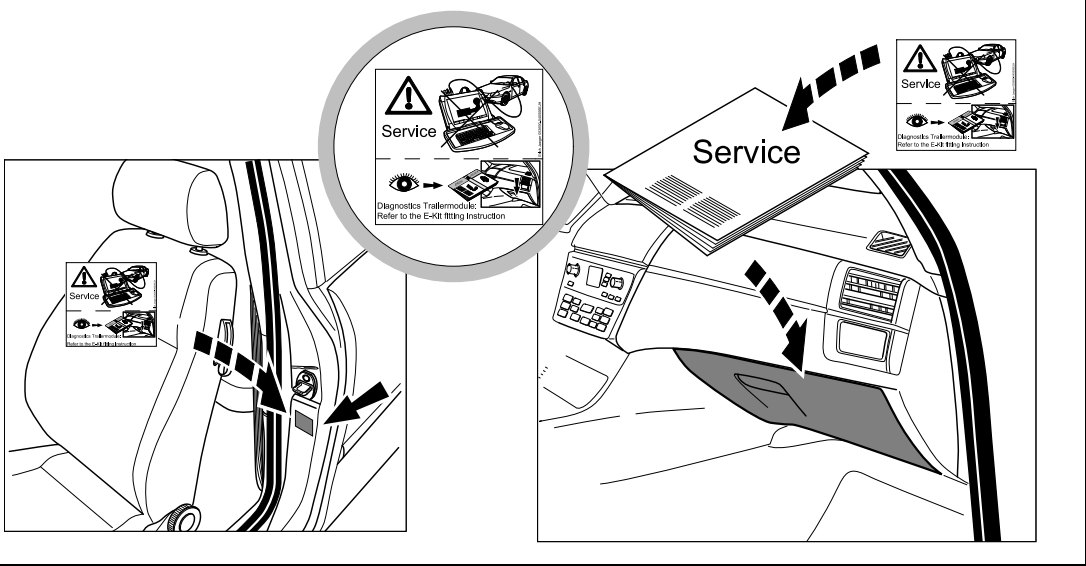

# Status LED für Eigendiagnose

# Status LED for self-diagnosis

## Operation support

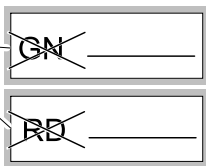
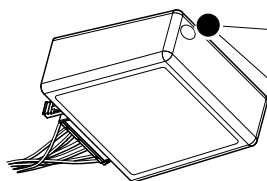
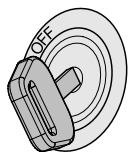

No CAN-Data =



Standby / Sleepmode



Ignition OFF

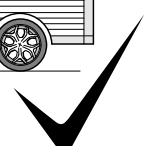
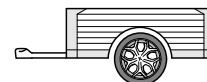
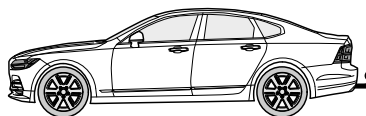
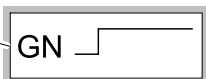
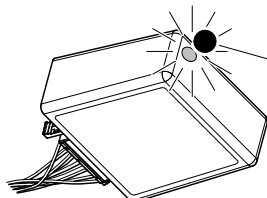

Ignition ON

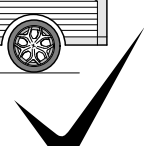
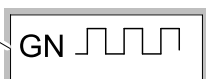
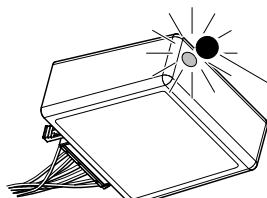

Ignition ON

## Failure support

## Check CAN-Data Wire

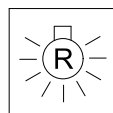
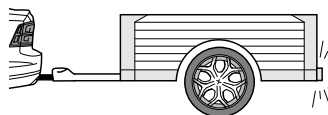
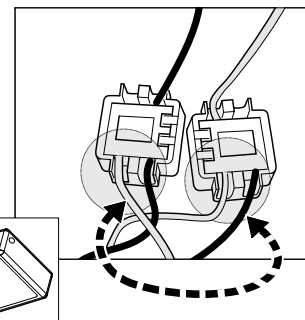
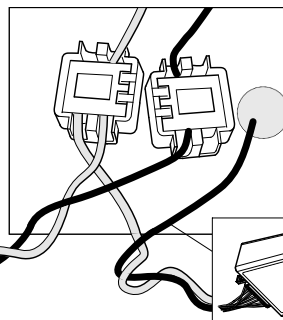
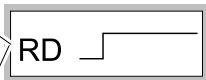
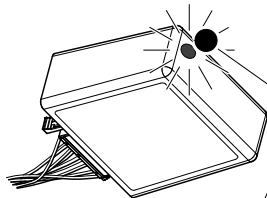

+

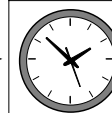
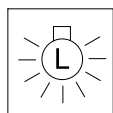

1x max 5 min.

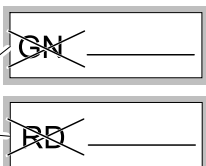
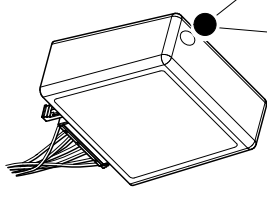

PIN 17

oder / or



PIN 1

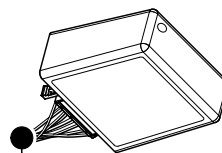
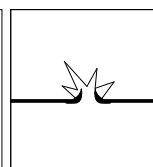
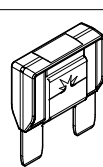
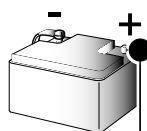

Ignition ON











<p><b>D</b> Änderungen bezüglich Konstruktion, Ausstattung Farbe sowie Irrtum vorbehalten. Angaben und Abbildungen unverbindlich</p>	<p><b>PL</b> Zastrzega się prawo do zmian dot. konstrukcji, wykończenia, kolorystyki oraz pomyłek. Dane i ilustracje niewiążące.</p>
<p><b>GB</b> Subject to change in terms of construction, equipment and colour, and may contain errors. The information and illustrations are non-binding.</p>	<p><b>TR</b> Tasarım, donanım ve renk bakımından değişiklik yapma hakkı ve hata ve eksiklik mahfuzdur. Veriler ve resimler bağlayıcı değildir.</p>
<p><b>F</b> Sous réserve de modifications de la construction, de l'équipement, de la couleur et sous réserve d'erreurs. Les indications et les illustrations sont sans engagement.</p>	<p><b>H</b> A szerkezet, a kivitell és a szín változtatása, valamint a változások joga fenntartva. Az adatok és az ábrák nem kötelező érvényűek.</p>
<p><b>NL</b> Wijzigingen met betrekking tot constructie, uitvoering en kleur evenals vergissingen voorbehouden. Gegevens en afbeeldingen zijn niet bindend.</p>	<p><b>HR</b> Pravo promjena u svezi konstrukcije, opreme, boje kao i zabune oridžavamo. Podaci i ilustracije su neobavezne.</p>
<p><b>DK</b> Ændringer med hensyn til konstruktion, udstyr, farver samt fejl forbeholdes. Oplysninger og illustrationer er uforpligtende.</p>	<p><b>BUL</b> Запазени права по отношение на конструкцията, обзавеждането, цвета и грешки. Данните и изображенията не са обвързващи.</p>
<p><b>N</b> Endringer angående konstruksjon, utstyr, farge og feiltagelse forbeholdes. Oplysninger og illustrasjoner uforbindtlig.</p>	<p><b>RO</b> Ne rezervăm dreptul unor modificări ale construcției, dotării, culorii și dreptul la erori Datele indicate și imaginile sunt orientative.</p>
<p><b>S</b> Med reservation för ändringar vad det gäller konstruktion, utrustning, färg samt för misstag. Uppgifterna och bilderna är inte bindande.</p>	<p><b>RU</b> Права на внесение изменений относительно конструкции, оснащения, окраски, а также на ошибки сохраняются. Данные и иллюстрации имеют примерный характер.</p>
<p><b>FIN</b> Pidätämme oikeuden rakennetta, varustusta, väriä koskeviin sekä erehdyksestä johtuviin muutoksiin. Tiedot ja kuvat eivät ole sitovia.</p>	<p><b>LT</b> Pasiliekaama konstrukcijos, įrangos bei reikmenų, spalvos pakeitimų ir klaidų teisė. Duomenys ir iliustracijos neįpareigojantys.</p>
<p><b>I</b> Con riserva di modifiche relative a progettazione, dotazione, colore ed errori. Le indicazioni e figure sono fornite senza impegno.</p>	<p><b>LV</b> Tiek paturētas tiesības uz konstrukcijas, iekārtu, krāsu izmaiņām, kā arī kļūdīšanās. Dati un attēli bez saistībām.</p>
<p><b>E</b> Reservadas las modificaciones respecto a diseño, equipamiento, color, así como error. Indicaciones y figuras sin compromiso.</p>	<p><b>EST</b> Konstruktsiooni, varustuse ja võervi osas muudatused ning eksimine lubatud. Andmed ja joonised on mittesiduvad.</p>
<p><b>P</b> Reservamos o direito de alterações relativamente ao desenho, equipamento, cor, bem como de erro. Os dados e as gravuras não implicam compromisso da nossa parte.</p>	<p><b>SLO</b> Zadržana pravica do sprememb glede konstrukcije, opreme, barve ter pomote. Podatki in slike so neobvezne.</p>
<p><b>GR</b> Διατηρώνουμε κάθε επιφύλαξη ως προς αλλαγές σε σχέση με κατασκευή, εξοπλισμό, διαρρυθμίση, χρωματισμούς και λάθη παραδρομής.</p>	<p><b>SK</b> Zmeny, ktoré sa týkajú konštrukcie, vybavenia, farby, ako aj omyly sú vyhradené. Údaje a zobrazenia sú nezáväznú.</p>
<p><b>CZ</b> Změny, týkající se konstrukce, vybavení, barvy, jakož i omyly jsou vyhrazeny. Údaje a vyobrazení jsou nezávazné.</p>	