

Kit 1361

HYUNDAI Tucson, 5-dr SUV, 04–
HYUNDAI JM, 5-dr SUV, 04– (JPN)

480R
754

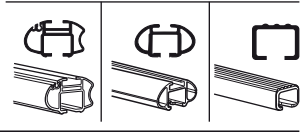
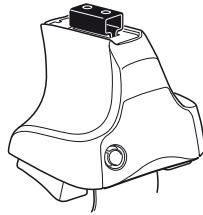

480

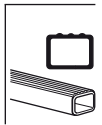
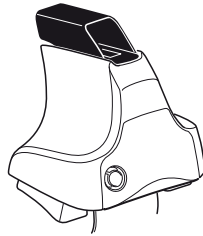

750

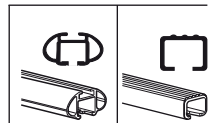
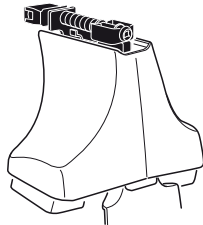

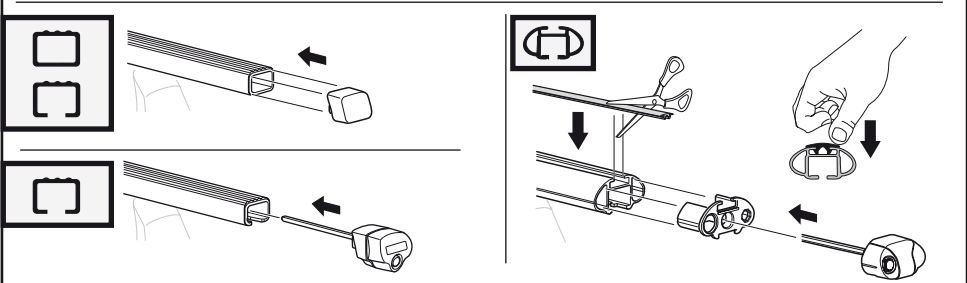
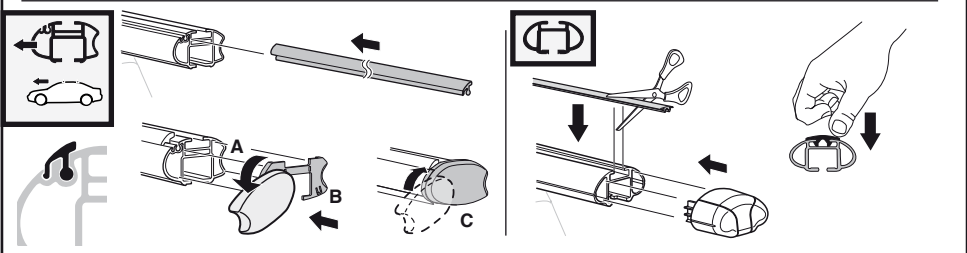
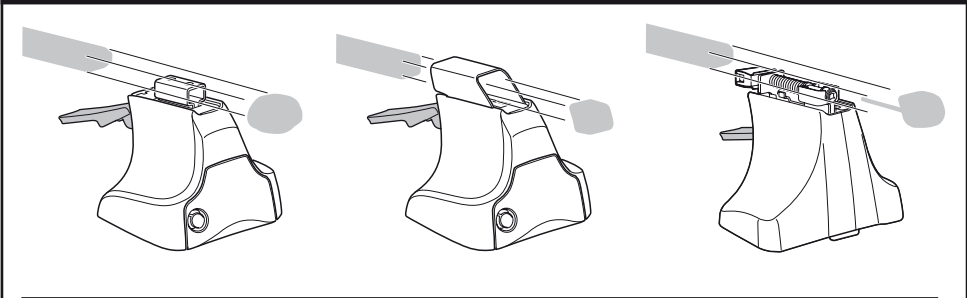
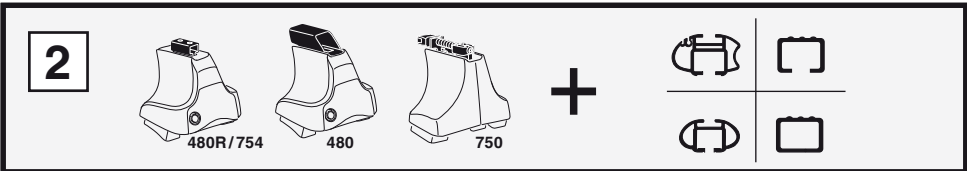
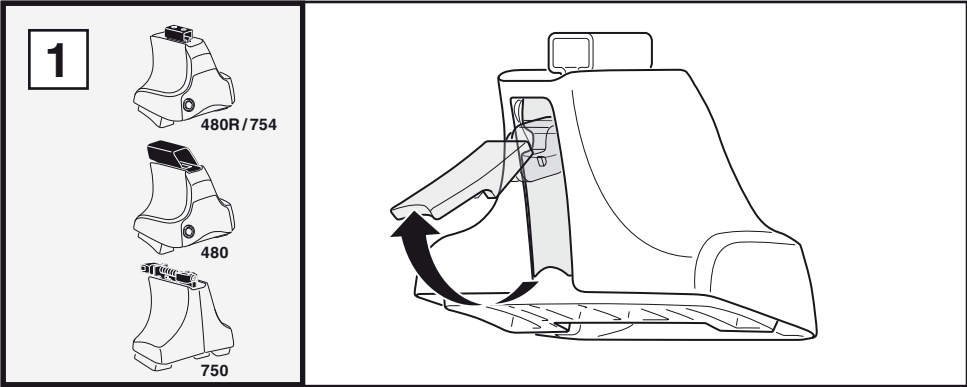

3

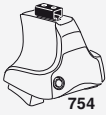

754

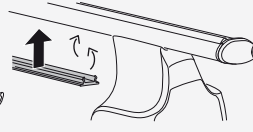
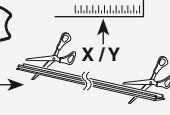

750



1

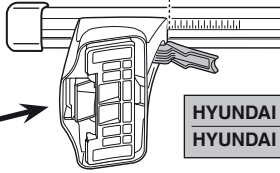
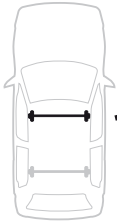

2

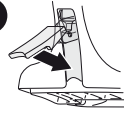

	X
HYUNDAI Tucson, 5-dr SUV, 04-	41,5
HYUNDAI JM, 5-dr SUV, 04- (JPN)	41,5

X

41,5

1

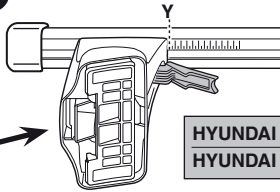

2



	Y
HYUNDAI Tucson, 5-dr SUV, 04-	40,5
HYUNDAI JM, 5-dr SUV, 04- (JPN)	40,5

Y

40,5



480R



480

1

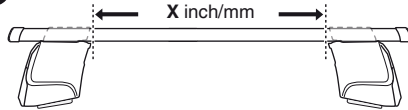

2

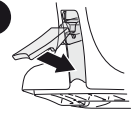

	X inch	X mm
HYUNDAI Tucson, 5-dr SUV, 04-	42"	1066 mm
HYUNDAI JM, 5-dr SUV, 04- (JPN)	42"	1066 mm

X inch

X mm

42"

1066 mm

1

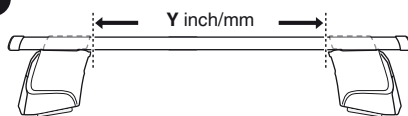

2

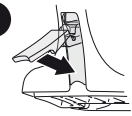

	Y inch	Y mm
HYUNDAI Tucson, 5-dr SUV, 04-	41 ⁵ / ₈ "	1056 mm
HYUNDAI JM, 5-dr SUV, 04- (JPN)	41 ⁵ / ₈ "	1056 mm

Y inch

Y mm

41 ⁵/₈"

1056 mm

4

HYUNDAI Tucson, 5-dr SUV, 04-
 HYUNDAI JM, 5-dr SUV, 04- (JPN)

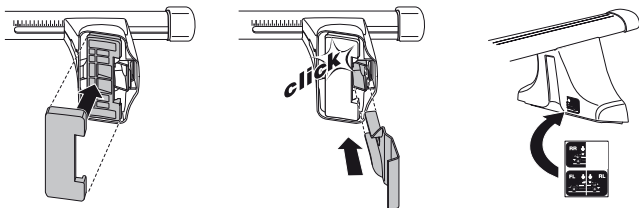
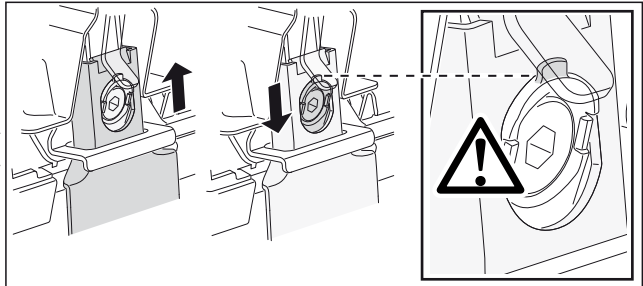
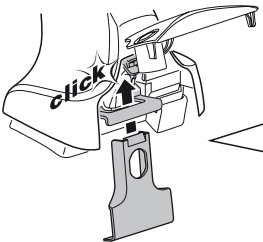
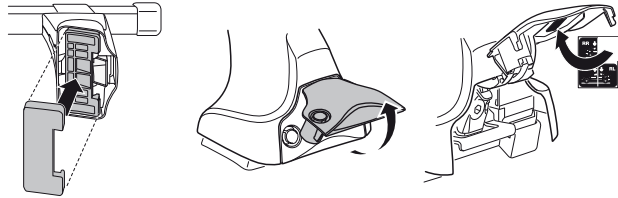
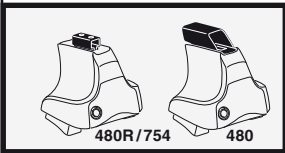
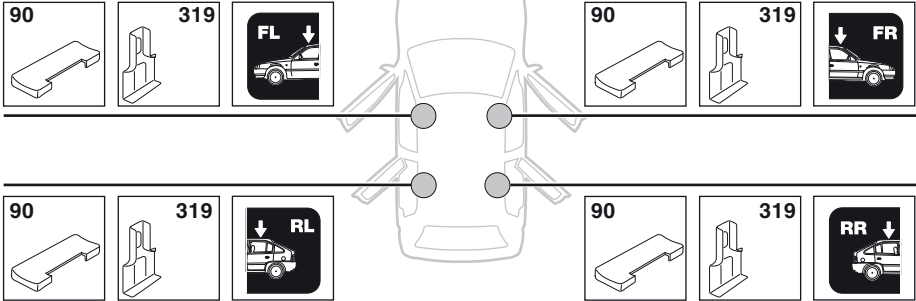

5

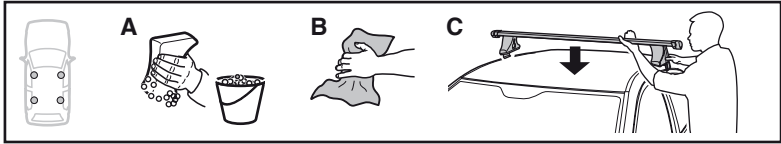

	X mm	Y mm	X inch	Y inch
HYUNDAI Tucson, 5-dr SUV, 04-	330 mm	680 mm	13"	26 3/4"
HYUNDAI JM, 5-dr SUV, 04- (JPN)	330 mm	680 mm	13"	26 3/4"

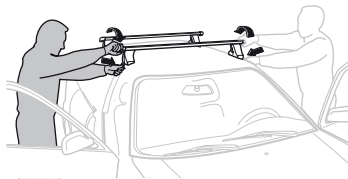
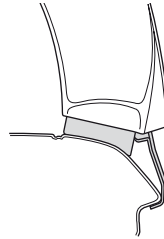
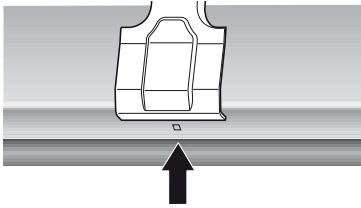
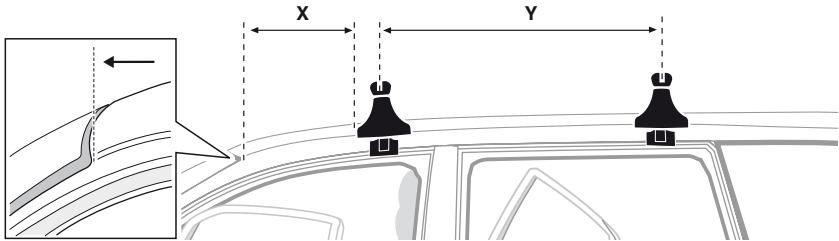

GB/US Tighten alternately

D Die Schrauben abwechselnd anziehen

F Serrer alternativement chaque côté

NL Afwisselend aan de linker- en de rechterkant aandraaien

I Alternare il serraggio delle viti

E Apretar alternativamente

PT Aperte alternadamente

S Dra åt växelvis

FIN Kierrä vuorotellen

EST Pinguldage vaheldumisi

LAT Pielieciet pamišus

LIT Užsukinėkite pakaitomis

PL Śruby dokręcaj naprzemiennie

RU Затягивайте попеременно

CZ Pokręťta bagażníka dokręcaj dokręcaj naprzemiennie.

SK Doťahujte striedavo

SLO Privijajte izmenično.

HR Naizmjenično zategnite

HU Egymástól függetlenül szorítandó

GR Σφίγγετε εναλλάξ

TR Dönüşümlü sıkın

中文 交替拧紧

한국어 번갈아 가며 조이십시오.

日本語 交互に締め付けてください。

ไทย ชั้นโน้แบบสลับ

6



480R/754



480

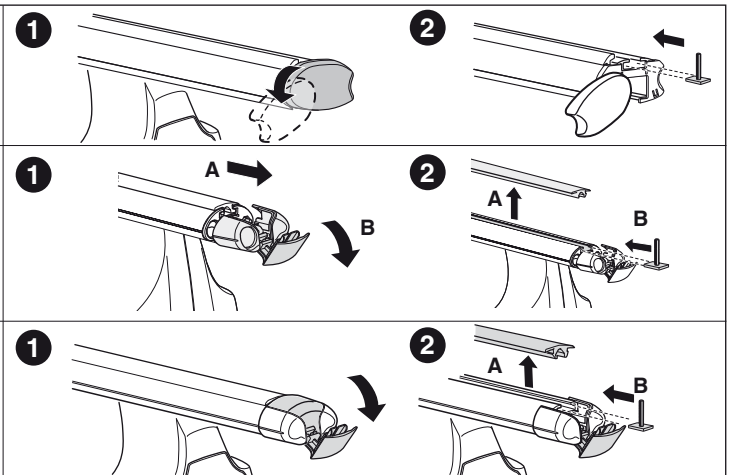
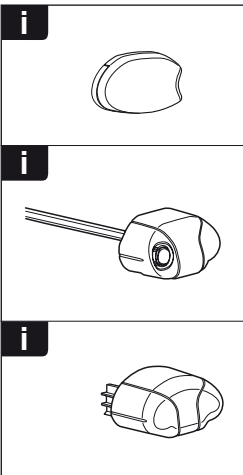
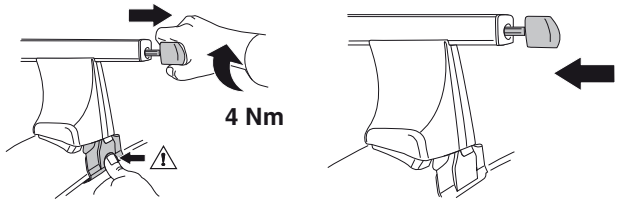
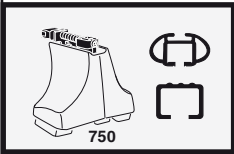
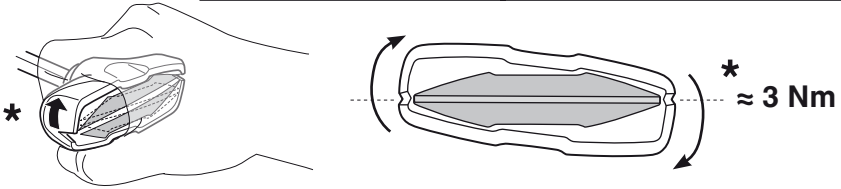
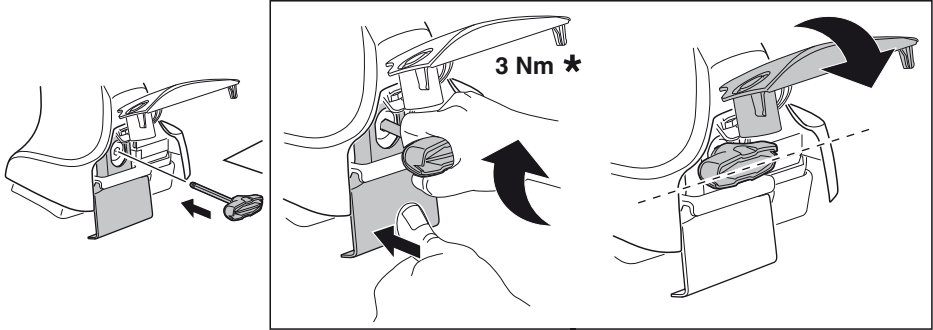

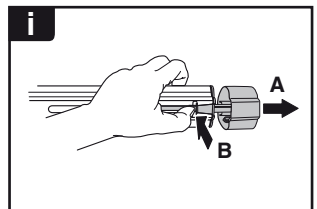
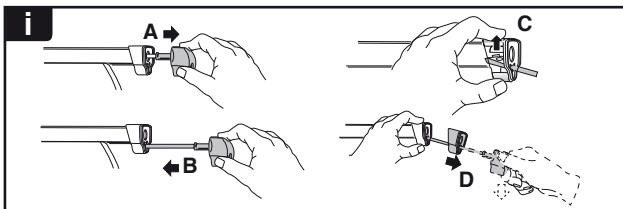
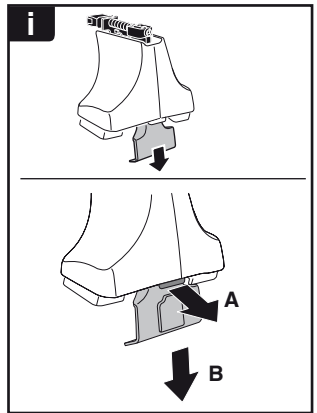
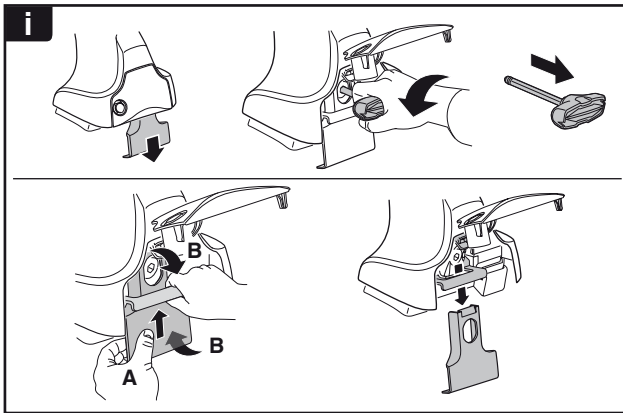
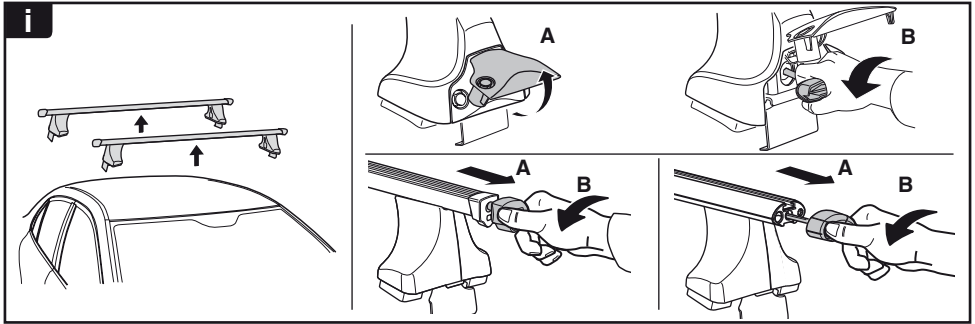

THULE
SWEDEN
**ONE
KEY
SYSTEM**

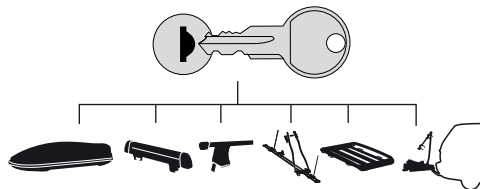

- 544 (x4)
- 596 (x6)
- 588 (x8)
- NA 510 (x10)
- EUR 452 (x12)
- ASIA

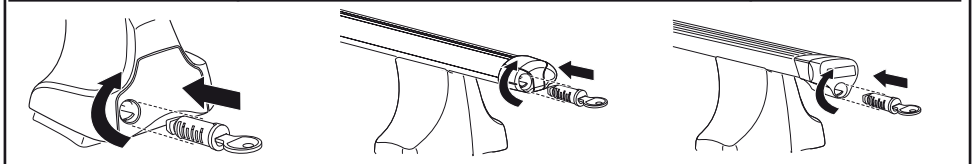

WW ▶ Thule Sweden AB, Box 69, 330 33 Hillerstorp, SWEDEN
NA ▶ Thule Inc., 42 Silvermine Road, Seymour, Connecticut 06483, USA

info@thule.com
customer.service@thule.com

www.thule.com