



PROFESSIONAL DUAL PURPOSE

De största fördelarna

- Utformat för äldre husbilar, husvagnar och båtar



Mer information finns på www.varta-automotive.com

ORDERINFORMATION

| | |
|--------------------|-------------------|
| ETN: | 930 075 065 |
| Artikelnummer: | 930 075 065 B91 2 |
| Kortnummer: | LFD 75 |
| Streckkod: | 4016987141113 |
| Förpackningsenhet: | 1 |
| Palett: | 48 |

TEKNISK INFORMATION

| | | | |
|-----------------------------------|-----|------------------------|--------|
| Volttal [V]: | 12 | Höjd [mm]: | 190 |
| Batterikapacitet [Ah]: | 75 | Bottenklack: | B13 |
| Batterikapacitet 5h [Ah]: | 64 | Polställning: | 0 |
| Kallstartström CCA EN [A]: | 650 | Poltyp: | 1 |
| Marine Cranking Amps (SAE) @ 0°C: | 813 | Höljets storlek: | H6/L3 |
| Längd [mm]: | 278 | Vikt fyllt och laddat: | 19,500 |
| Bredd [mm]: | 175 | | |

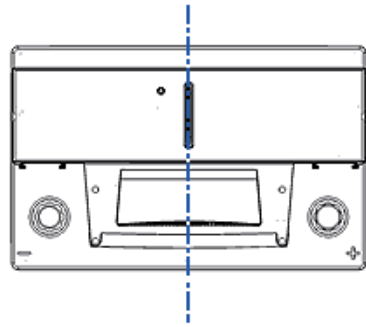
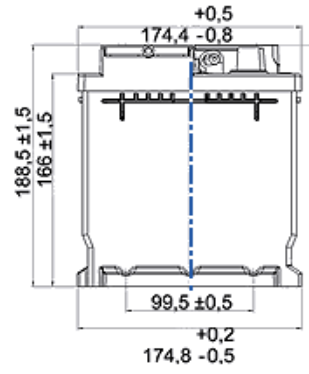
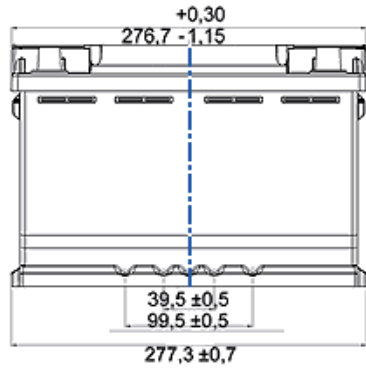

Terminal
POSITIVE



NEGATIVE

