



Thule XT Kit 3175

> Instructions

CITROËN Berlingo, 4-dr Van, 19-
OPEL Combo, 4-dr Van, 19-
OPEL Combo Life, 5-dr MPV, 19-
PEUGEOT Partner, 4-dr Van, 19-
TOYOTA Proace City, 4-dr Van, 20-
VAUXHALL Combo, 4-dr Van, 19-
VAUXHALL Combo Life, 5-dr MPV, 19-

This kit is only for vehicles with fixpoint mounting.

The diagram illustrates the kit's contents and usage. On the left, a silhouette of a person reads instructions. The kit includes two FootPacks (751 and 753) and a Security padlock. The weight limits are shown as follows:

- xx kg / xx lbs + 6 kg / 13 lbs = Max. 100 kg / 220 lbs
- xx kg / xx lbs + 9 kg / 20 lbs = Max. 150 kg / 330 lbs

On the right, two diagrams show the installation of the rack on a vehicle roof. The top diagram shows the rack being secured with a padlock. The bottom diagram shows the rack being secured with a padlock and a speed limit sign indicating a maximum speed of 80 km/h (50 Mph) or 130 km/h (90 Mph).

ISO 11154-E

183175

C.20200610
5560249001

Bring your life
thule.com

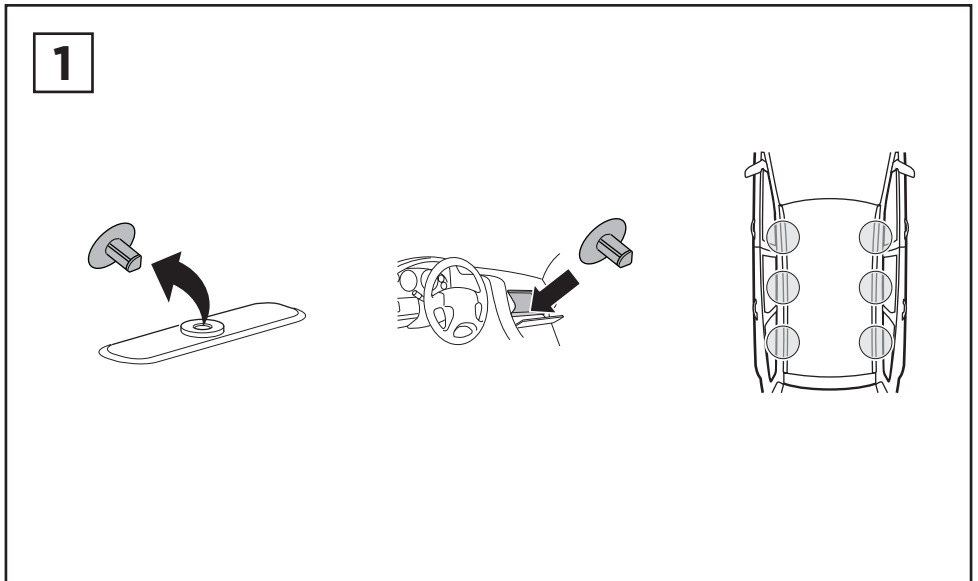
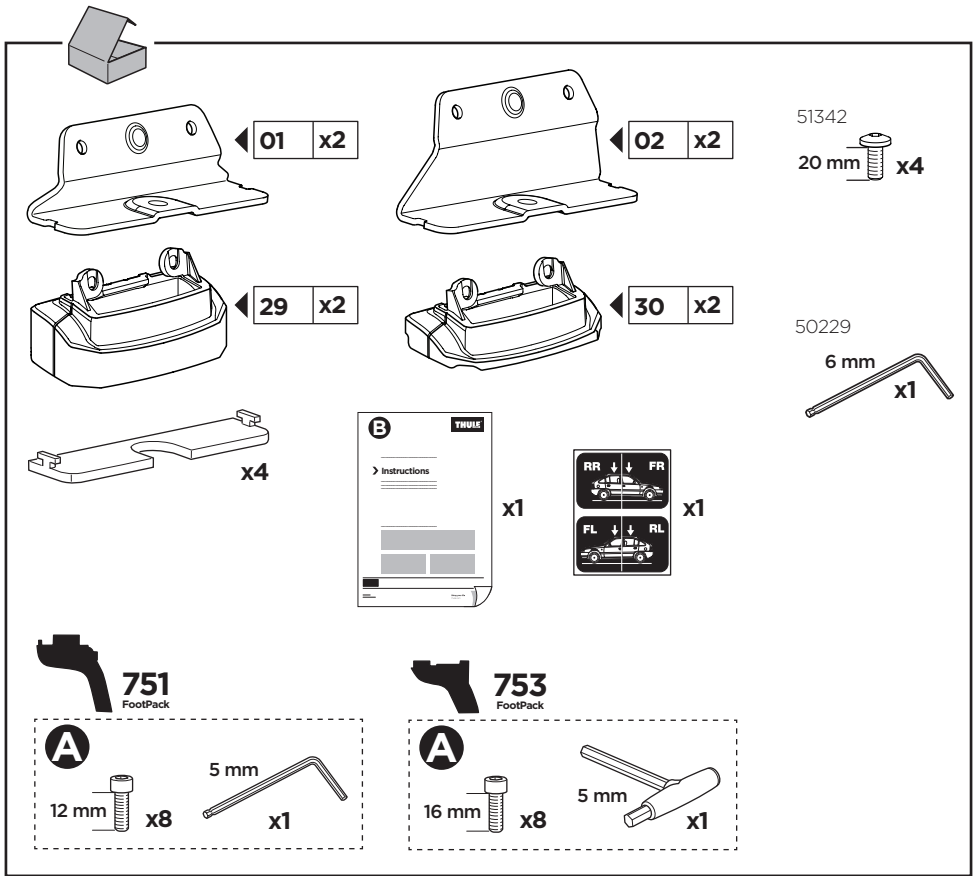

2

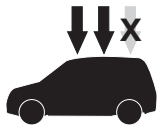
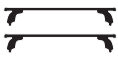

753 FootPack

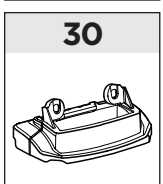
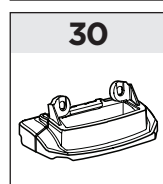
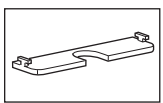
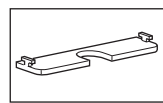
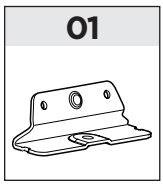
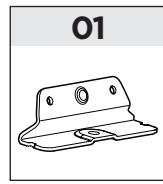
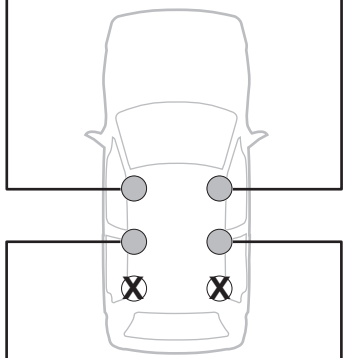
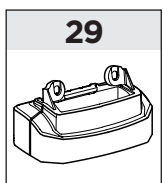
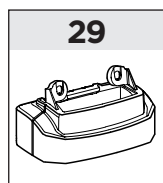
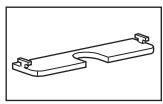
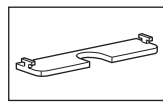
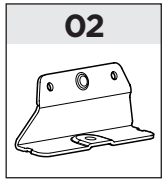
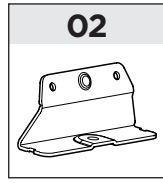

2

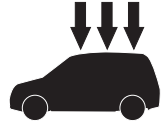

751
FootPack

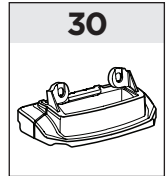
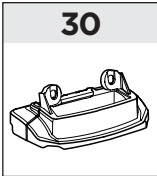
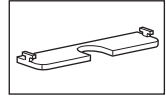
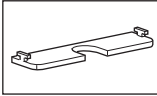
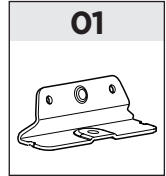
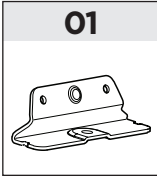

753
FootPack

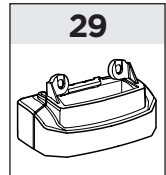
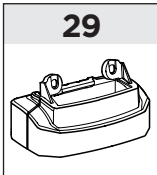
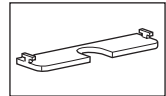
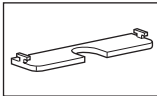
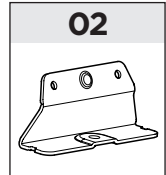
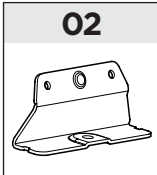

3 753 FootPack

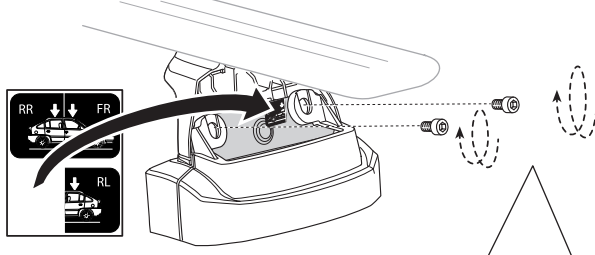
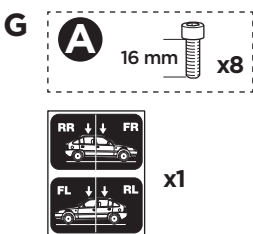
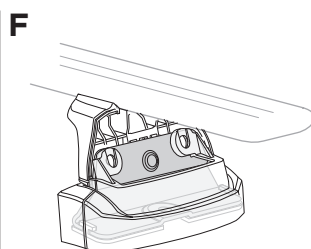
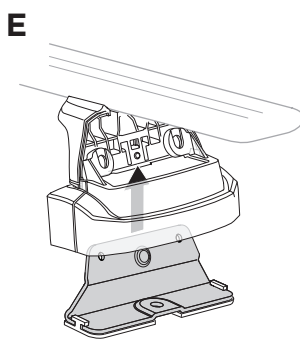
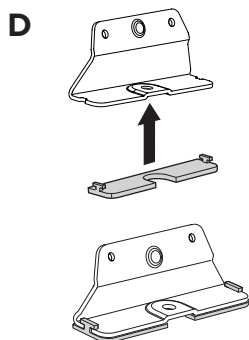
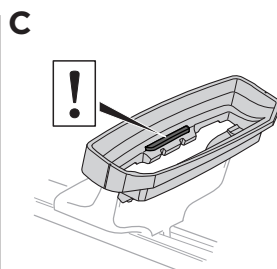
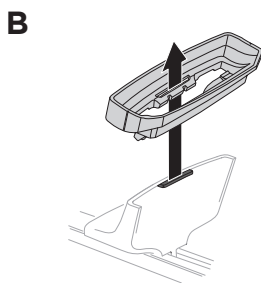
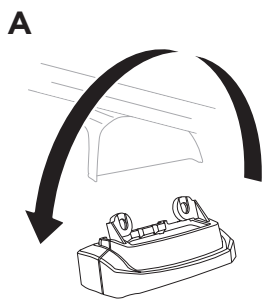

EN Only a few turns
DE Nur wenige Umdrehungen
FR Quelques tours uniquement
NL Slechts enkele slagen
IT Solo qualche giro
ES Sólo algunas vueltas
PT Noções básicas
SV Endast några varv
DK Kun nogle få omgange
NE Bare noen få omdreinger
FI Vain muutama kierros

ET Ainult mõni pööre
LV Tikai dažī apgriezieni
LT Tik keli pasukimai
PL Wystarczy kilka obrotów
RU Только несколько оборотов
UK Лише декілька обертів
BG Само няколко завъртания
CS Pouze několik otáček
SK Len niekoľko otáčok
SL Le nekaj obratov
HR/BIH Samo nekoliko okreta

RO Doar câteva rotiri
HU Csak néhány fordítás
EL Μόνο λίγες περιστροφές
TR Yalnızca birkaç tur

بعض دورات فقط **AR**
 רק מספר סיבובים **HE**
ZH 仅几圈
JA 2 ~ 3 回転のみ
KO 몇 번만 돌리면 됨
TH เพียงสองสามรอบ

3



751
FootPack

A

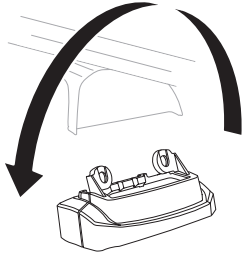

B

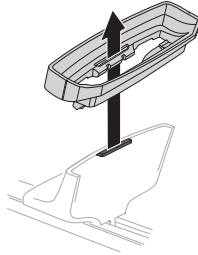

C

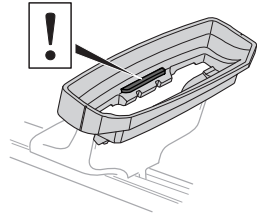

D

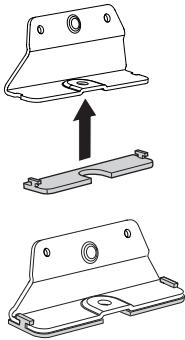

E

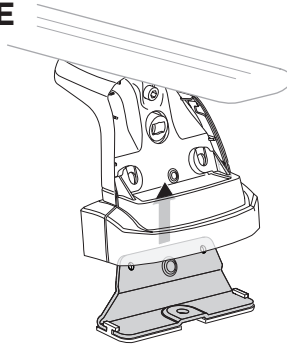

F

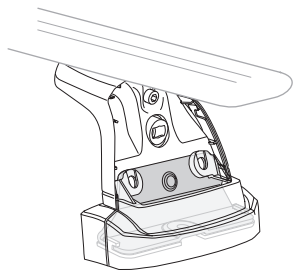

G

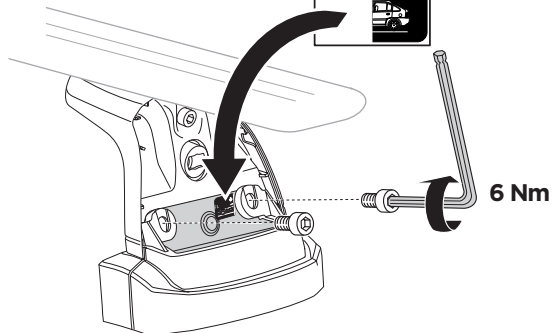
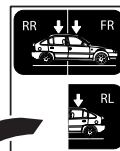
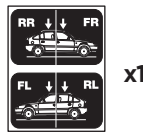
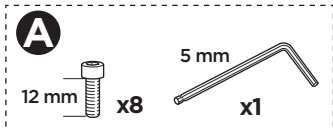

4

753
FootPack

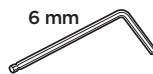
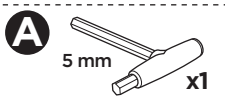

A

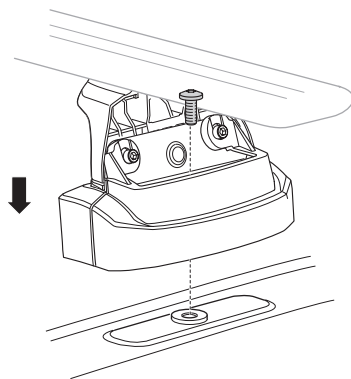

B

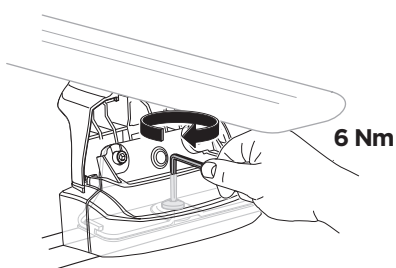
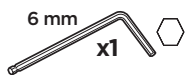

C

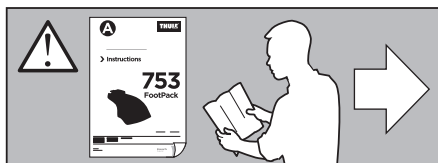
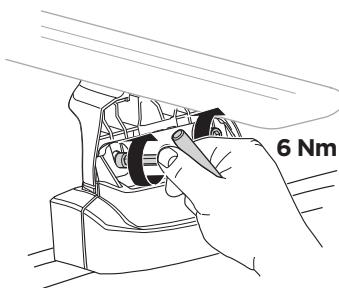
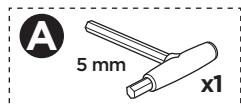

4



751
FootPack

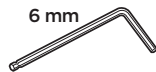
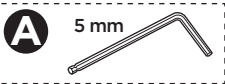

A

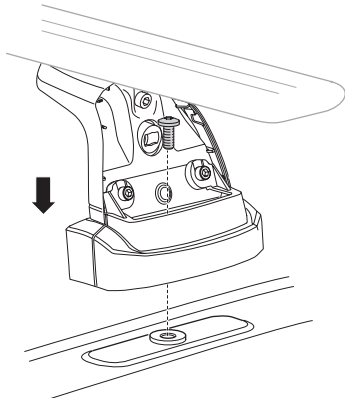

B

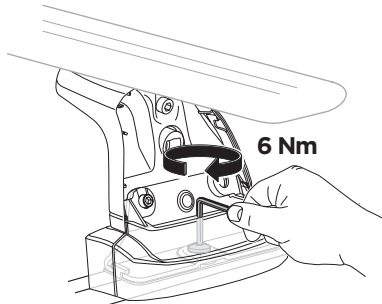
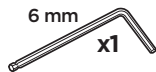

C

