

Kit 1411

TOYOTA Corolla Fielder, 5-dr Estate, 06-

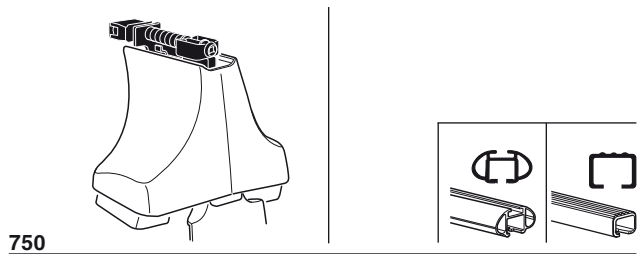
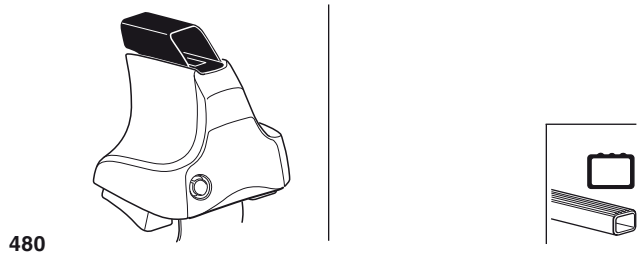
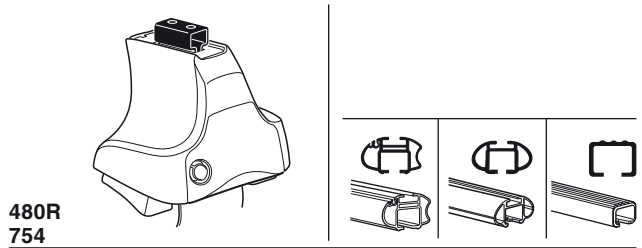

xx kg
 xx lbs + 7 kg
 15,4 lbs = **Max. 60kg**
Max. 132 lbs

80 km/h 50 Mph 130 km/h 80 Mph
 40 km/h 25 Mph
km/h Mph

THULE + **Kit XXXX**

x4 x4 x4

480R/754

x4 x4 x4

480

x4 x4

750

x2	x2	x2	x2	x2
x2		x2	x2	
x2		x4	x2	
x4		x4		

829 x2
830 x2

173 x1
175 x1
248 x2

x1

Kit



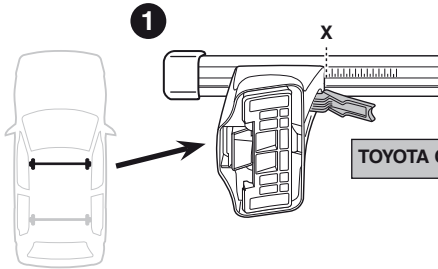

X
TOYOTA Corolla Fielder, 5-dr Estate, 06-
33

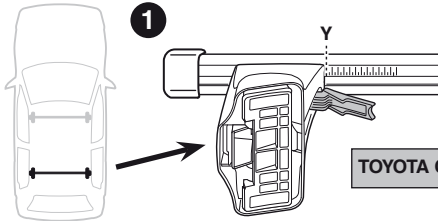

Y
TOYOTA Corolla Fielder, 5-dr Estate, 06-
30,5

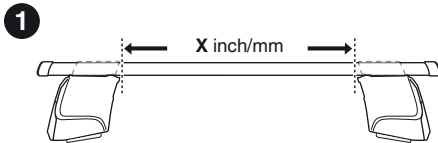
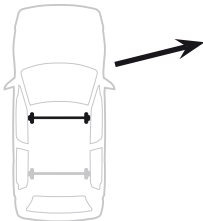

X inch	X mm
TOYOTA Corolla Fielder, 5-dr Estate, 06-	
38 5/8"	981 mm

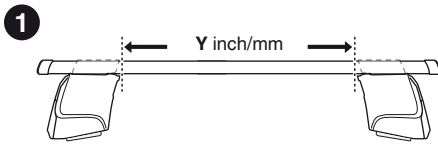
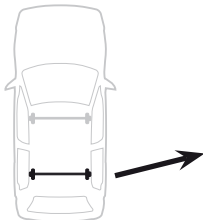
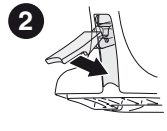

Y inch	Y mm
TOYOTA Corolla Fielder, 5-dr Estate, 06-	
37 5/8"	956 mm

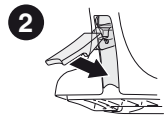

4

TOYOTA Corolla Fielder, 5-dr Estate, 06-

173



829



175



829

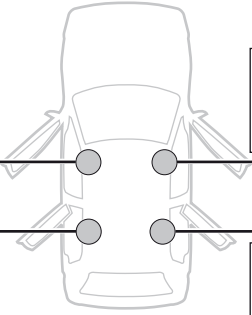

248



830



248



830

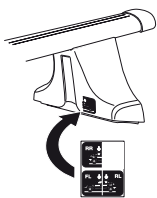
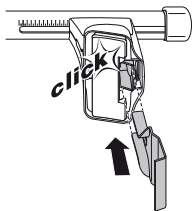
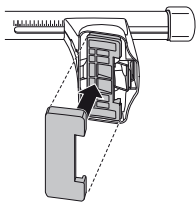
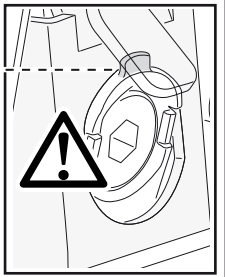
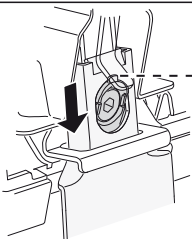
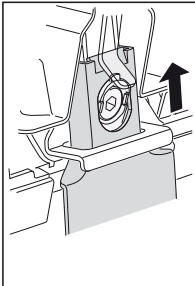
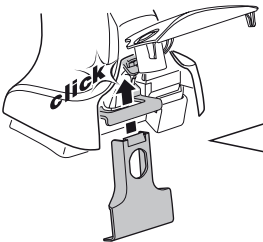
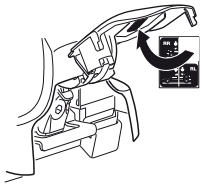
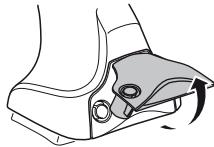
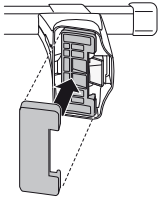
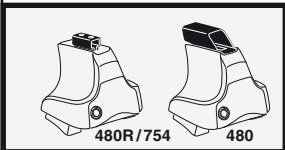

5

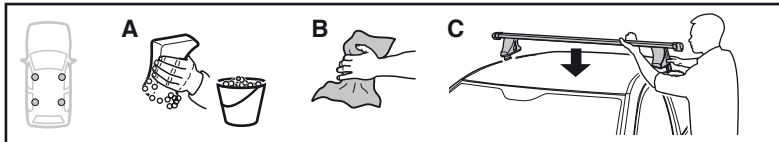

TOYOTA Corolla Fielder, 5-dr Estate, 06-

X mm	Y mm	X inch	Y inch
270 mm	710 mm	10 ⁵ / ₈ "	28 "

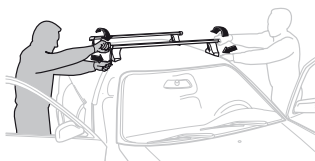
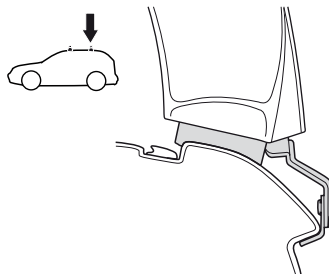
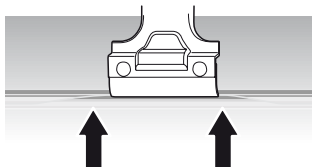
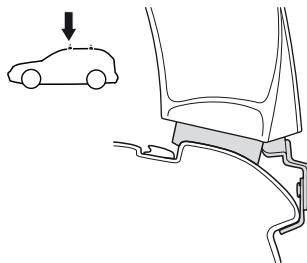
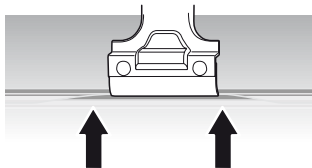
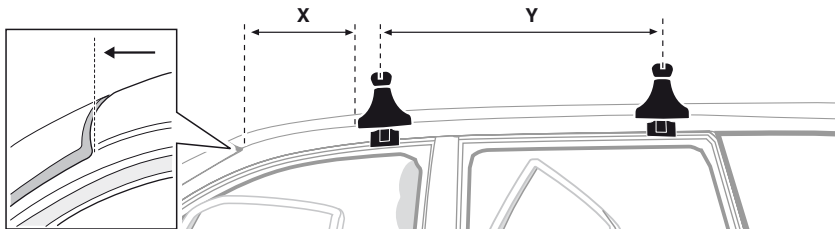

GB/US Tighten alternately
D Die Schrauben abwechselnd anziehen
F Serrer alternativement chaque côté
NL Afwisselend aan de linker- en de rechterkant aandraaien
I Alternare il serraggio delle viti
E Apretar alternativamente
PT Aperte alternadamente
S Dra åt växelvis
FIN Kierrä vuorotellen
EST Pinguldage vaheldumisi
LAT Pievelciēt pamīšus
LIT Užsukinėkite pakaitomis
PL Śruby dokręcaj naprzemiennie
RU Затягивайте попеременно

CZ Pokręťta bagażníka dokręcaj dokręcaj naprzemiennie.
SK Dotahujte striedavo
SLO Privijajte izmenično.
HR Naizmjerno zategnite
HU Egymástól függetlenül szorítandó
GR Σφιγγείτε εναλλάξ
TR Dönüşümlü sıkın

中文 交替拧紧

한국어 번갈아 가며 조이십시오.

日本語 交互に締め付けてください。

ไทย ขั้นในแบบสลับ

6



480R/754



480

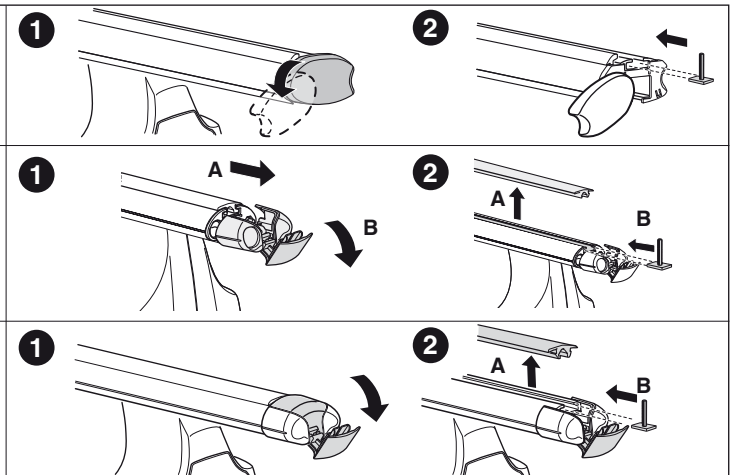
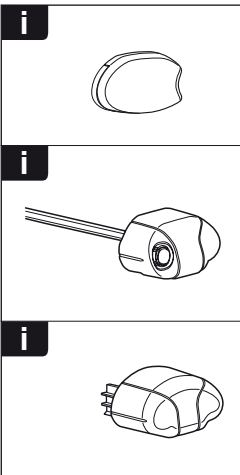
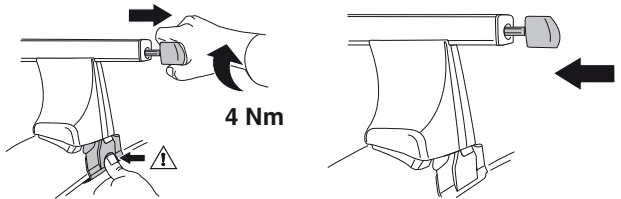
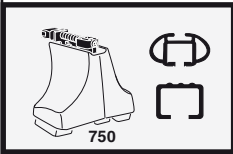

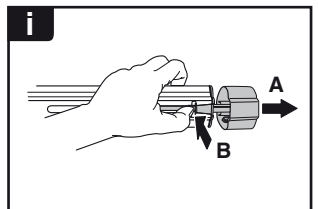
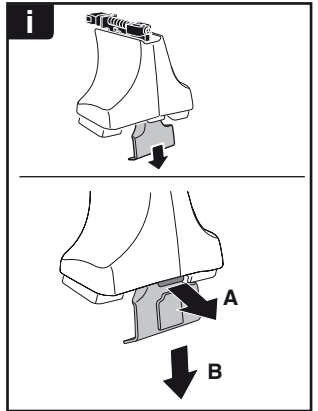

THULE
SWEDEN
**ONE
KEY
SYSTEM**



		(x4)
		(x6)
		(x8)
NA		(x10)
EUR		(x12)
ASIA		(x12)



WW ▶ Thule Sweden AB, Box 69, 330 33 Hillerstorp, SWEDEN
NA ▶ Thule Inc., 42 Silvermine Road, Seymour, Connecticut 06483, USA

info@thule.com
customer.service@thule.com

www.thule.com