

Kit 1180

AUDI TT, 3-dr Coupé, 98-06 / *00-06

*North America

480R
754

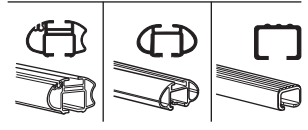
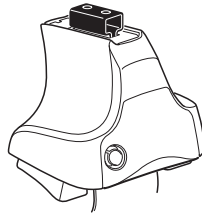

480

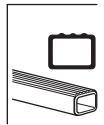
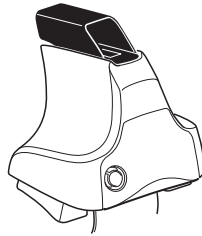

750

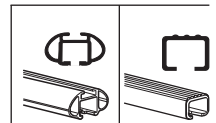
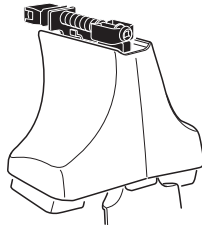

x2 x2 x2 x4	x2	x2 x2 x4 x4	x2 x2	x2

Kit

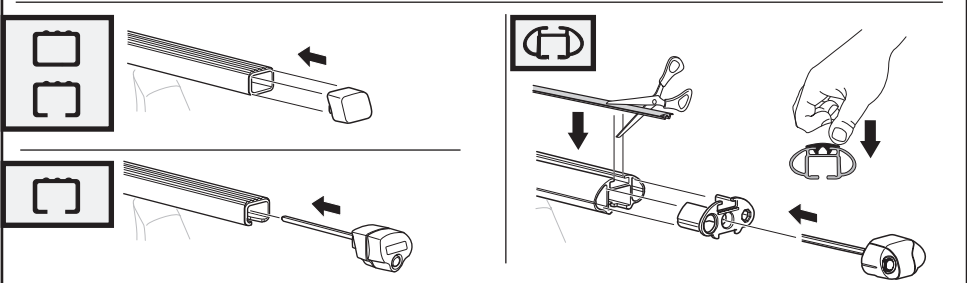
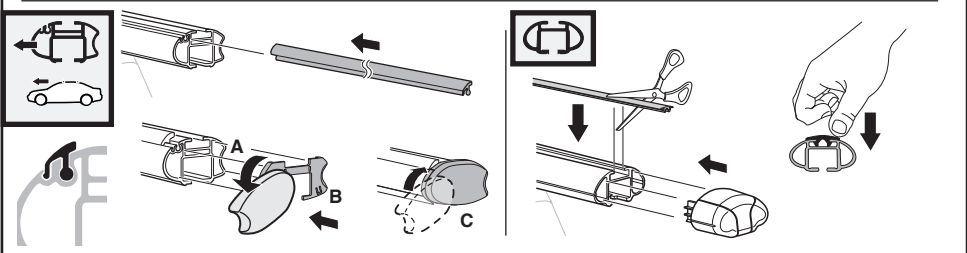
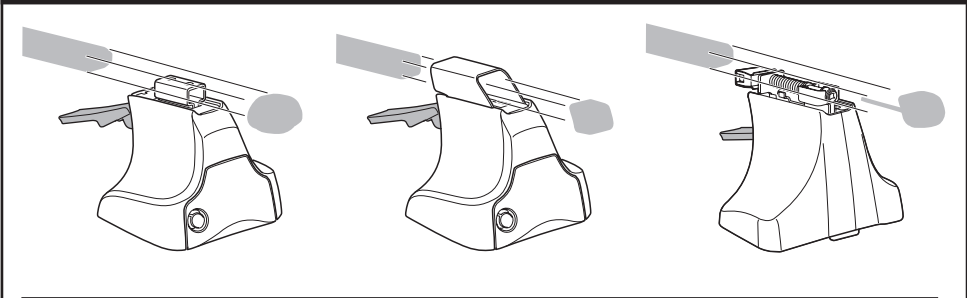
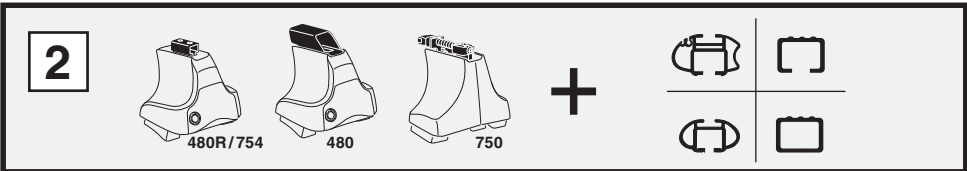
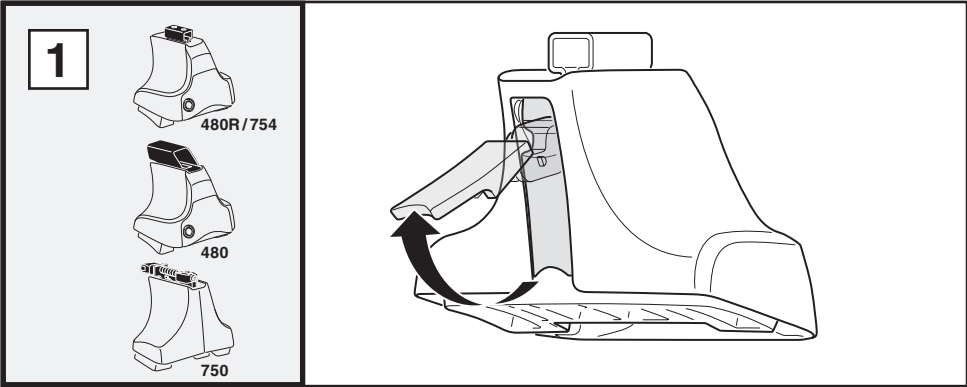

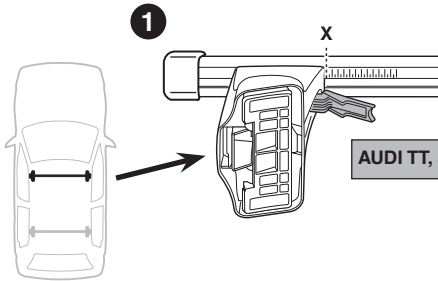
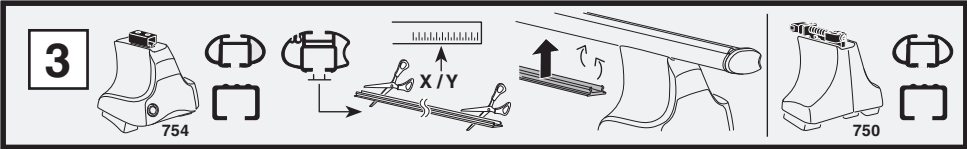

	X
AUDI TT, 3-dr Coupé, 98-06 / *00-06	40

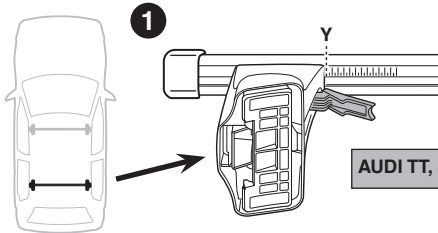

	Y
AUDI TT, 3-dr Coupé, 98-06 / *00-06	40,5

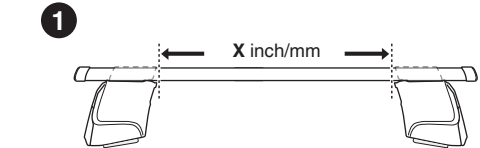
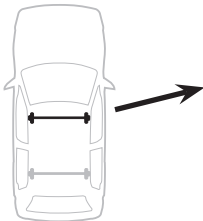
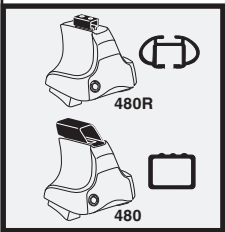

	X inch	X mm
AUDI TT, 3-dr Coupé, 98-06 / *00-06	41 ³ / ₈ "	1051 mm

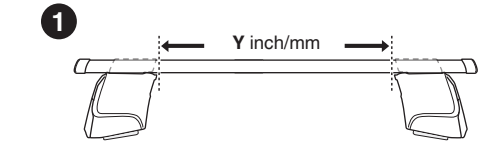
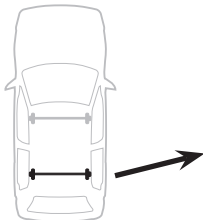

	Y inch	Y mm
AUDI TT, 3-dr Coupé, 98-06 / *00-06	41 ⁵ / ₈ "	1056 mm



4

AUDI TT, 3-dr Coupé, 98-06 / *00-06

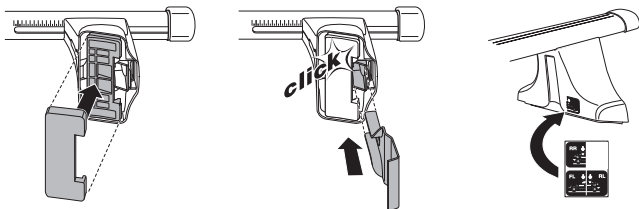
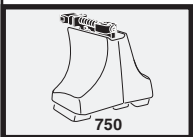
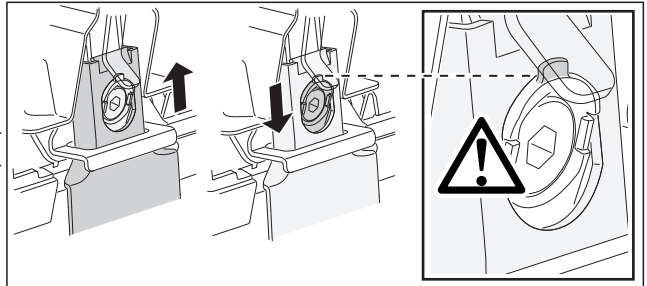
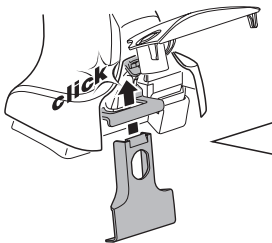
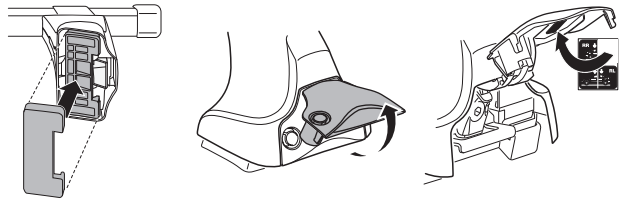
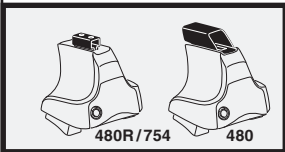
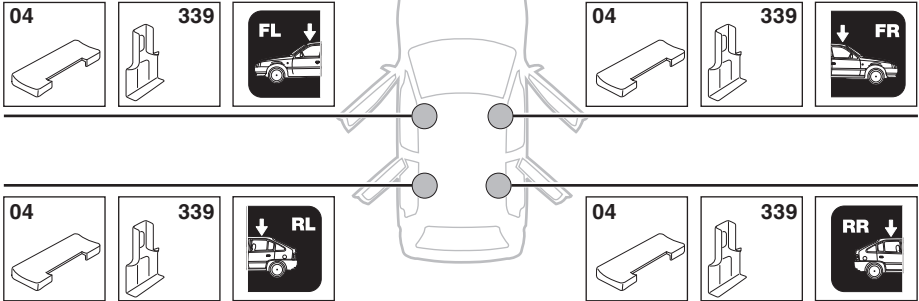

5

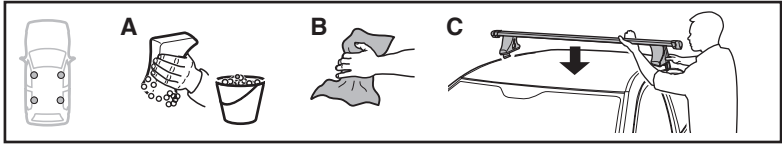

	X mm	Y mm	X inch	Y inch
AUDI TT, 3-dr Coupé, 98-06 / *00-06	90 mm	620 mm	3 1/2 "	24 3/8 "

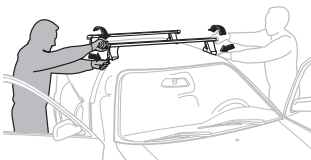
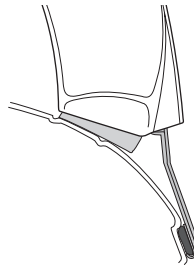
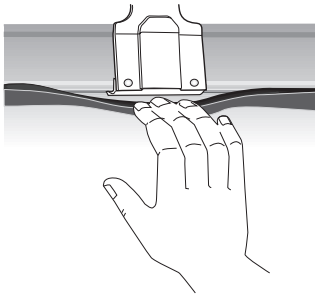
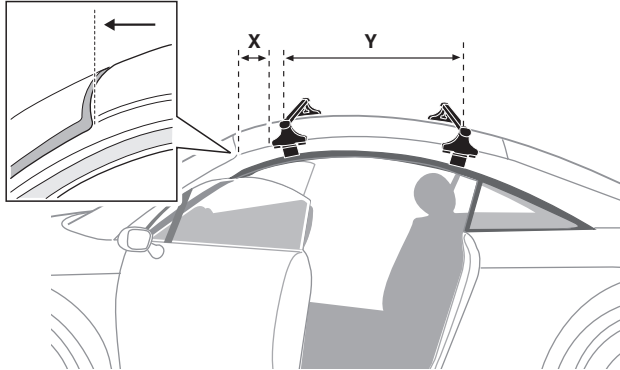

- GB/US** Tighten alternately
D Die Schrauben abwechselnd anziehen
F Serrer alternativement chaque côté
NL Afwisselend aan de linker- en de rechterkant aandraaien
I Alternare il serraggio delle viti
E Apretar alternativamente
PT Aperte alternadamente
S Dra åt växelvis
FIN Kierrä vuorotellen
EST Pinguldage vaheldumisi
LAT Pievelciot pamišus
LIT Užsukinėkite pakaitomis
PL Śruby dokręcaj naprzemiennie
RU Затягивайте попеременно

- CZ** Pokrétla bagazníka dokręcaj dokręcaj naprzemiennie.
SK Doťahujte striedavo
SLO Privijajte izmenično.
HR Naizmjenično zategnite
HU Egymástól függetlenül szorítandó
GR Σφιγγείτε εναλλάξ
TR Dönüşümlü sıkın

中文 交替拧紧

한국어 번갈아 가며 조이십시오.

日本語 交互に締め付けてください。

ไทย ชั้้นในแบบสลับ

6



480R/754



480

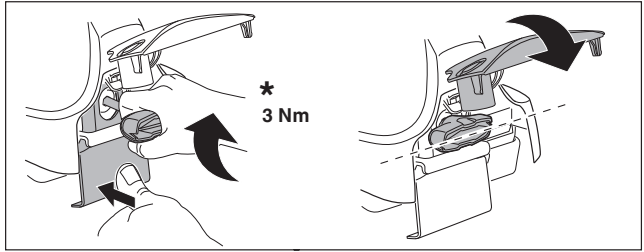
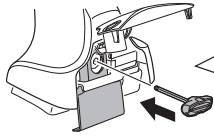

*
3 Nm

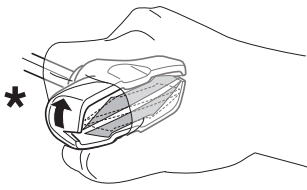

*

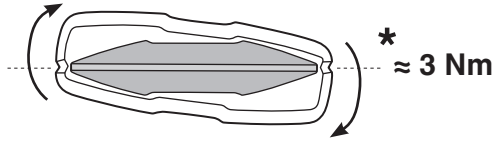

*
≈ 3 Nm

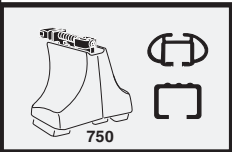
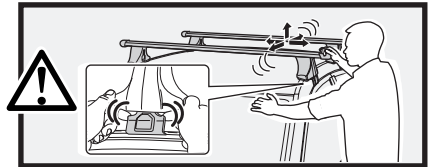

750

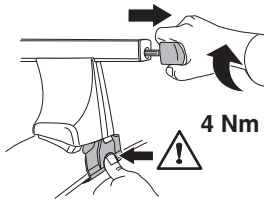

4 Nm

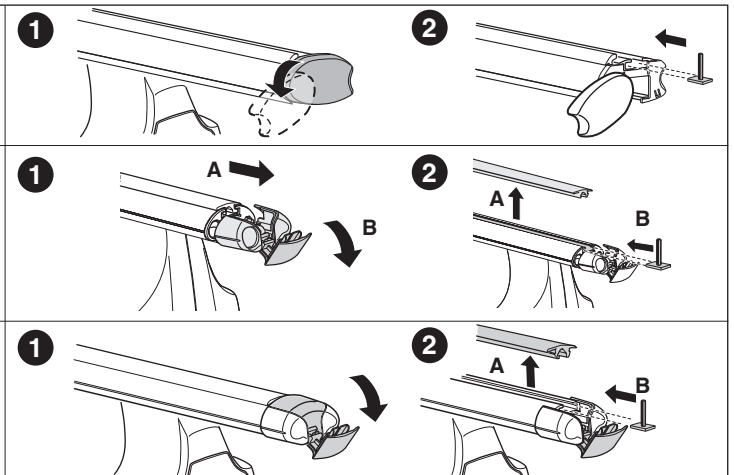
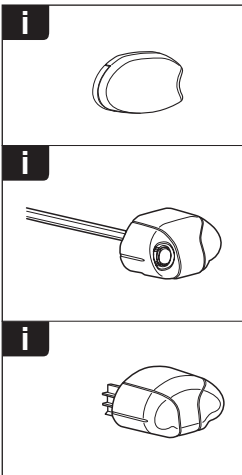
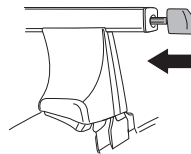

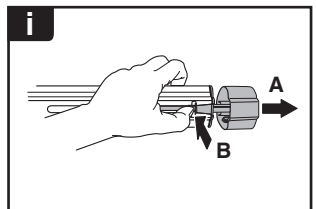
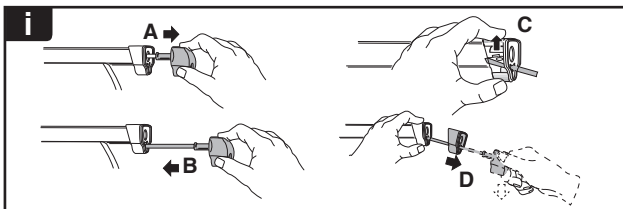
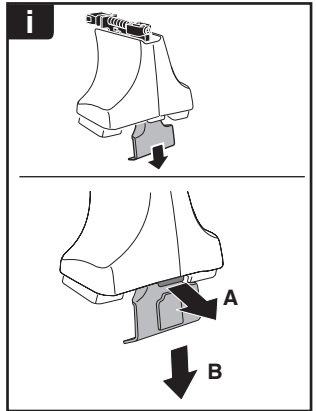
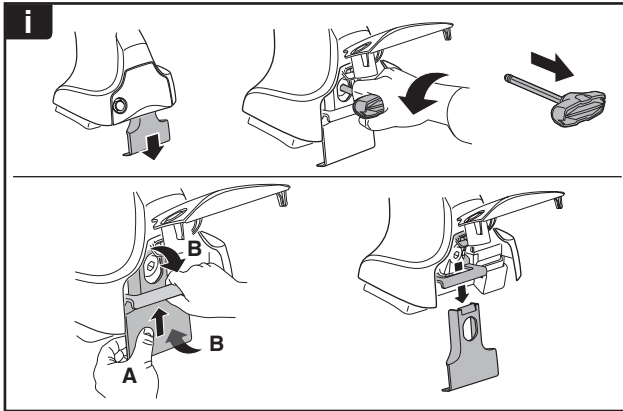
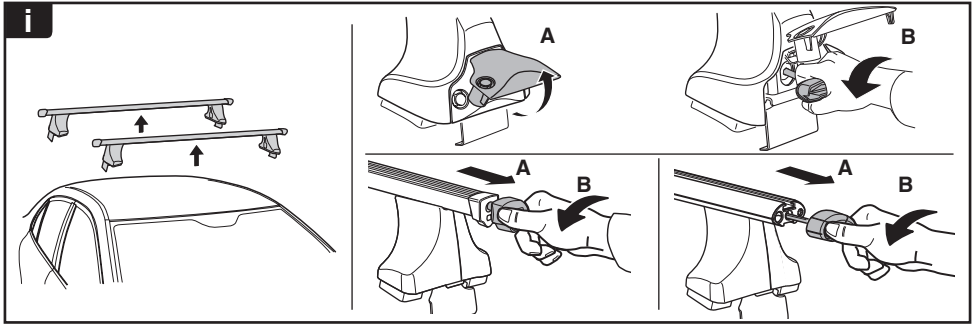

THULE
SWEDEN
**ONE
KEY
SYSTEM**

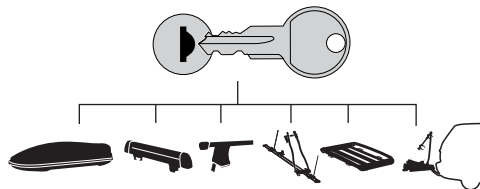

		(x4)
		(x6)
		(x8)
NA		(x10)
EUR		(x12)
ASIA		(x12)

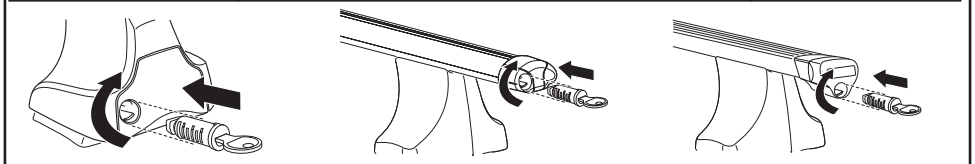

WW ▶ Thule Sweden AB, Box 69, 330 33 Hillerstorp, SWEDEN
NA ▶ Thule Inc., 42 Silvermine Road, Seymour, Connecticut 06483, USA

info@thule.com
customer.service@thule.com

www.thule.com