

Kit 3035

- CITROËN C8**, 5-dr MPV, 02–
- CITROËN Evasion**, 5-dr MPV, 94-01
- FIAT Ulyssé**, 5-dr MPV, 94-01, 02–
- LANCIA Phedra**, 5-dr MPV, 02–
- LANCIA Zeta**, 5-dr MPV, 94-01
- PEUGEOT 806**, 5-dr MPV, 94-01
- PEUGEOT 807**, 5-dr MPV, 02–

This Kit is only for vehicles with T-profile.

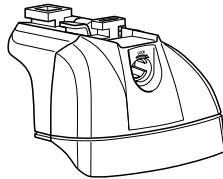

460R
753

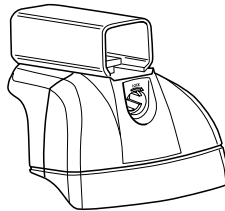
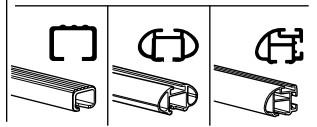

460

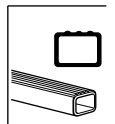

6 kg / 13 lbs + xx kg xx lbs =

Max. 100 kg
Max. 220 lbs

9 kg / 20 lbs + xx kg xx lbs =

Max. 150 kg
Max. 330 lbs

12 kg / 26 lbs + xx kg xx lbs =

Max. 200 kg
Max. 440 lbs

09 x 4

34 x 4

31307 x 8

30147 x 8

50094 x 4

30065 x 1

Kit

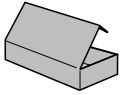

753

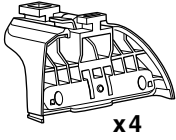

x4



x4



x4



x8

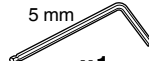

x1



x4



x1

460R

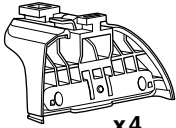

x4



x4



x4



x8

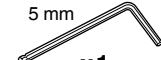

x1



x4

460

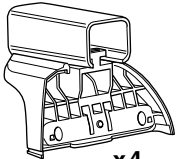

x4



x4



x4



x8

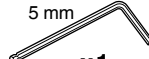

x1



x4

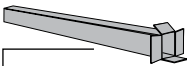

x2



x2

17 mm



x2

23 mm



x2

23 mm



x2



x2

17 mm



x2

23 mm

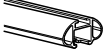

x2

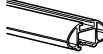

x2

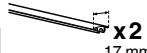

x2

25 mm



x2

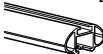

x2



x4

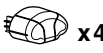

x4

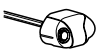

x4



x2



x2



x4



x4



x1

5 mm

1

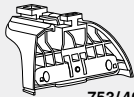

753/460R

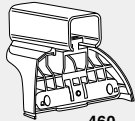

460

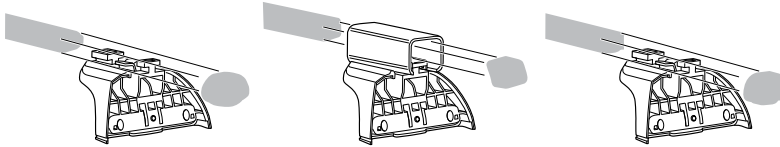

x4

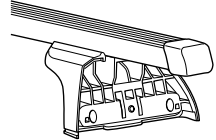
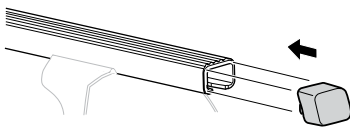

x4

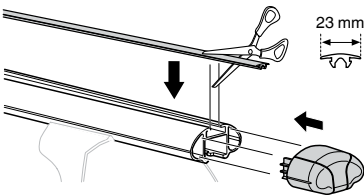

23 mm

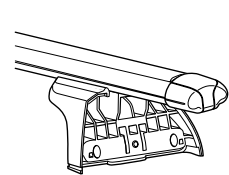
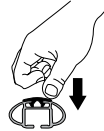

x4

x4

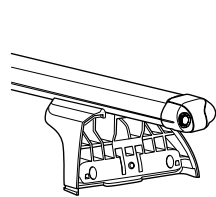
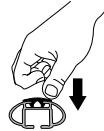
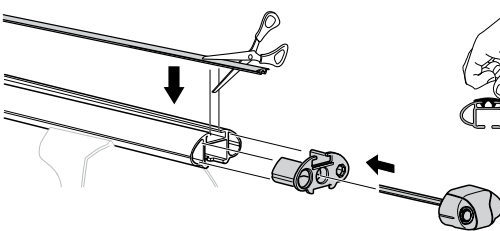

x4

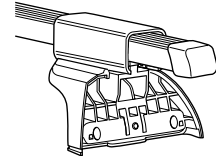
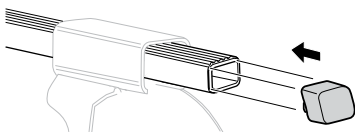

x2

x2

x4

x4

x1
5 mm

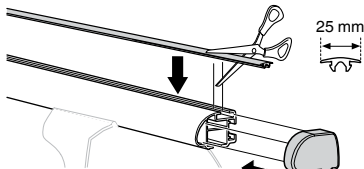

25 mm

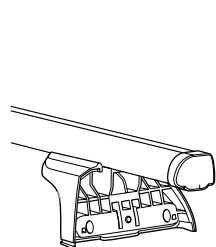
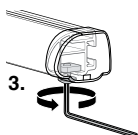
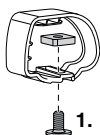
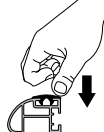

2

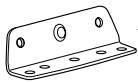

◀ 09 x 4



◀ 34 x 4

16 mm  x 8



x 1

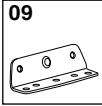

34

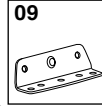
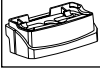

34

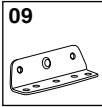
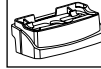

34

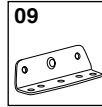
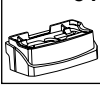

34

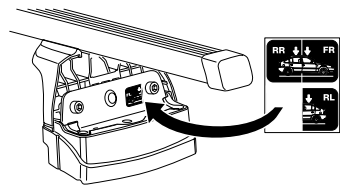
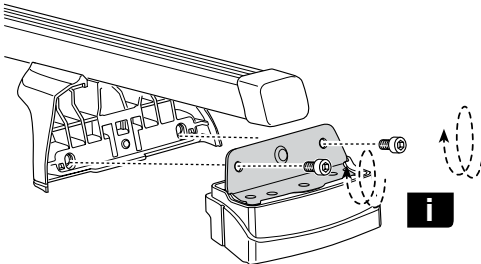
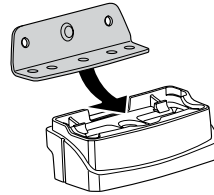
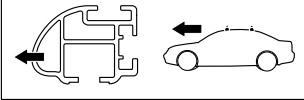

GB Only a few turns
D Nur wenige Umdrehungen
F Quelques tours uniquement
NL Slechts enkele slagen
I Solo qualche giro
E Sólo algunas vueltas
PT Noções básicas
S Endast några varv
FIN Vain muutama kierros

EST Ainult mõni pööre
LAT Tikai dažī apgriezieni
LIT Tik keli pasukimai
PL Wystarczy kilka obrotów
RU Достаточно нескольких оборотов
CZ Pouze několik otáček
SK Len niekoľko otáčok
SLO Le nekaj obratov

HR Samo nekoliko okreta
HU Csak néhány fordítás
GR Μόνο μερικές στροφές
TR Yalnız birkaç kez çevirm
中文 只有几个转向
한국어 두 세번만
日本語 数回転のみ
ไทย หมุนเพียงไม่กี่รอบ

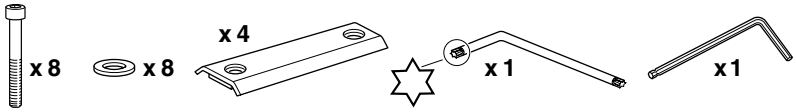
3

CITROËN C8, 5-dr MPV, 02-
CITROËN Evasion, 5-dr MPV, 94-01-
FIAT Ulyssé, 5-dr MPV, 94-01, 02-
LANCIA Phedra, 5-dr MPV, 02-
LANCIA Zeta, 5-dr MPV, 94-01-
PEUGEOT 807, 5-dr MPV, 02-

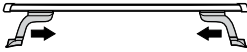
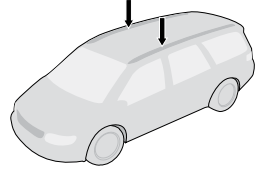
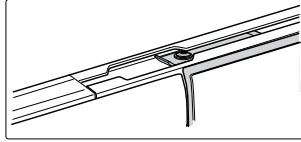
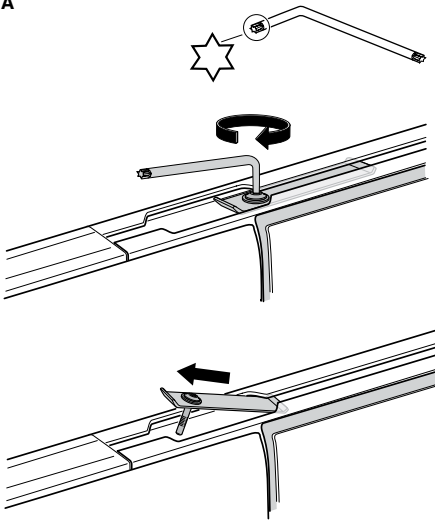
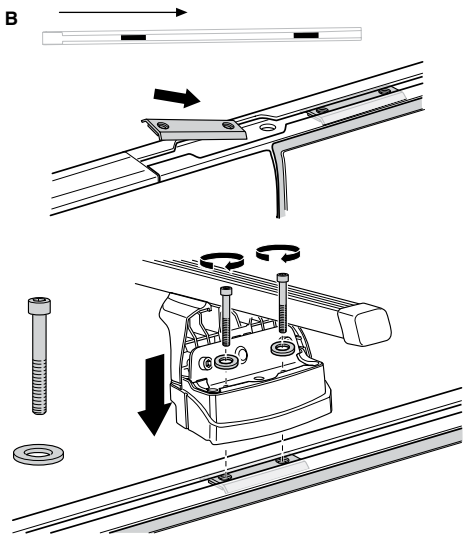
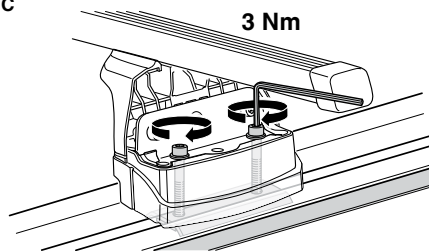
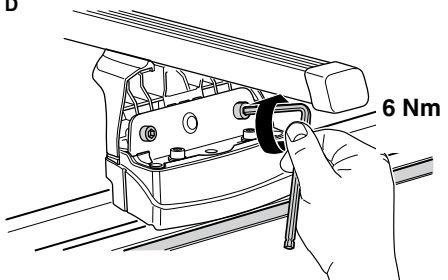
**A****B****C****D**

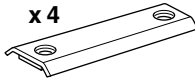
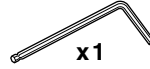
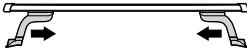
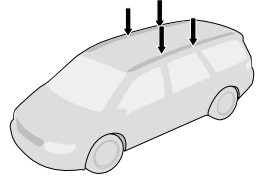
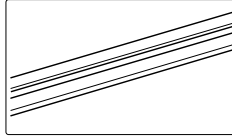
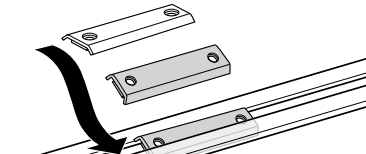
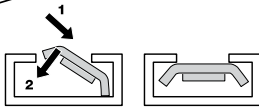
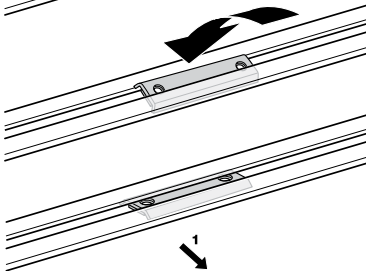
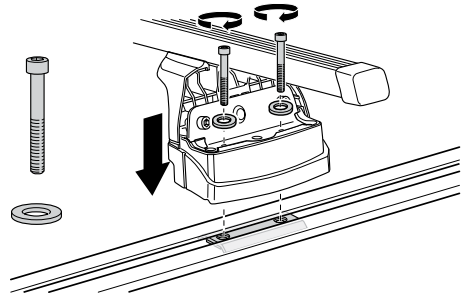
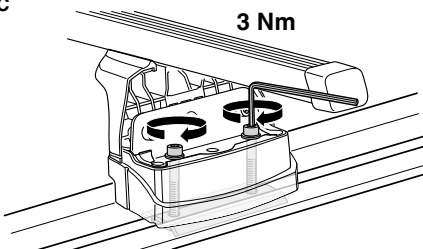
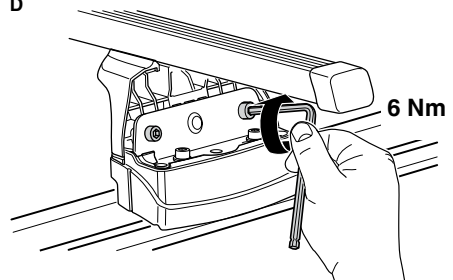
3**x 8****x 8****x 4****x 1****PEUGEOT 806**, 5-dr MPV, 94-01**A 1****2****B****C****3 Nm****D****6 Nm**

