











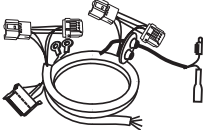





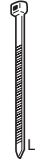

732573: Nissan Note E11 11/2005

A (1x)  7 pin	B (1x) 	C (1x) 	D (1x) 	E (1x) 	F (1x) 	colour chart
K (3x)  M5x35	L (3x)  M5	M (1x)  M6x10	N (1x)  M6	P (1x)  M6	Z (6x)  L = 100	
Q (1x) 	R (1x) 	S (1x) 	V (1x) 10 A 	W (1x) 	H (1x) 	J (2x)  L = 290

026-0000-0121 (basis 025-0000-0075)

- | | |
|--|--|
| NL Algemene richtlijnen voor montage | ES Directorios generales para la asamblea |
| DK Almene oplysninger | I Istruzioni generali |
| D Allgemeine Hinweise zur Montage-Erleichterung | GR Γενικές οδηγίες για τη συνέλευση |
| FR Directives générales pour faciliter le montage | HUN Használati útmutató |
| S Allmänna Instruktioner | SK Uživatelská príručka |
| GB General instructions | PL Ogólne polecenia |
| SF Yleisiä ohjeita | PU Diretrizes orientadoras gerais para o conjunto |

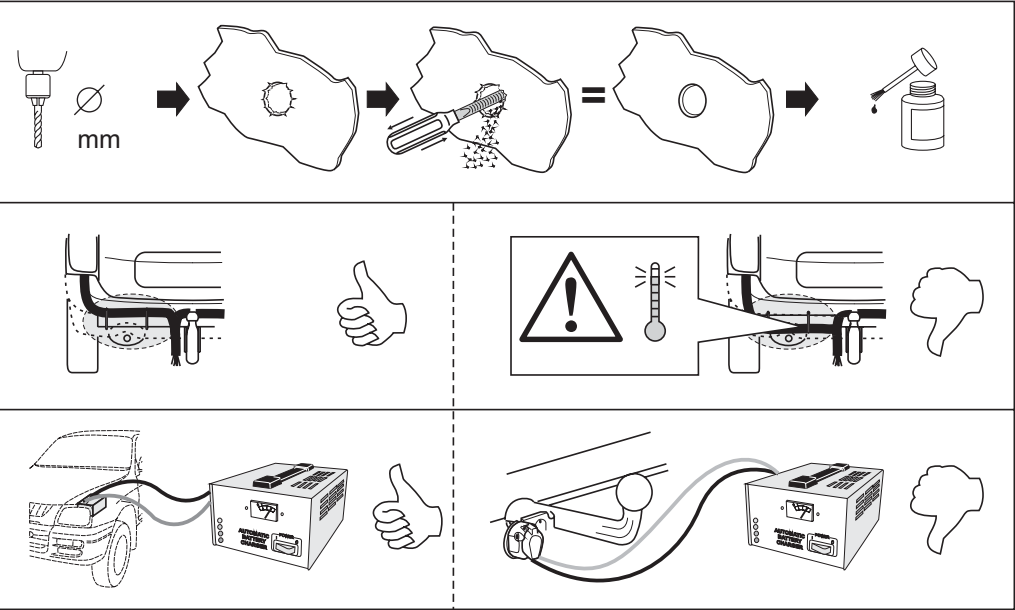

ROUTING

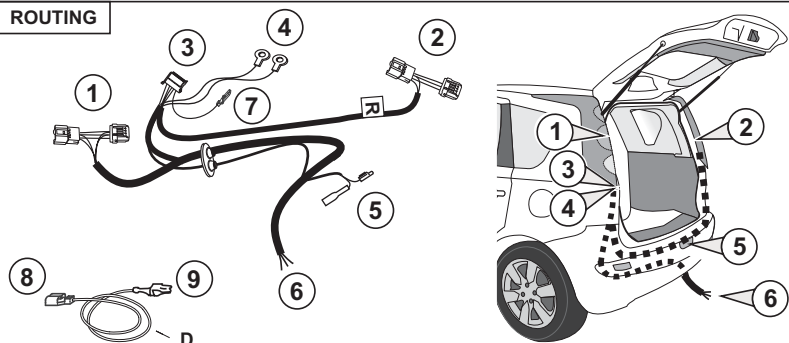
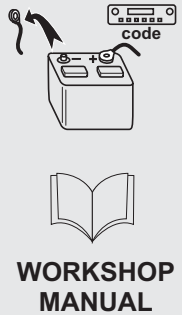

ATTENTION: MODELS 12/2006 -

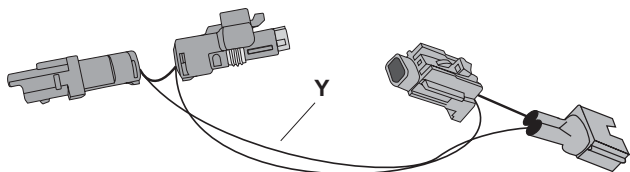

BRINK PARTNUMBER: 732579

1

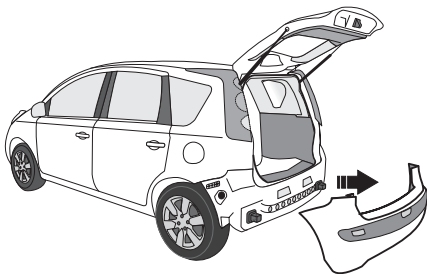

2

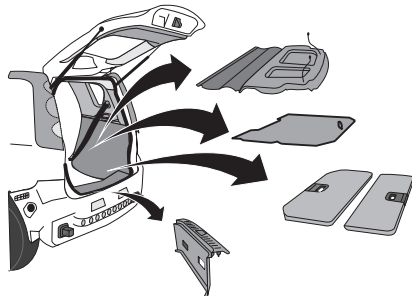

3

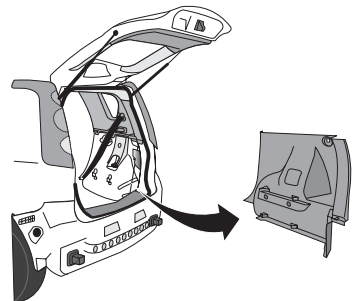

4

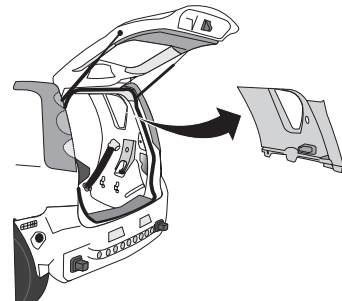

16 **TEST**

17

Tester lamp

Tester L.E.D.

18

MANUAL

OWNERS MANUAL

5

6

7

8

9

ATTENTION

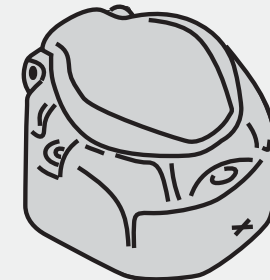

Ø 5,5 mm

INFO

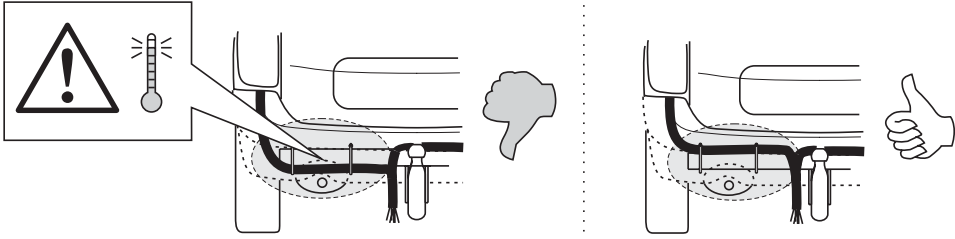

10

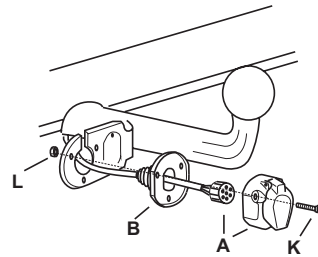
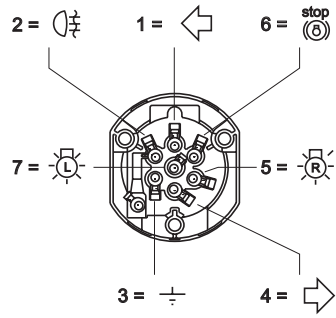

COLOUR CHART G

11

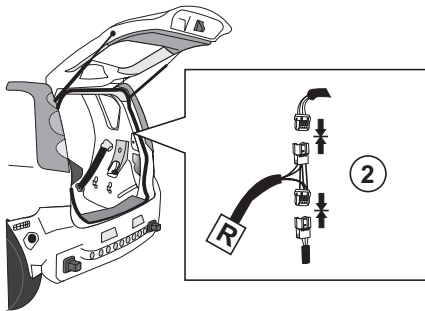

12

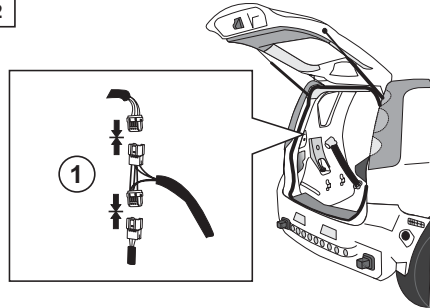

13

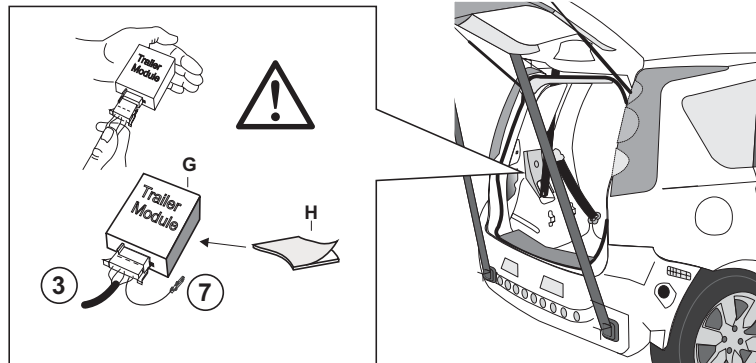

14

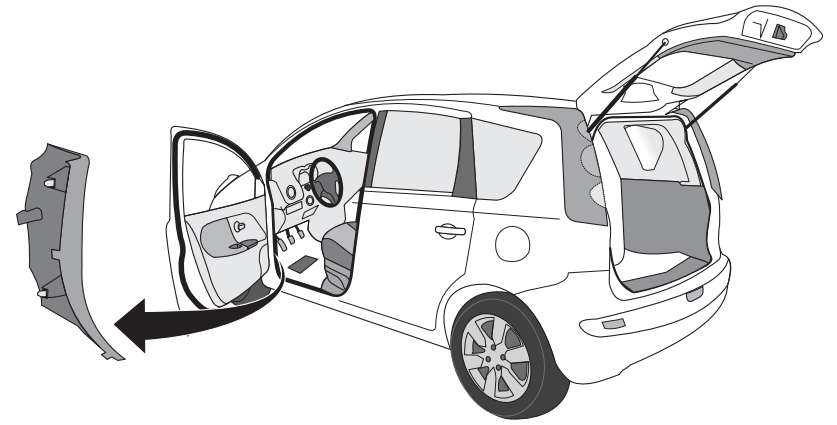

15

