

# Kit 1522

CHEVROLET Silverado / Silverado Classic, 2-dr Standard Cab, 99-07

CHEVROLET Silverado / Silverado Classic, 4-dr Extended Cab, 99-07

CHEVROLET Silverado / Silverado Classic, 4-dr Crew Cab, 99-07

GMC Sierra / Sierra Classic, 2-dr Standard Cab, 99-07

GMC Sierra / Sierra Classic, 4-dr Extended Cab, 99-07

GMC Sierra / Sierra Classic, 4-dr Crew Cab, 99-07

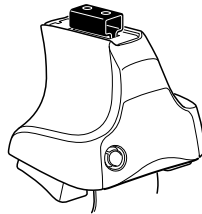

**754** Rapid System  
**480R** Rapid Traverse (North America)

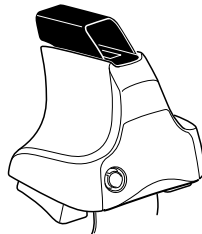
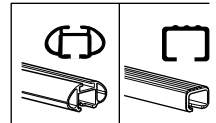

**480** Traverse (North America)

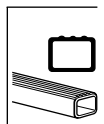



1



2



754 Rapid System  
480R Rapid Traverse  
(North America)



x4

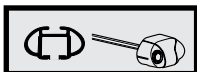

x4

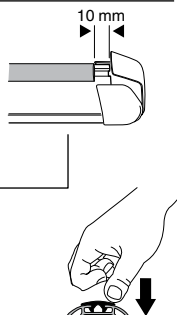
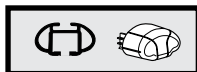

x4



480 Traverse  
(North America)



x4

**3**



**754** Rapid System



**X**

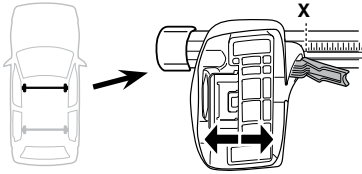

CHEVROLET Silverado / Silverado Classic, 2-dr Standard Cab, 99-07	51
CHEVROLET Silverado / Silverado Classic, 4-dr Extended Cab, 99-07	51
CHEVROLET Silverado / Silverado Classic, 4-dr Crew Cab, 99-07	51
GMC Sierra / Sierra Classic, 2-dr Standard Cab, 99-07	51
GMC Sierra / Sierra Classic, 4-dr Extended Cab, 99-07	51
GMC Sierra / Sierra Classic, 4-dr Crew Cab, 99-07	51

**Y**

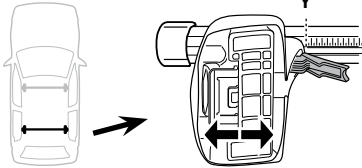

CHEVROLET Silverado / Silverado Classic, 2-dr Standard Cab, 99-07	50,5
CHEVROLET Silverado / Silverado Classic, 4-dr Extended Cab, 99-07	50,5
CHEVROLET Silverado / Silverado Classic, 4-dr Crew Cab, 99-07	50,5
GMC Sierra / Sierra Classic, 2-dr Standard Cab, 99-07	50,5
GMC Sierra / Sierra Classic, 4-dr Extended Cab, 99-07	50,5
GMC Sierra / Sierra Classic, 4-dr Crew Cab, 99-07	50,5

**3**



**480R** Rapid Traverse



**480** Traverse



**(North America)**

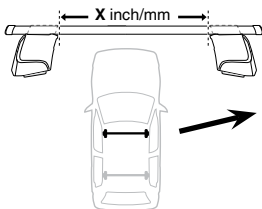

	X inch	X mm
CHEVROLET Silverado / Silverado Classic, 2-dr Standard Cab, 99-07	45 3/4"	1161 mm
CHEVROLET Silverado / Silverado Classic, 4-dr Extended Cab, 99-07	45 3/4"	1161 mm
CHEVROLET Silverado / Silverado Classic, 4-dr Crew Cab, 99-07	45 3/4"	1161 mm
GMC Sierra / Sierra Classic, 2-dr Standard Cab, 99-07	45 3/4"	1161 mm
GMC Sierra / Sierra Classic, 4-dr Extended Cab, 99-07	45 3/4"	1161 mm
GMC Sierra / Sierra Classic, 4-dr Crew Cab, 99-07	45 3/4"	1161 mm

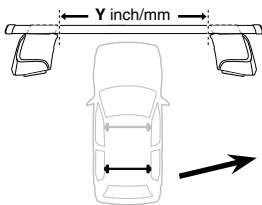

	Y inch	Y mm
CHEVROLET Silverado / Silverado Classic, 2-dr Standard Cab, 99-07	45 1/2"	1156 mm
CHEVROLET Silverado / Silverado Classic, 4-dr Extended Cab, 99-07	45 1/2"	1156 mm
CHEVROLET Silverado / Silverado Classic, 4-dr Crew Cab, 99-07	45 1/2"	1156 mm
GMC Sierra / Sierra Classic, 2-dr Standard Cab, 99-07	45 1/2"	1156 mm
GMC Sierra / Sierra Classic, 4-dr Extended Cab, 99-07	45 1/2"	1156 mm
GMC Sierra / Sierra Classic, 4-dr Crew Cab, 99-07	45 1/2"	1156 mm

**4**

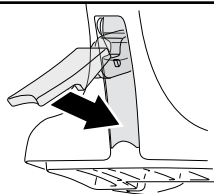

**5**

**CHEVROLET Silverado / Silverado Classic, 2-dr Standard Cab, 99-07**  
**GMC Sierra / Sierra Classic, 2-dr Standard Cab, 99-07**

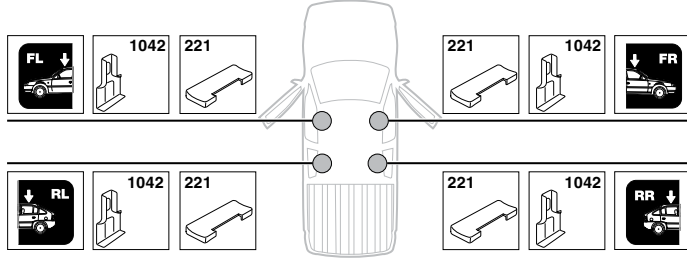

**CHEVROLET Silverado / Silverado Classic, 4-dr Extended Cab, 99-07**  
**CHEVROLET Silverado / Silverado Classic, 4-dr Crew Cab, 99-07**  
**GMC Sierra / Sierra Classic, 4-dr Extended Cab, 99-07**  
**GMC Sierra / Sierra Classic, 4-dr Crew Cab, 99-07**

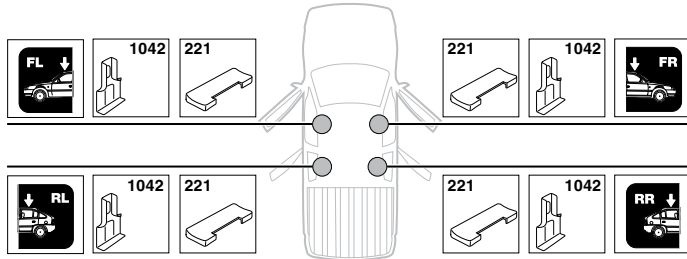
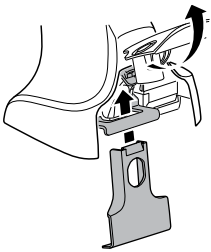
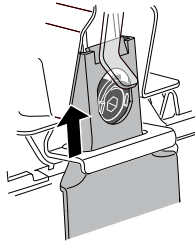
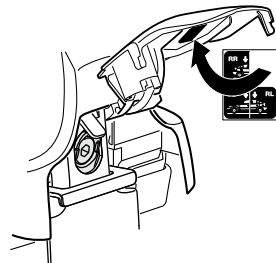
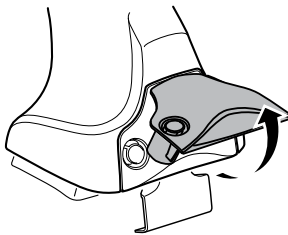
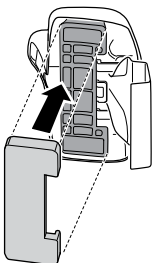
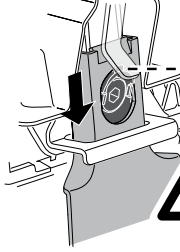
**A****B****C**

6

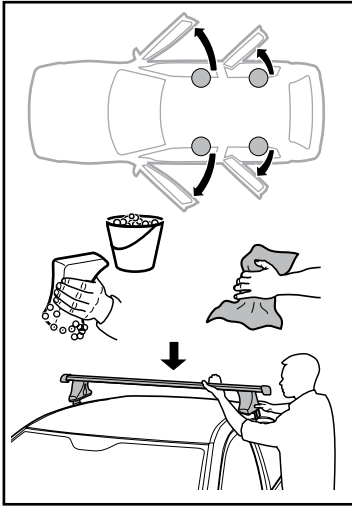

i

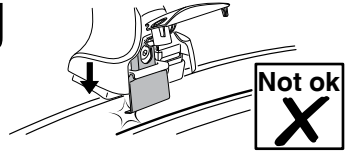

A

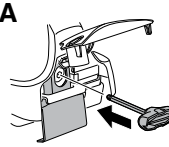

B

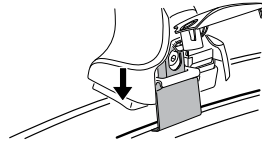
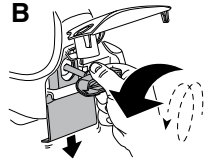

ok

	X mm	Y mm	X inch	Y inch
CHEVROLET Silverado / Silverado Classic, 2-dr Standard Cab, 99-07	255 mm	305 mm	10"	12"
CHEVROLET Silverado / Silverado Classic, 4-dr Extended Cab, 99-07	280 mm	800 mm	11"	31 1/2"
CHEVROLET Silverado / Silverado Classic, 4-dr Crew Cab, 99-07	280 mm	800 mm	11"	31 1/2"
GMC Sierra / Sierra Classic, 2-dr Standard Cab, 99-07	255 mm	305 mm	10"	12"
GMC Sierra / Sierra Classic, 4-dr Extended Cab, 99-07	280 mm	800 mm	11"	31 1/2"
GMC Sierra / Sierra Classic, 4-dr Crew Cab, 99-07	280 mm	800 mm	11"	31 1/2"

**CHEVROLET Silverado / Silverado Classic, 2-dr Standard Cab, 99-07**

**GMC Sierra / Sierra Classic, 2-dr Standard Cab, 99-07**

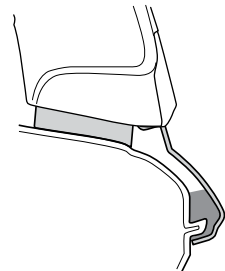
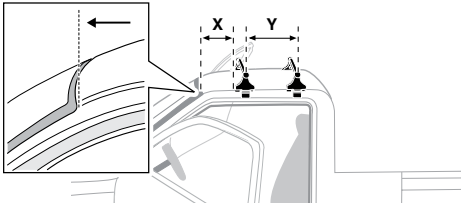

**CHEVROLET Silverado / Silverado Classic, 4-dr Extended Cab, 99-07**

**CHEVROLET Silverado / Silverado Classic, 4-dr Crew Cab, 99-07**

**GMC Sierra / Sierra Classic, 4-dr Extended Cab, 99-07**

**GMC Sierra / Sierra Classic, 4-dr Crew Cab, 99-07**

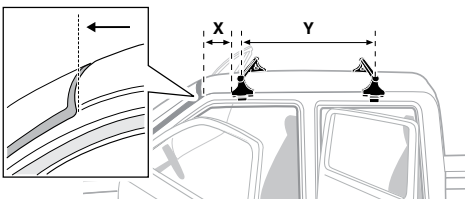

7



<b>GB/US</b>	Tighten alternately
<b>D</b>	Die Schrauben abwechselnd anziehen
<b>F</b>	Serrer alternativement chaque côté
<b>NL</b>	Afwisselend aan de linker- en de rechterkant aandraaien
<b>I</b>	Alternare il serraggio delle viti
<b>E</b>	Apertar alternativamente
<b>PT</b>	Aperte alternadamente
<b>S</b>	Dra åt växelvis
<b>FIN</b>	Kierrä vuorotellen
<b>EST</b>	Pinguldage vaheldumisi
<b>LAT</b>	Pielveiciet pamišus
<b>LIT</b>	Užsukinėkite pakaitomis
<b>PL</b>	Śruby dokręcaj naprzemiennie
<b>RU</b>	Загряивайте попеременно

<b>CZ</b>	Pokręřta багаžnika dokręcaj naprzemiennie.
<b>SK</b>	Dofahajte striedavo
<b>SLO</b>	Privijajte izmenično.
<b>HR</b>	Naizmjenično zategnite
<b>HU</b>	Egymástól függetlenül szorítandó
<b>GR</b>	Σφιγίγες ενολάξ
<b>TR</b>	Dönüşümlü sıkın

**中文** 交替拧紧

**한국어** 번갈아 가며 조이십시오.

**日本語** 交互に締め付けてください。

**ไทย** ชันในแบบสลับ

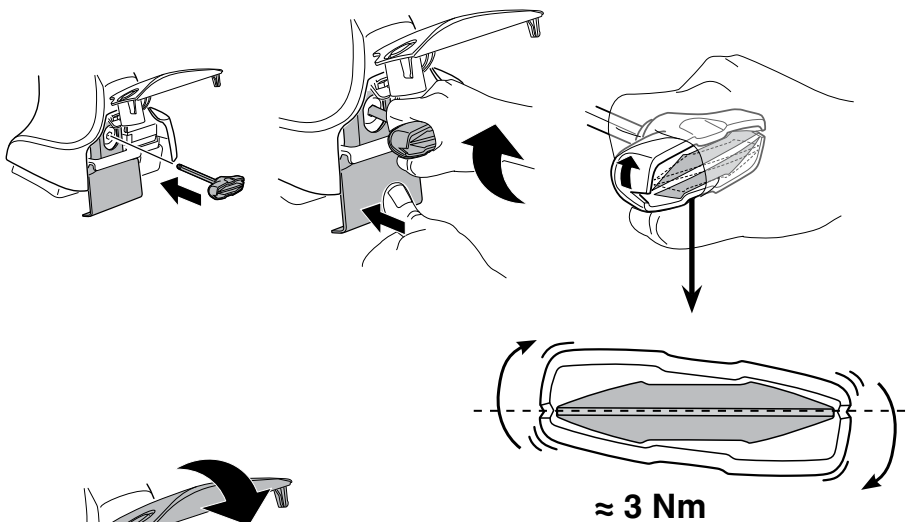

≈ 3 Nm

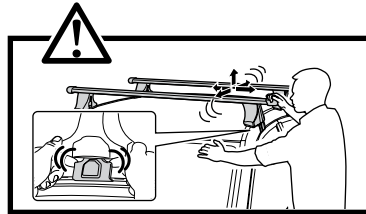

8

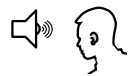
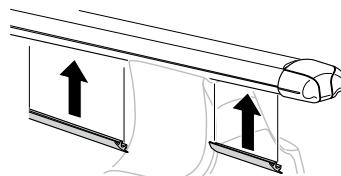
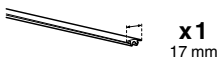

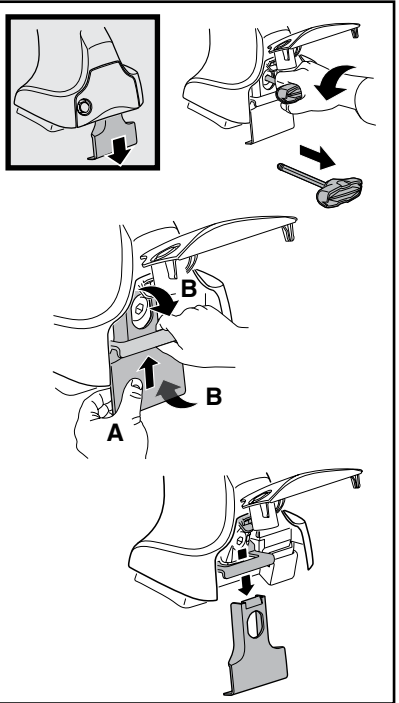
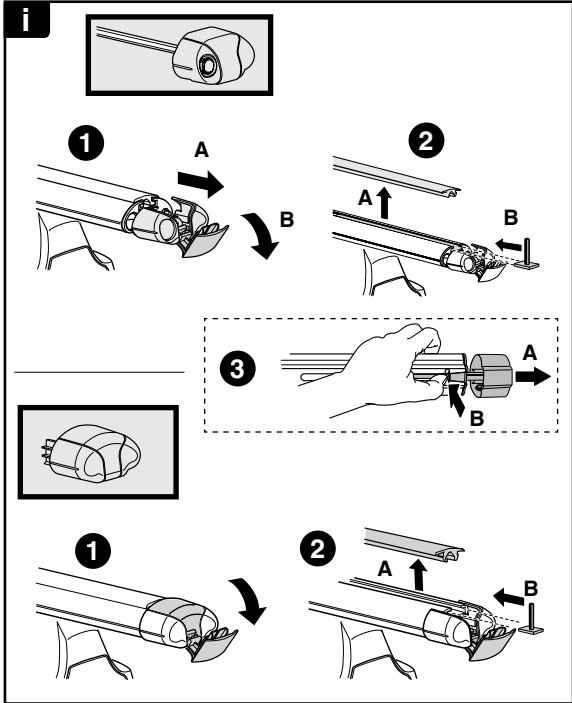

**THULE**  
SWEDEN  
**ONE  
KEY  
SYSTEM**

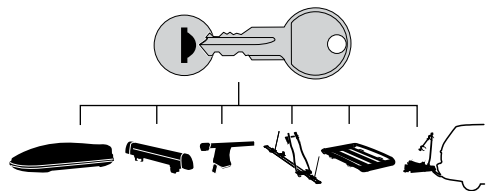

		(x4)
		(x6)
		(x8)
NA		(x10)
EUR		(x12)
ASIA		



WW ▶ Thule Sweden AB, Box 69, 330 33 Hillerstorp, SWEDEN  
NA ▶ Thule Inc., 42 Silvermine Road, Seymour, Connecticut 06483, USA

info@thule.com  
customer.service@thule.com

www.thule.com