

Thule Rapid System Kit 1409

> Instructions

MITSUBISHI Outlander II, 5-dr SUV, 06-12

MITSUBISHI Outlander, 5-dr SUV, *07-13

*North America

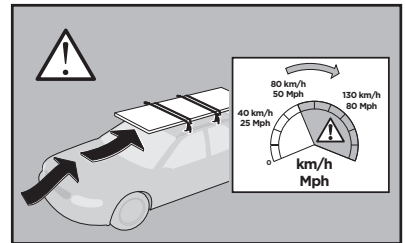
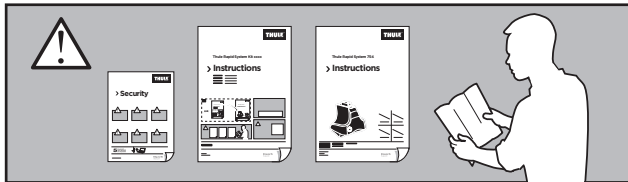
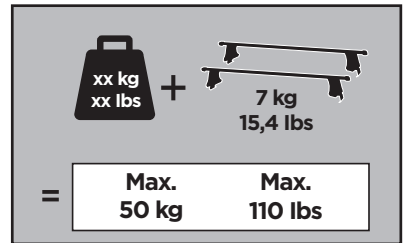
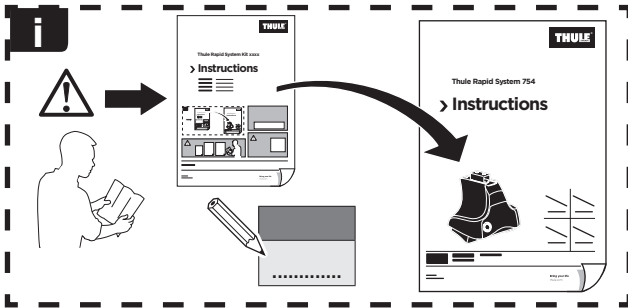

ISO 11154-E



239 x4

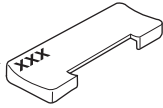

791 x2



792 x2



x1

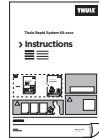

x1

1

	X (scale)	X (mm)	X (inch)
MITSUBISHI Outlander II , 5-dr SUV, 06-12	48	1131	44 1/2
MITSUBISHI Outlander , 5-dr SUV, *07-13	48	1131	44 1/2

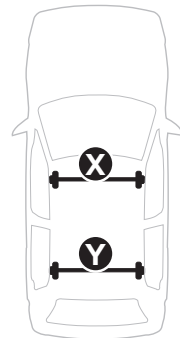
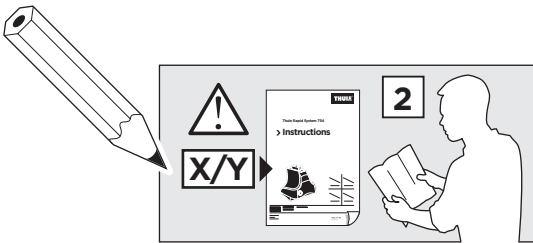

	Y (scale)	Y (mm)	Y (inch)
MITSUBISHI Outlander II , 5-dr SUV, 06-12	43,5	1086	42 3/4
MITSUBISHI Outlander , 5-dr SUV, *07-13	43,5	1086	42 3/4

2

MITSUBISHI Outlander II, 5-dr SUV, 06-12

MITSUBISHI Outlander, 5-dr SUV, *07-13

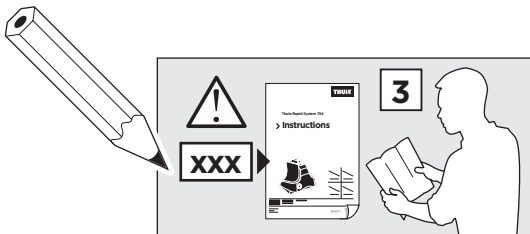
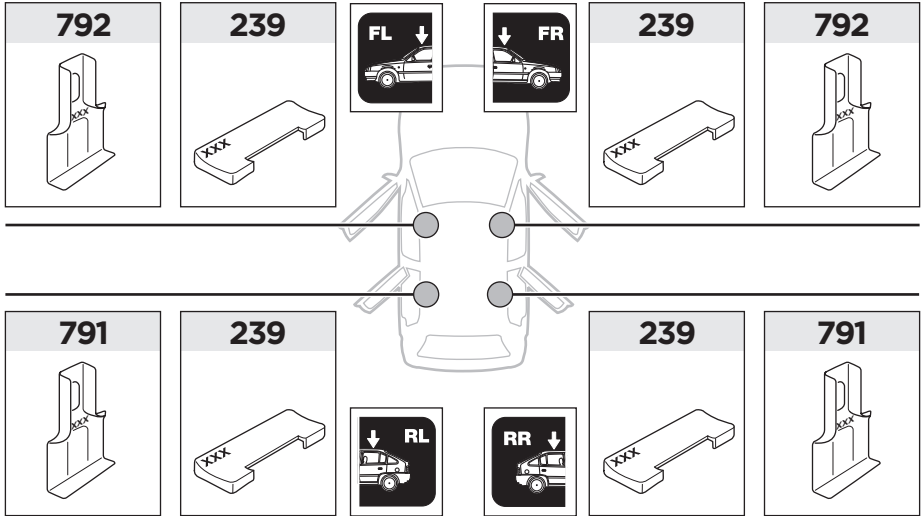

3

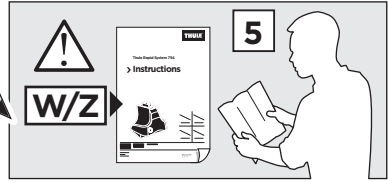

	W (mm)	Z (mm)	W (inch)	Z (inch)
MITSUBISHI Outlander II , 5-dr SUV, 06-12	440	800	17 ³/₈	31 ¹/₂
MITSUBISHI Outlander , 5-dr SUV, *07-13	440	800	17 ³/₈	31 ¹/₂

