



Thule XT Kit 3022

> Instructions

VOLKSWAGEN Caddy, 4/5-dr MPV, 04-15, 16-
VOLKSWAGEN Caddy, 4/5-dr Van, 04-15, 16-
VOLKSWAGEN Caddy Maxi, 4/5-dr MPV, 08-15, 16-
VOLKSWAGEN Caddy Maxi, 4/5-dr Van, 08-15, 16-

This kit is only for vehicles with fixpoint mounting.

The diagram illustrates the installation and weight limits for the Thule XT Kit 3022. It is divided into several sections:

- Weight Limits:** Two equations show the maximum weight capacity based on the vehicle's weight (xx kg / xx lbs) and the kit's weight (6 kg / 13 lbs and 9 kg / 20 lbs).
Equation 1: $xx \text{ kg } xx \text{ lbs} + 6 \text{ kg } / 13 \text{ lbs} = \text{Max. } 100 \text{ kg } / 220 \text{ lbs}$
Equation 2: $xx \text{ kg } xx \text{ lbs} + 9 \text{ kg } / 20 \text{ lbs} = \text{Max. } 150 \text{ kg } / 330 \text{ lbs}$
- Documentation:** A silhouette of a person reading instructions is shown next to icons for the 751 FootPack, 753 FootPack, and Security instructions.
- Mounting:** A diagram shows the kit being mounted on a vehicle roof with three fixpoints.
- Speedometer:** A speedometer diagram shows a warning zone between 40 km/h (25 Mph) and 80 km/h (50 Mph), with a maximum speed limit of 130 km/h (80 Mph).

ISO 11154-E

183022

C.20191127
509-3022-05

Bring your life
thule.com

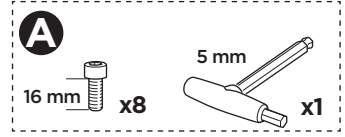
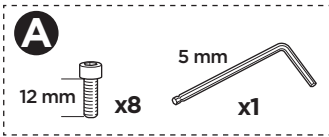

21 x4

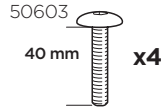

50603 40 mm x4



51346 x4



07 x4

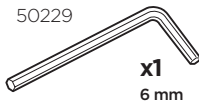

50229 x1 6 mm



x1

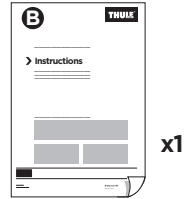

x1

1

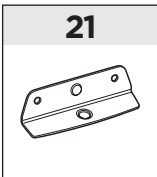
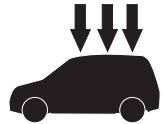
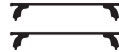

21

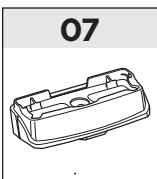

07

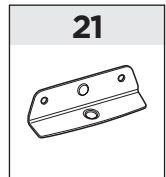
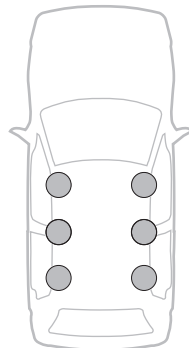

21

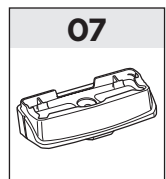

07

1

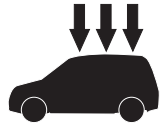

751
FootPack

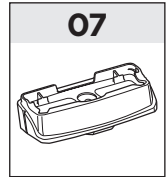
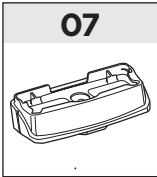
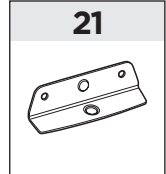
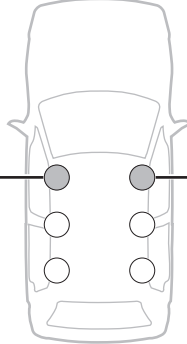
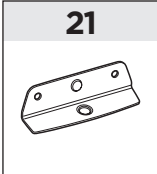

753
FootPack

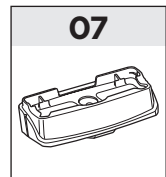
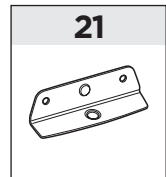
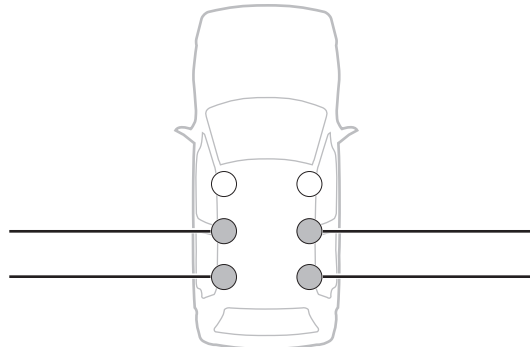
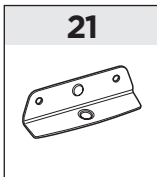

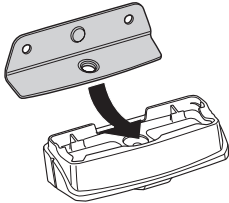
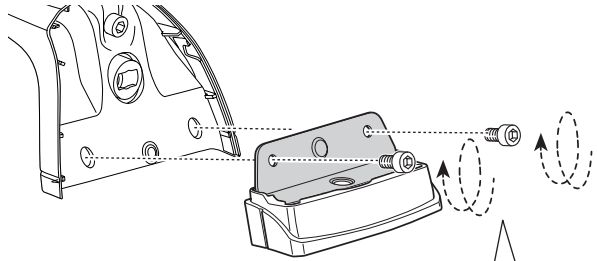
2**A****B**

EN Only a few turns
DE Nur wenige Umdrehungen
FR Quelques tours uniquement
NL Slechts enkele slagen
IT Solo qualche giro
ES Sólo algunas vueltas
PT Apenas algumas voltas
SV Endast några varv
DK Kun nogle få omgange
NO Bare noen få omdreinger
FI Vain muutama kierros

ET Ainult mõni pööre
LV Tikai daži apgriezieni
LT Tik keli pasukimai
PL Wystarczy kilka obrotów
RU Только несколько оборотов
UK Лише декілька обертів
BG Само няколко завъртания
CS Pouze několik otáček
SK Len niekoľko otáčok
SL Le nekaj obratov
HR/BIH Samo nekoliko okreta

RO Doar câteva rotiri
HU Csak néhány fordítás
EL Μόνο λίγες περιστροφές
TR Yalnızca birkaç tur

بعض دورات فقط **AR**
 רק מספר סיבובים **HE**

ZH 仅几圈
JA 2～3回転のみ
KO 몇 번만 돌리면 됨
TH เพียงสองสามรอบ

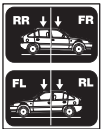
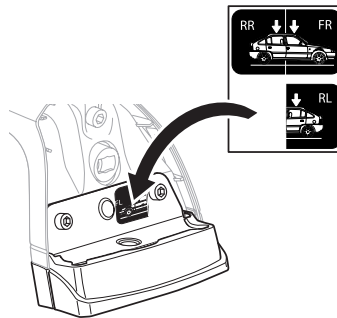
3**x1**

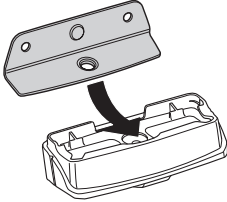
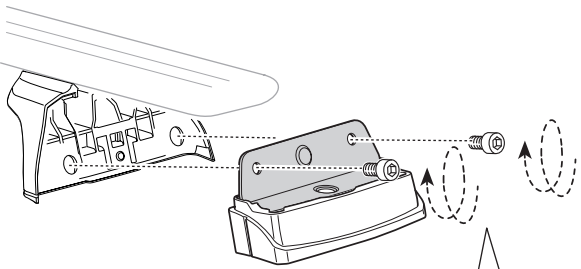
2**753**
FootPack**A****B**

EN Only a few turns
DE Nur wenige Umdrehungen
FR Quelques tours uniquement
NL Slechts enkele slagen
IT Solo qualche giro
ES Sólo algunas vueltas
PT Apenas algumas voltas
SV Endast några varv
DK Kun nogle få omgange
NO Bare noen få omdreinger
FI Vain muutama kierros

ET Ainult mõni pööre
LV Tikai dažī apgriezieni
LT Tik keli pasukimai
PL Wystarczy kilka obrotów
RU Только несколько оборотов
UK Лише декілька обертів
BG Само няколко завъртания
CS Pouze několik otáček
SK Len niekoľko otáčok
SL Le nekaj obratov
HR/BIH Samo nekoliko okreta

RO Doar câteva rotiri
HU Csak néhány fordítás
EL Μόνο λίγες περιστροφές
TR Yalnızca birkaç tur

بعض دورات فقط **AR**
 רק מספר סיבובים **HE**

ZH 仅几圈
JA 2～3回転のみ
KO 몇 번만 돌리면 됨
TH เพียงสองสามรอบ

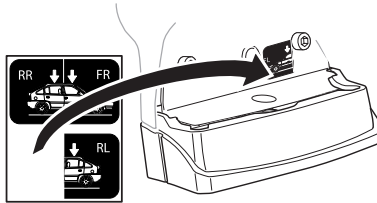
3**x1**

4

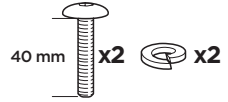
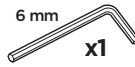
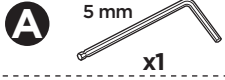

A

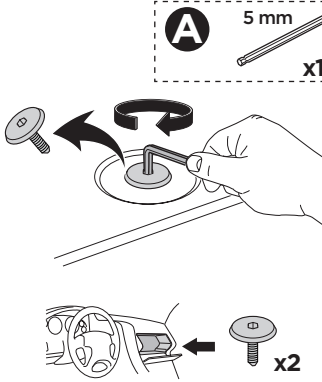

B

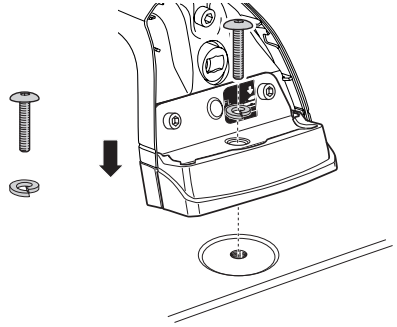

C

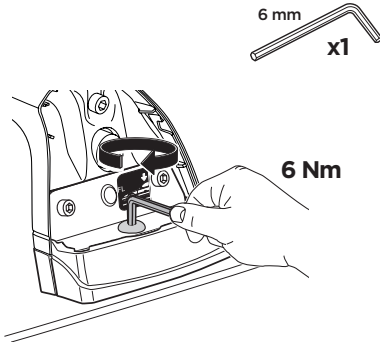

D

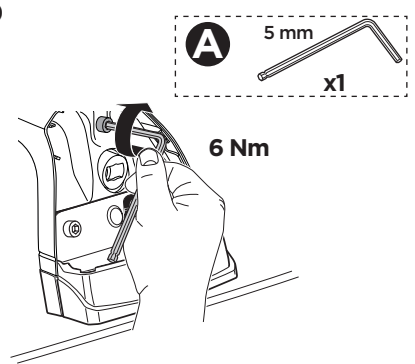

E

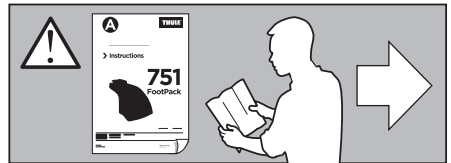
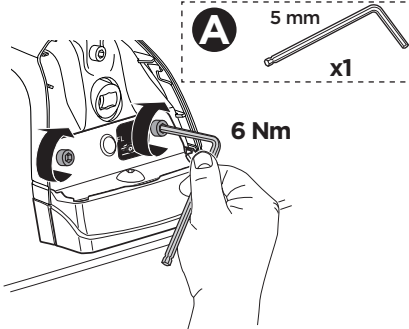

4

753
FootPack

A

5 mm



x1

6 mm

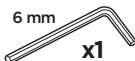

x1

40 mm



x4

x4



A

A

5 mm



x1

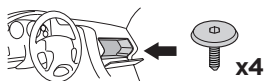
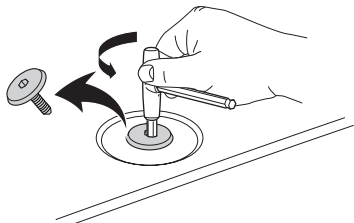

x4

B

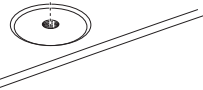
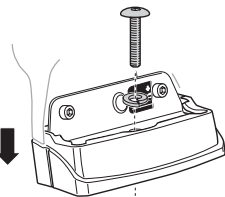

C

6 mm

x1

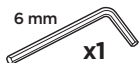

6 Nm

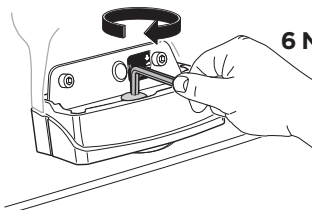

D

A

5 mm



x1

6 Nm

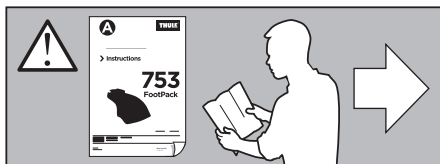
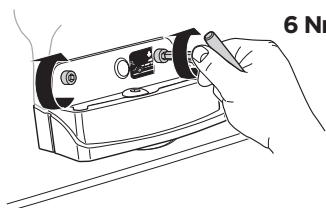



Thule Sweden AB, Borggatan 5, 335 73 Hillerstorp, SWEDEN
Thule Inc., 42 Silvermine Road, Seymour, Connecticut 06483, USA



info@thule.com
Phone: 800-238-2388



www.thule.com