

# Artikel-Nummer. 727504 MERCEDES BENZ

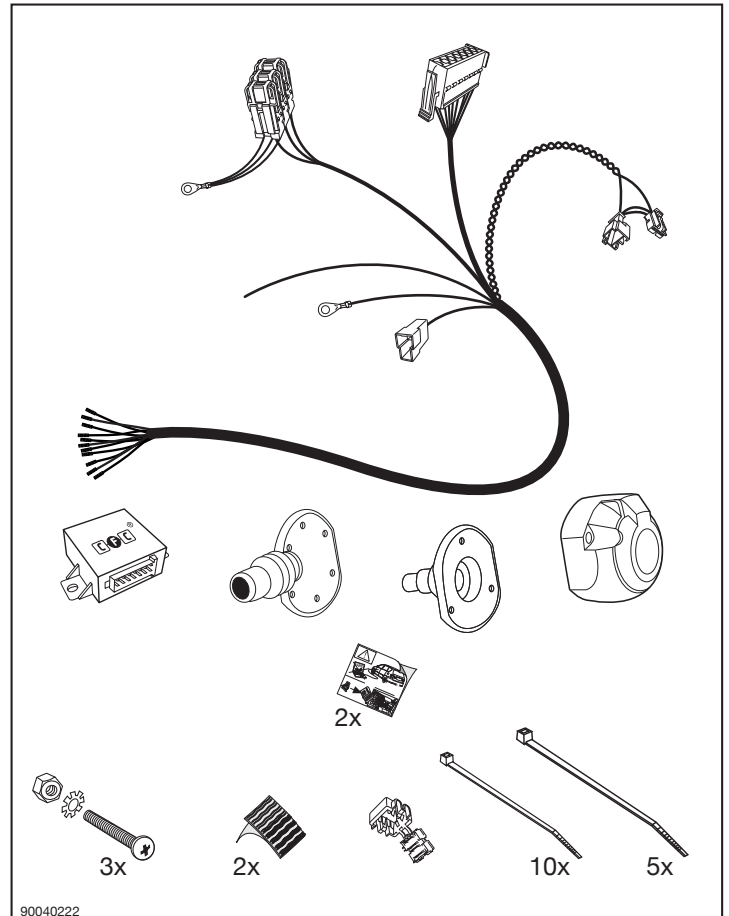

M-Klasse W164  
M-Class W164

07/05 →  
07/05 →

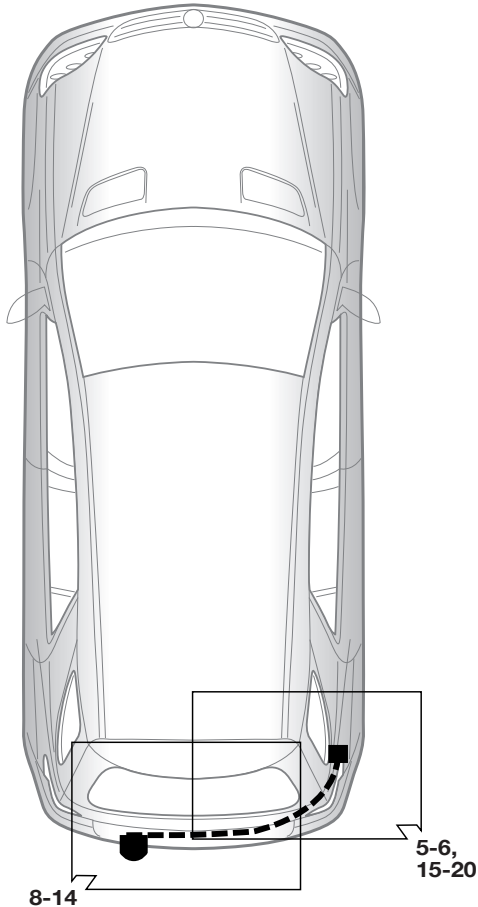

**!** Der Einbau dieses Elektrosatzes muß von einer Fachwerkstatt oder einer entsprechend qualifizierten Person durchgeführt werden. Vor Beginn aller Montagearbeiten unbedingt die Einbauanleitung komplett durchlesen. Nach Einbau des Elektrosatzes ist die Einbauanleitung den Serviceunterlagen des Fahrzeuges beizulegen!

**!** Installation of the towing electric kit must be undertaken by a specialist workshop or an appropriately qualified person. Before starting work, you must read the installation instructions through completely. After installing the towing electric kit, the installation instructions should be kept with the vehicle service documentation.

**!** Le montage du kit de connexion électrique doit être effectué par un atelier spécialisé ou par une personne qualifiée en la matière. Avant le début des travaux, lire impérativement les instructions de montage dans leur intégralité. Après le montage du kit de connexion électrique, joindre les instructions de montage aux documents du véhicule.

**!** L'installazione del kit elettrico deve essere effettuata da un'officina o da personale specializzato. Prima di iniziare tutti i lavori di montaggio, leggere da cima a fondo le istruzioni. Dopo aver installato il kit elettrico si prega di allegare le istruzioni di montaggio ai documenti di manutenzione del veicolo!

Bei unsachgemäßer Anwendung oder Veränderung des Elektrosatzes bzw. der darin befindlichen Bauteile erlischt jeder Anspruch auf Gewährleistung. Beim Fahren ohne Anhänger oder Ladungsträger müssen ggf. verwendete Adapter immer aus der Steckdose entfernt werden. Änderungen bezüglich Konstruktion, Ausstattung, Farbe sowie Irrtum vorbehalten. Alle Angaben und Abbildungen unverbindlich.

All claims under the guarantee will lapse in case of improper use or modification of the towing electric kit or any of its component parts. When driving without a trailer or load carrier, any adapter installed must be removed from the electrical socket. We reserve the right to alter the design, content or colour. We accept no liability for any errors in these instructions. All details and illustrations are non-binding.

Un usage inapproprié ou des modifications du kit de connexion électrique, ou des pièces qui le composent, entraînent l'expiration de tout droit à la garantie. Lors d'une conduite sans remorque ou porteur de charge, les adaptateurs utilisés doivent, le cas échéant, toujours être enlevés de la prise de courant. Sous réserve de modifications de constructions, équipement, couleurs ou erreur. Données et illustrations sous toute réserve.

In caso di uso improprio o di modifiche del kit elettrico e delle componenti del medesimo, ogni diritto di garanzia decade. Durante la guida senza rimorchio o portacarichi, togliere sempre gli adattatori dalla presa di corrente. Con riserva di modifiche relative a costruzione, equipaggiamento, colore e salvo errori. Tutte le indicazioni e illustrazioni non sono vincolanti.

Bei Anhängern ohne Nebelschlussleuchte sollte diese nachgerüstet werden.

In case of missing a rear fog lamp on the trailer, it should be retrofitted.

Pour les remorques qui ne sont pas équipées avec feux anti-brouillard arrière, il devrait être installé.

In caso di rimorchi non corredati di luce retronebbia, questa dovrebbe essere installata.

Für technische bzw. elektronische Änderungen, welche nach erstmaliger Inbetriebnahme des Elektrosatzes vom Fahrzeughersteller durchgeführt werden und beispielsweise zu Fehlfunktionen der Anhängersteckdose oder deren Peripherie führen, übernehmen wir keinerlei Gewährleistung!

We accept no responsibility and give no guarantee for technical and electrical modifications made after the initial operation of the towing electric kit by the vehicle manufacturer and which may lead, for example to malfunction of the trailer socket or its peripheries.

Nous n'assumons aucune responsabilité ni garantie pour les modifications techniques et électroniques ayant été effectuées après la première mise en service du kit de connexion électrique par le constructeur automobile et ayant mené par exemple à des mauvais fonctionnements de la prise de remorque ou de sa périphérie.

Per le modifiche tecniche ed elettroniche eseguite dopo la prima messa in funzione del kit elettrico da parte del costruttore del veicolo, e che portano, per esempio, a un malfunzionamento della presa del rimorchio o della sua periferia, non ci assumiamo alcuna responsabilità!

Das Anhängermodul ist nicht diagnosefähig! Sollten herstellereitige Diagnoseprozesse bzw. softwaregestützte Prüfmechanismen Fehlerprotokolle generieren, welche direkt oder indirekt mit Anhängerbetrieb in Zusammenhang stehen, ist das Anhängermodul vom Leitungssatz für die Anhängersteckdose zu trennen und ein nochmaliger Diagnosevorgang zu starten!

The trailer module is not diagnostics-capable. If the manufacturer's diagnostics processes or software-supported test mechanisms generate error reports directly or indirectly linked with trailer operation, the trailer module must be disconnected from the leads to the trailer socket and a new diagnostic process initiated.

Le module remorque ne contient pas de fonction diagnostic! Au cas où des processus de diagnostic définis par le fabricant ou des mécanismes de contrôle assistés par ordinateur devaient générer des messages d'erreur directement ou indirectement en rapport avec le fonctionnement de la remorque, il est impératif pour la prise de remorque de détacher le module remorque du groupe électrique et d'initier une nouvelle procédure de diagnostic.

Il modulo del rimorchio non è idoneo alla diagnosi! Nel caso in cui processi diagnostici o apparecchiature di prova controllate da software dovessero generare dei protocolli d'errore in rapporto diretto o indiretto con l'uso del rimorchio, si deve staccare il modulo del rimorchio dal conduttore per la presa del rimorchio, e avviare nuovamente la diagnosi!

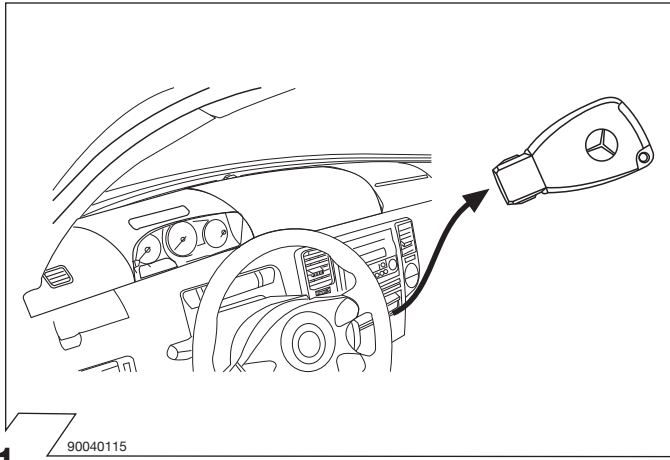

1

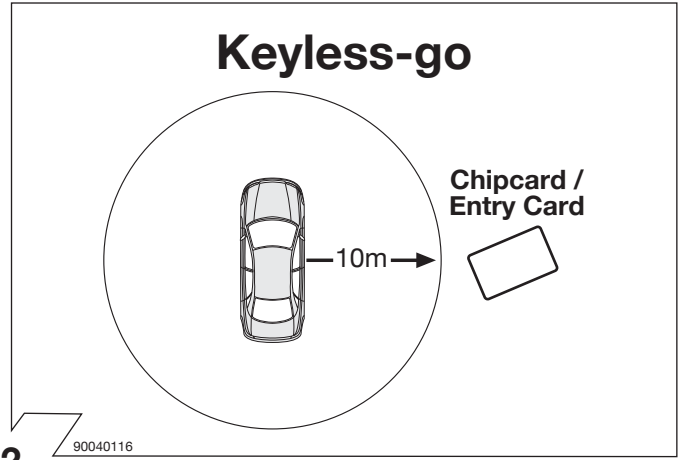

2

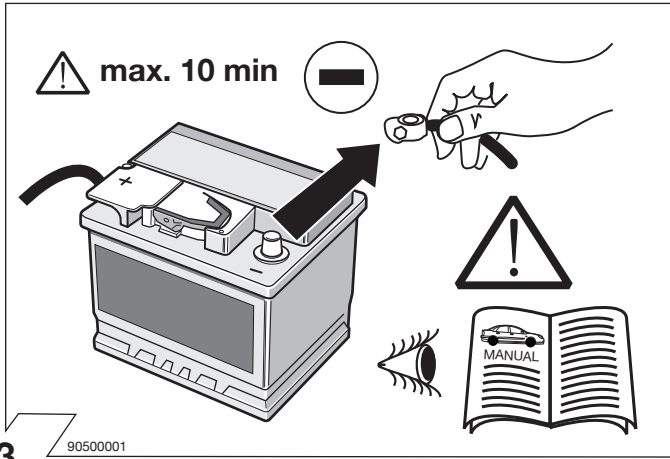

3

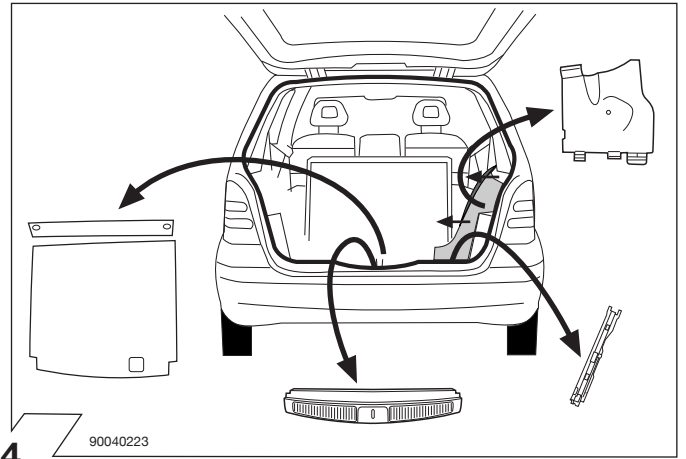

4

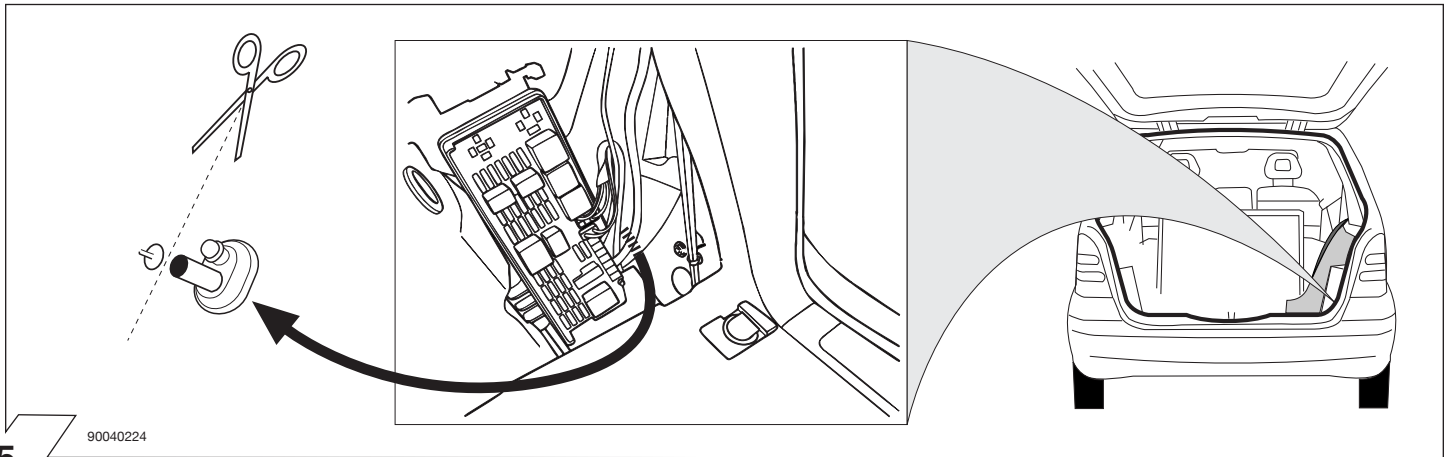

5

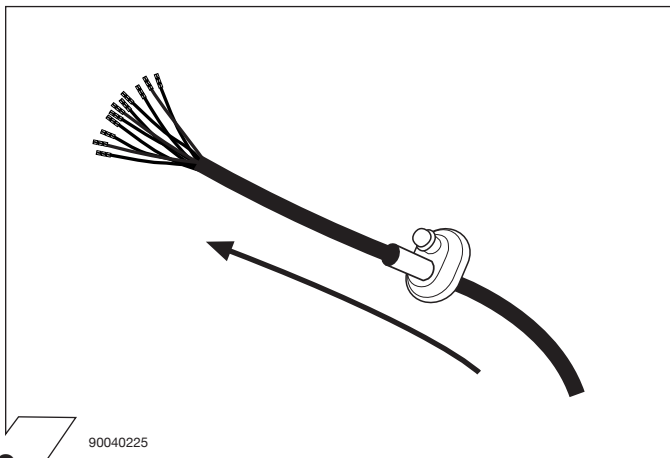

6

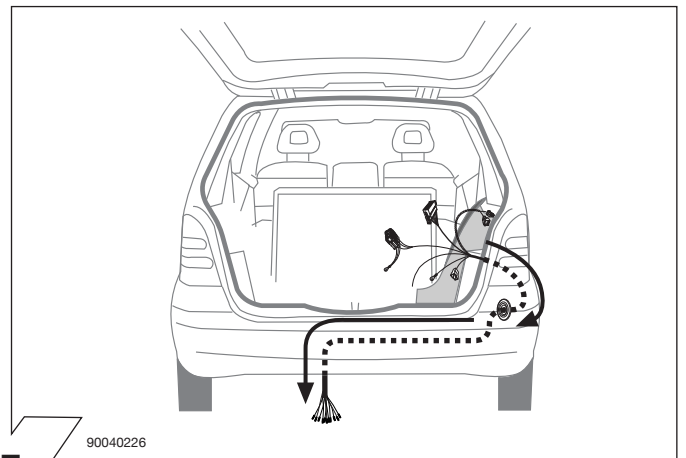

7

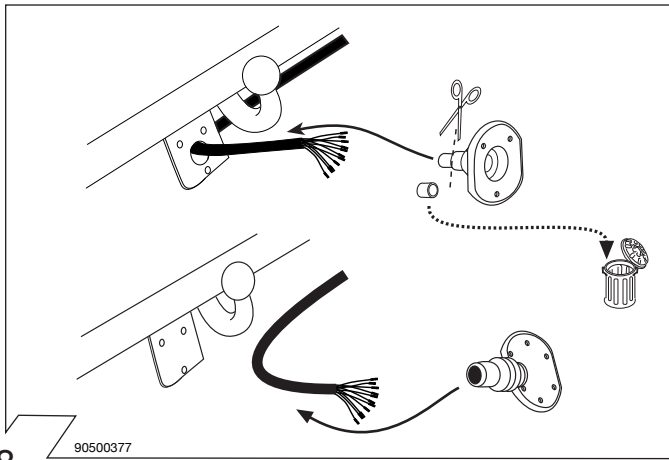

8

90500377

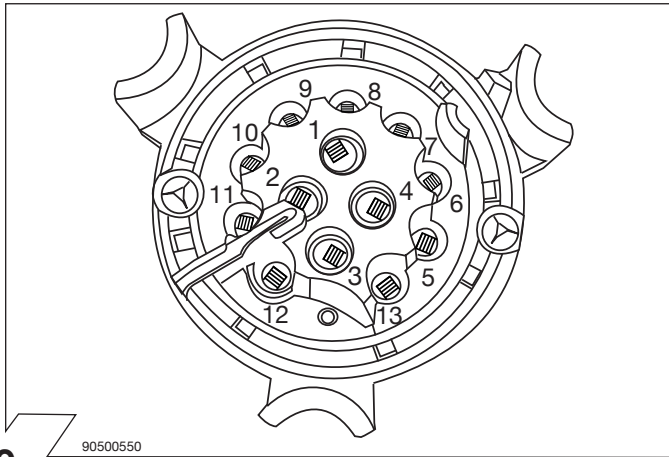

9

90500550

ISO 11446	Belegung der Steckdose / Maximale Ausgangsleistung Socket configuration / Maximum power output Correspondance des contacts de la prise / Puissance de sortie maximale Abbinamento della presa / Uscita di alimentazione massima		
	1/L	BK/WT	21W
	2	WT	42W
	3/31	BR	
	4/R	BK/GN	21W
	5/58-R	GY/RD	52W
	6/54	BK/RD	63W
	7/58-L	GY/BK	52W
	8	BL/RD	42W
	9	RD	240W
	10	YL	180W
	11	YL/BR	
	12		
	13	RD/BR	

10

90020157

	GB	D	E	F	I	P	NL	DK	N	S	FIN	CZ	H	PL
BK	Black	Schwarz	Negro	Noir	Nero	Preto	Zwart	Sort	Svart	Svart	Musta	Černá	Fekete	Czarny
RD	Red	Rot	Rojo	Rouge	Rosso	Vermelho	Rood	Rød	Röd	Röd	Punainen	Červená	Piros	Czerwony
GN	Green	Grün	Verde	Vert	Verde	Verde	Groen	Grøn	Grønt	Grön	Vihreä	Zelená	Zöld	Zielony
OR	Orange	Orange	Naranja	Orange	Arancione	Laranja	Oranje	Orange	Orange	Orange	Oranssi	Oran•ová	Narancs	Pomarańczowy
VT	Violet	Violett	Violeta	Violet	Viola	Violeta	Violet	Violet	Fiolett	Violett	Violetti	Fialová	Ibolya	Fioletowy
PK	Pink	Pink	Pink	Rose	Rosa	Cor-de-Rosa	Paars	Pink	Pink	Rosa	Pinkki	Růžová	Rózsaszín	Różowy
BL	Blue	Blau	Azul	Bleu	Blu	Azul	Blauw	Blå	Blått	Blå	Sininen	Modrá	Kék	Niebieski
YL	Yellow	Gelb	Amarillo	Jaune	Giallo	Amarelo	Geel	Gul	Gult	Gul	Keltainen	•lutá	Sárga	Żółty
WT	White	Weiss	Blanco	Blanc	Bianco	Branco	Wit	Hvid	Hvitt	Vit	Valkoinen	Bílá	Fehér	Biały
BR	Brown	Braun	Marrón	Brun	Marrone	Marrom	Bruin	Brun	Brunt	Brun	Ruskea	Hnědá	Barna	Brazowy
GY	Grey	Grau	Gris	Gris	Grigio	Cinzeno	Grijs	Grå	Grått	Grå	Harmaa	•edá	Szürke	Szary

11

90500580

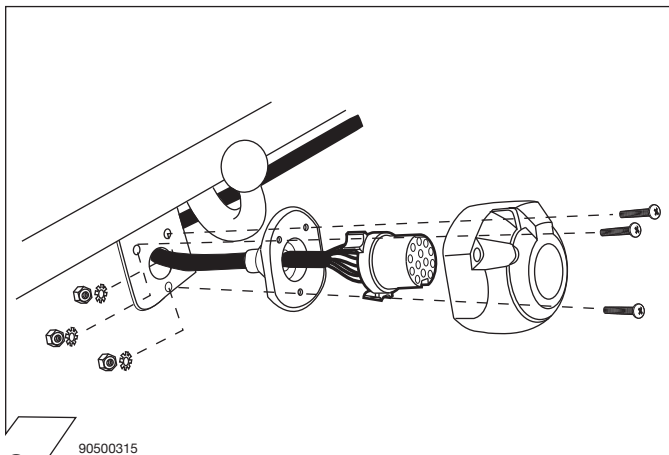

12

90500315

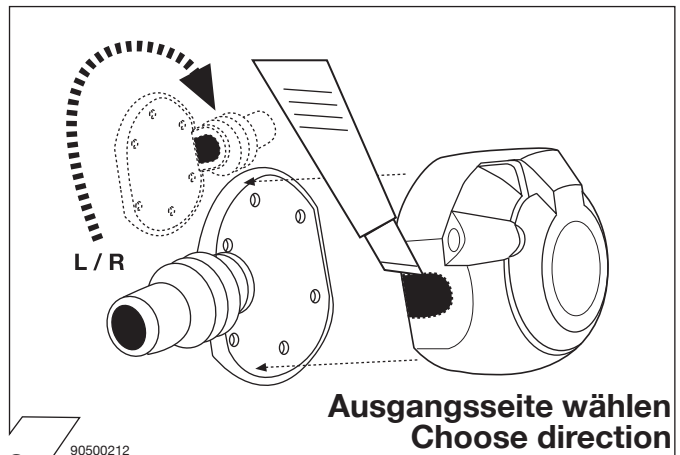

13

90500212

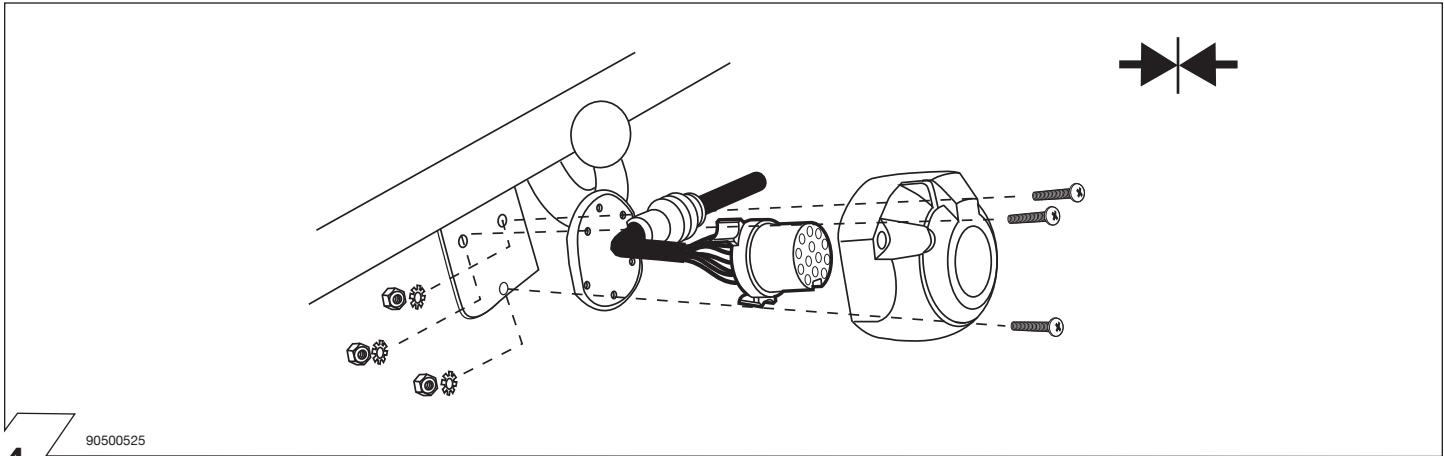

14

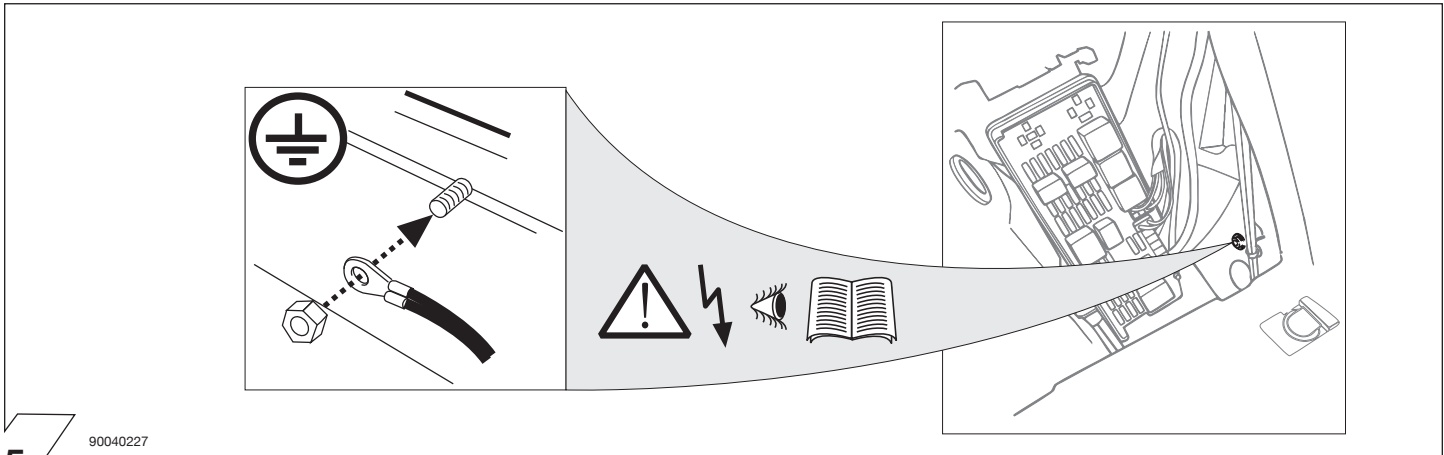

15

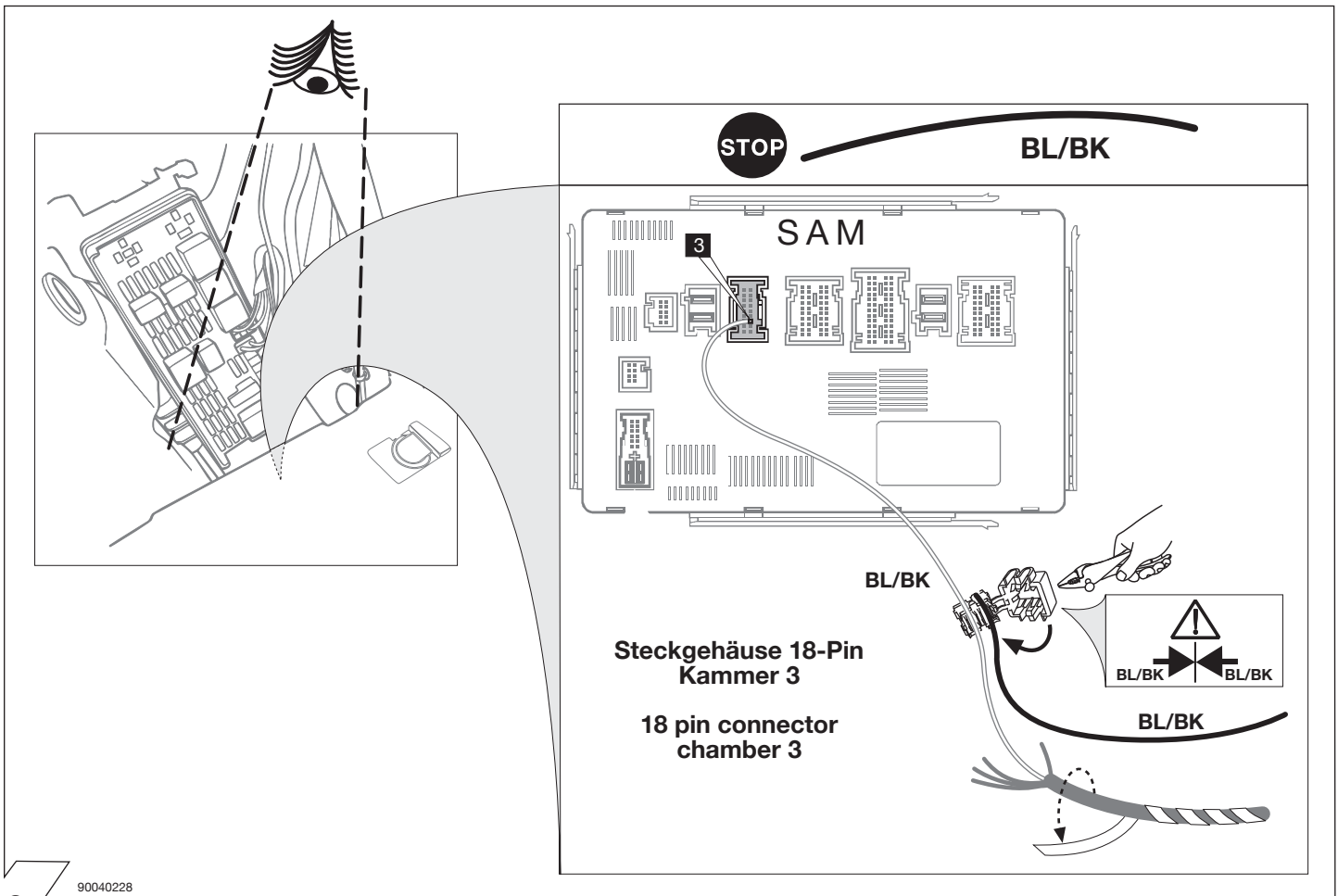

16

# CAN-Data Wire

BR  
BR/RD

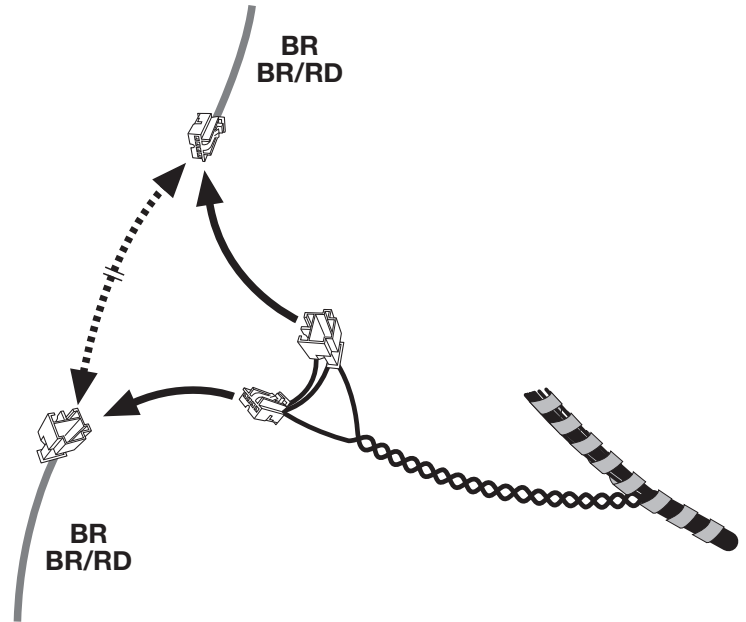
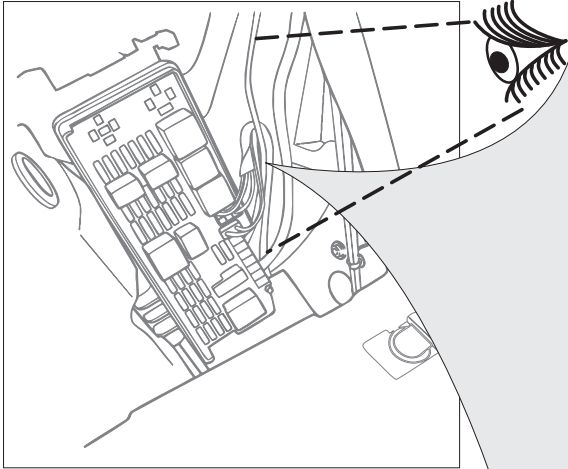

17

90040229

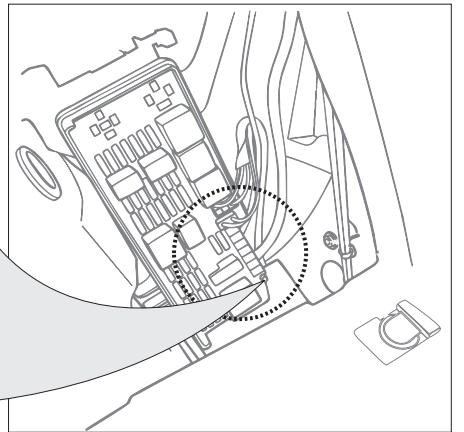
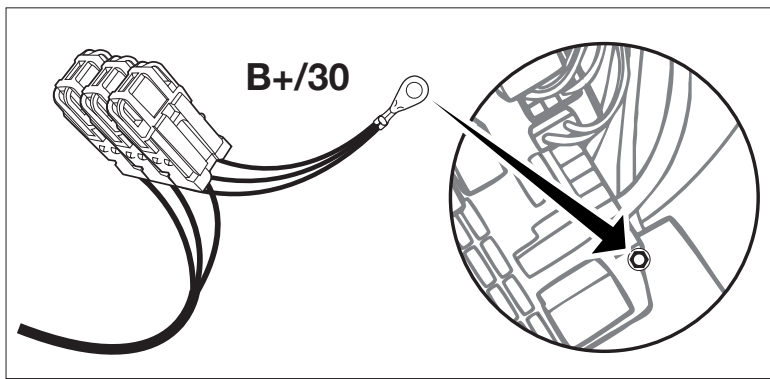

18

90040230

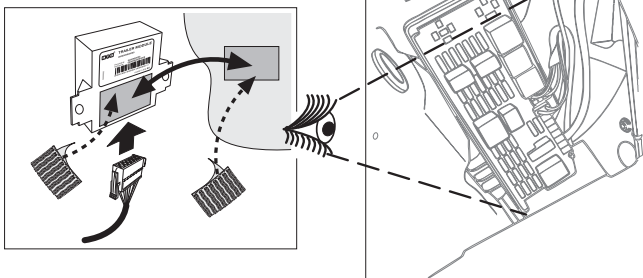

19

90040231

## OPTIONAL

YL/BR  
YL

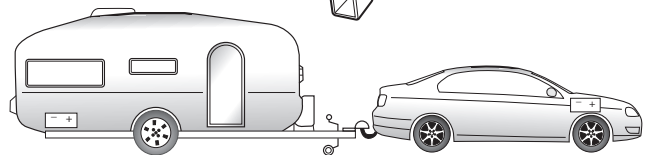

20

90500577

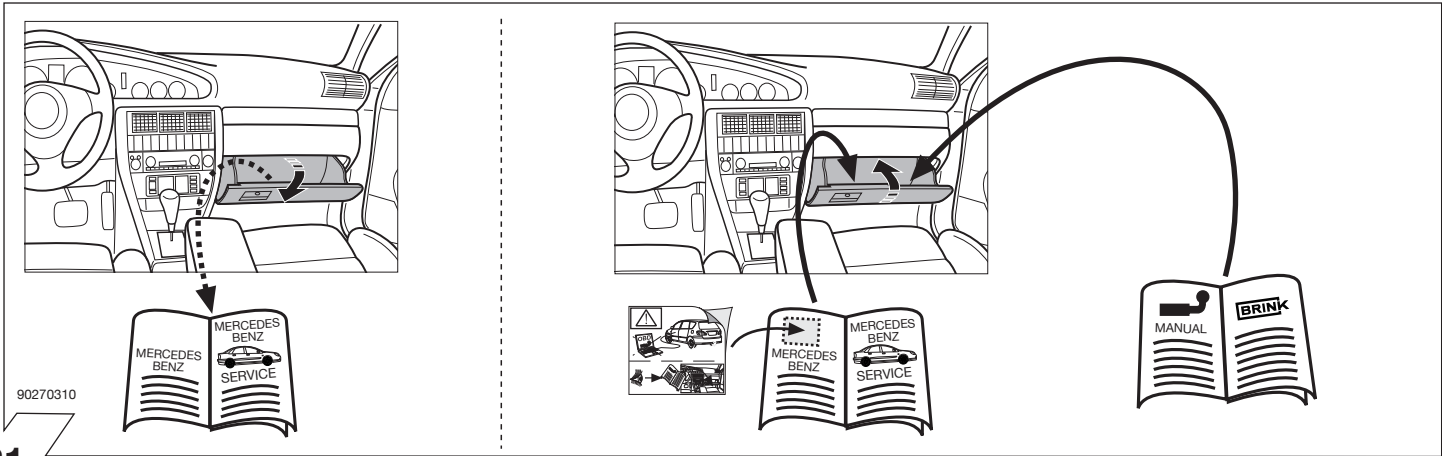

21

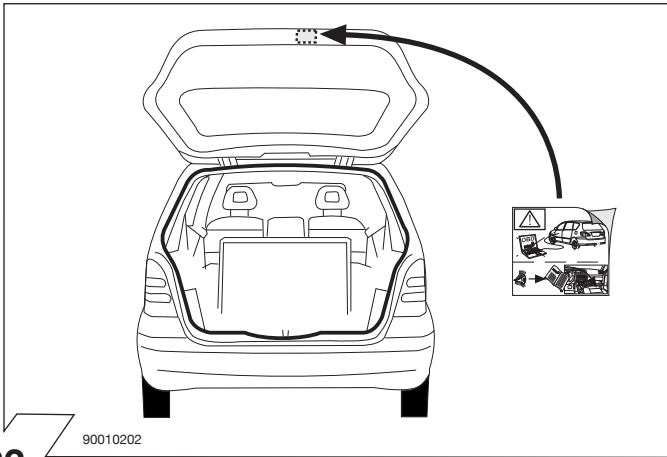

22

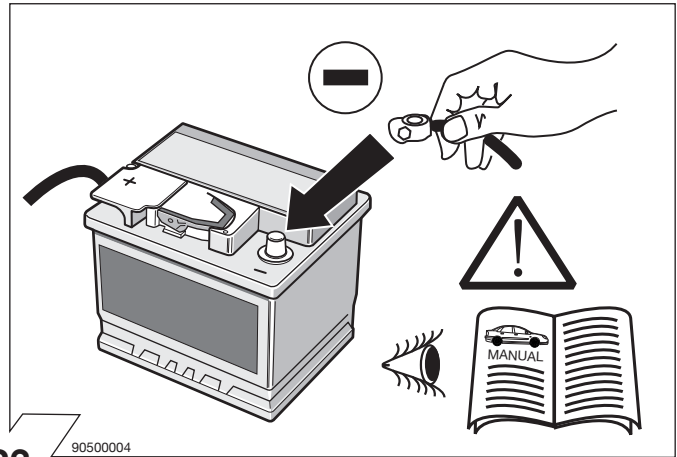

23

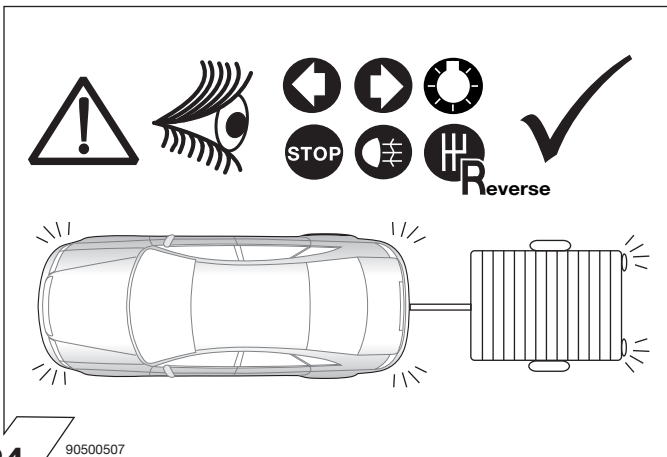

24

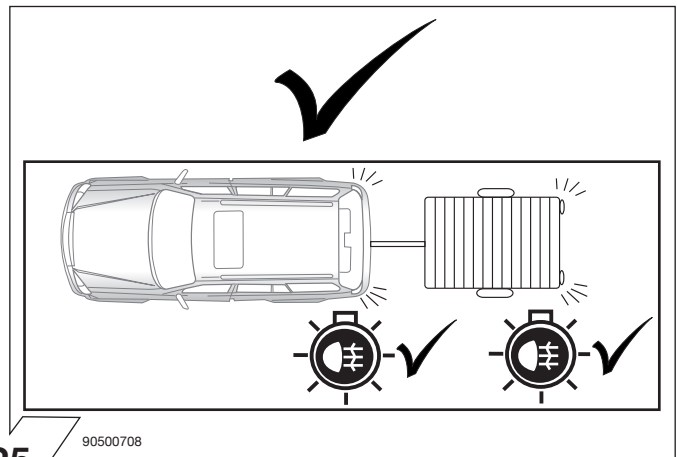

25

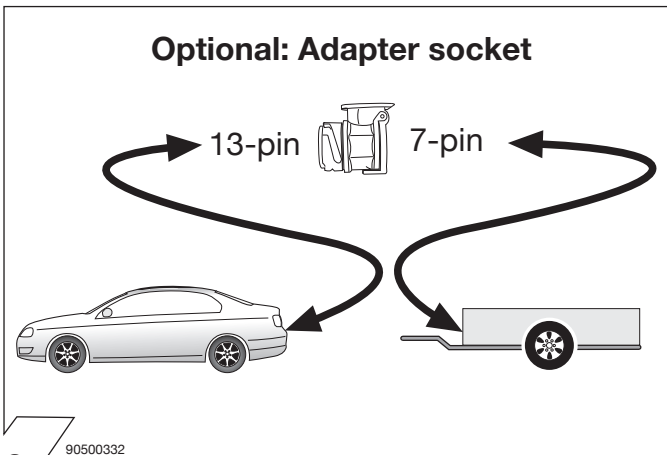

26

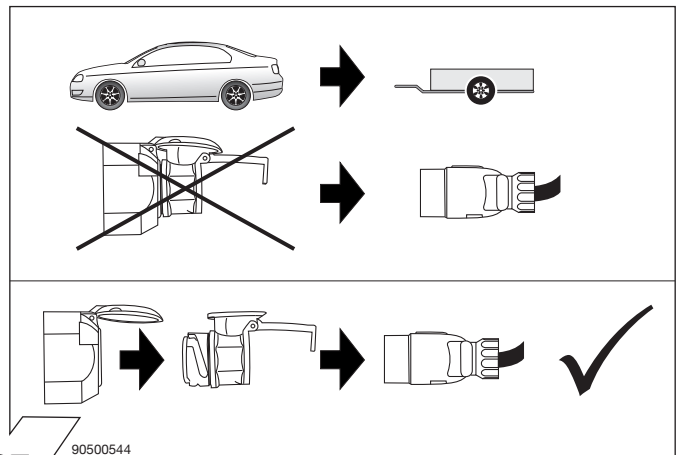

27



## Anhängerbetrieb konfigurieren / Set up trailer operation

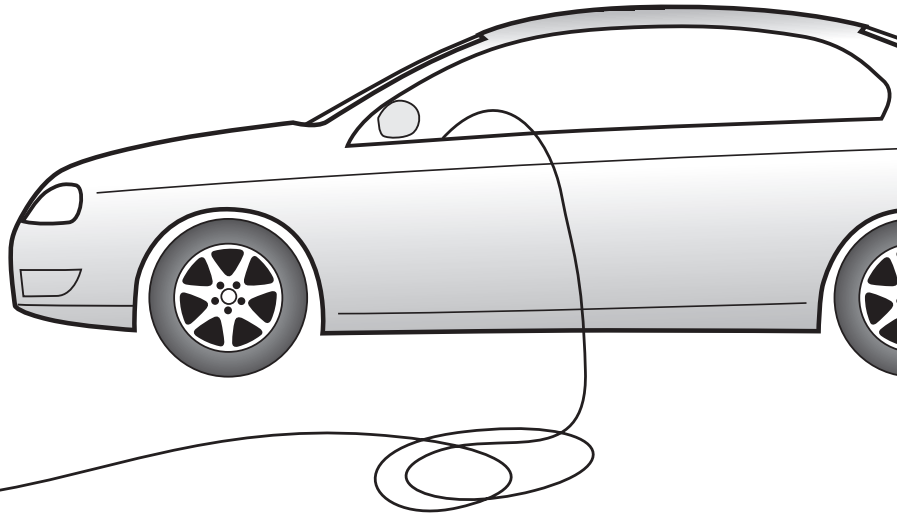
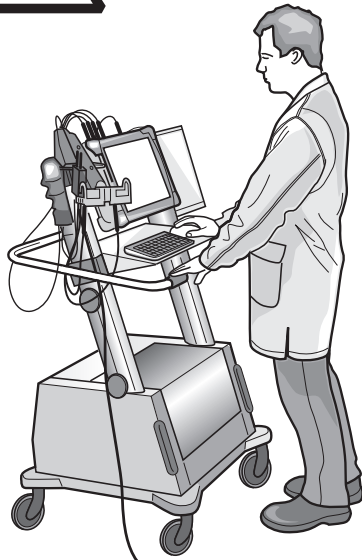

**D**

### Allgemein

Nach Einbau des E-Satzes sind die obligatorische Anhängerbeleuchtung sowie die in einigen Ländern gesetzlich vorgeschriebene Anhängerblinküberwachung ohne jede Freischaltung am Fahrzeug gewährleistet! Ein Defekt eines Fahrtrichtungsanzeigers am Anhänger wird dem Fahrer über das Informationsdisplay im Kombi-Instrument angezeigt!

### Fahrzeuge mit Einparkhilfe

Die automatische Deaktivierung der rückwärtigen Einparkhilfe im Anhängerbetrieb wird durch nachfolgende Codierung via Diagnose-Assistenz-System erreicht:

- Steuergeräte
- Aufbau
- ZGW - Zentrales Gateway
- Steuergeräte-Anpassungen
- Codierung lesen und gegebenenfalls ändern
- Anhängererkennung (auf vorhanden schalten!)
- Codierung durchführen (F5)

Nach erfolgter Codierung wird neben der Deaktivierung einer rückwärtigen Einparkhilfe im Anhängerbetrieb auch der Ausfall eines Fahrtrichtungsanzeigers am Anhänger als erweiterte Fehlermeldung im Informationsdisplay des Kombi-Instruments dargestellt, verbunden mit einer Blinkfrequenzerhöhung der fahrzeugseitigen Kontrollleuchte für Fahrtrichtungsanzeige!



**GB**

### General

After building-in the electrical kit, the mandatory trailer lighting and the trailer indicator monitoring that is prescribed by law in some countries are available with no further switching in the vehicle! Any defect in the trailer direction indicators is shown to the driver by the information display of the instrument panel!

### Vehicles with parking assistance

Automatic deactivation of the reversing parking assistance when towing a trailer, is effected by the following coding through the diagnostic assistance system:

- control devices
- construction
- ZGW – central gateway
- control device adjustment
- read the coding and change if necessary
- trailer recognition (switch to "present")
- execute coding (F5)

After coding, in addition to the deactivation of the reversing parking assistance when towing a trailer, the failure of a trailer direction indicator is also shown as an extended defect report in the information display of the combination instrument, coupled with an increase in the frequency at which the control light for the direction indicators in the vehicle blinks!



**F**

### Généralités

Après le montage d'un kit électrique, l'éclairage obligatoire de la remorque ainsi que la surveillance – prescrite dans certains pays – des indicateurs de direction de la remorque sont assurés sur le véhicule, sans qu'aucune validation ne soit nécessaire! Un défaut de l'indicateur de direction de la remorque est signalé au conducteur sur le panel de contrôle!

### Véhicules avec aide au parking

La désactivation automatique de l'aide au parking montée à l'arrière, lors de l'utilisation d'une remorque est obtenue par le codage suivant sur le système d'assistance et de diagnostic:

- systèmes de commande
- structure
- ZGW - Gateway central
- paramétrage des systèmes de commande
- lire et modifier éventuellement le codage
- détection de la remorque (basculer sur présente!)
- exécuter le codage (F5).

Lorsque le codage est effectué, outre la désactivation de l'aide au parking montée à l'arrière, en présence d'une remorque, la panne d'un indicateur de direction de la remorque est présentée comme un message d'erreur étendu sur l'affichage d'information de l'instrument combiné, associée à une augmentation de la fréquence de clignotement des voyants de contrôle des indicateurs de direction, côté conducteur!



**I**

### Informazioni generali

Dopo l'installazione del kit elettrico l'illuminazione obbligatoria del rimorchio ed il controllo dei lampeggianti del rimorchio (obbligatorio in alcuni paesi) sono garantiti senza alcuna attivazione! Il guasto di un indicatore di direzione del rimorchio è segnalato al guidatore attraverso il display informativo nel pannello di controllo!





























### Veicoli con sensori di parcheggio

La disattivazione automatica dei sensori di parcheggio posteriori in presenza di un rimorchio è ottenuta tramite la seguente codificazione con il sistema di assistenza alla diagnosi:

- Sistemi di controllo
- Organizzazione
- ZGW – Gateway centrale
- Modifiche ai sistemi di controllo
- Leggere la codifica e modificare se è il caso
- Riconoscimento del rimorchio (commutare su presente!)
- Eseguire la codifica (F5)

Dopo avere completata la codifica, oltre alla disattivazione dei sensori di parcheggio posteriori quando è presente un rimorchio, il display informativo dello strumento multifunzione indica anche eventuali guasti agli indicatori di direzione del rimorchio, insieme ad un aumento della frequenza di lampeggio delle spie degli indicatori di direzione del veicolo!

90500700

ERKLÄRUNG SYMBOLE	SYMBOL EXPLANATION	EXPLICATION DES SIMBOLES	SPIEGIAZIONE DEI SIMBOLI	EXPLICACIÓN DE LOS SIMBOLES
(D)	(GB)	(F)	(I)	(E)
	left (58-L) respectively right (58-R) tail light	feu arrière gauche (58-L) respectivement droite (58-R)	luce posteriore sinistra (58-L) rispettivamente destra (58-R)	pilato trasero izquierdo (58-L) respectivamente derecho (58-R)
	stop light (54) / high mounted, third stop light (54)	feu de stop (54) / 3ème feu de stop (54)	luce d'arresto (54) / 3. luce d'arresto (54)	tercera luz de freno (54) / luz indicadora de dirección de marcha izquierda
	turn signal indicator left	feu indicateur de direction gauche	indicatore di direzione sinistra	luz indicadora de dirección de marcha izquierda
	turn signal indicator right	feu indicateur de direction droite	indicatore di direzione destra	luz indicadora de dirección de marcha derecha
	rear fog light(s)	feu (x) arrière (s) de brouillard	fendinebbia	luz (-ces) trasera (s) antineblia (s)
	reversing light(s)	feu (x) de marche arrière	luce (i) retromarcia	luz (-ces) de marcha atrás
	Permanent power supply / 13pin socket, chamber 9	courant continué / prise de courant a 13 pôles, compartiment 9	alimentazione continua / presa 13 poli, camera 9	positivo continuo / caja de anclufe a 13 polos, cámara 9
	charging wire for trailer fridge / 13pin socket, chamber 10	cable de charge / prise de courant à 13 pôles, compartiment 10	cavo di carica / presa 13 poli, camera 10	cable de carga / caja de anclufe a 13 polos, cámara 10
	trailer / trailer recognition	détection de la fonction "remorque"	rimorchio / riconoscimento rimorchio	remolque / detección del remolque
	Permanent current power supply	courant continué / alimentation électrique permanente	corrente / alimentazione continua	positivo continuo / alimentación de corriente permanente
	Ground or Earth (31)	masse (31)	massa (31)	masa (31)
	ground connection battery terminal lug	borne "moins" de la batterie	connessione negativa della batteria	conexión negativa de batería
	positive connection battery terminal lug	borne "plus" de la batterie	connessione positiva della batteria	conexión positiva de batería
	fuse / fuse capacity 20 Ampère	fusible / ampérage 20 ampères	fusibile / fusibile con capacità 20 Ampère	fusible / amperaje 20 amperes
	cigarette lighter / accessory socket	allume-cigare / prise d'accessoires	accendisigari / presa accessori	encendido de cigarrillos / caja de accesorios
	loudspeaker / buzzer	haut-parleur / vibreur	altoparlante / cicalino	altavoz / señal acustica de advertencia
	park distance control	assistance au parking	senso di parcheggio	ayuda para aparcar
	switch / source of function	interrupteur / origine de fonction	interruttore / origine funzione	interruptor / origen de función
	Connect together	raccorder	connessione	conectar
	disconnect	séparer	sconnessione	separar
	Look at / see further information	considérer / voir informations ultérieures	considerare / vedere ulteriori informazioni	considerar / véase las informaciones
	look carefully at selected area	faire attention à la zone sélectionnée	considerare area selezionata	considerar el área seleccionada
	Present / Occupied / OK	disponible / occupé / OK	presente / occupato / OK	presente / ocupado / OK
	Not present / Not occupied / not OK	pas disponible / pas occupé / pas OK	non presente / non occupato / non OK	non presente / non ocupado / non OK
	left	gauche	sinistra	izquierdo
	right	droite	destra	derecho
	acoustic indication	signalisation acoustique	segnalazione acustica	señalación acústica
	attention / important advice	attention / indication importante	attenzione / indicazione importante	atención / indicación importante