

Kit 1236

MITSUBISHI Challenger, 5-dr SUV, 96-05

MITSUBISHI L200 (Mk 1), 4-dr Double Cab, 95-05

MITSUBISHI Montero Sport, 5-dr SUV, *96-06

MITSUBISHI Pajero Sport, 5-dr SUV, 96-05

*North America

480R
754

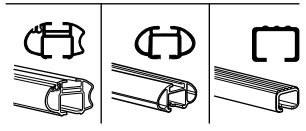
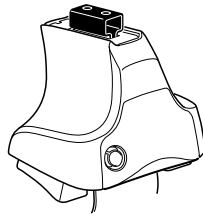

480

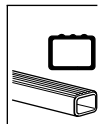
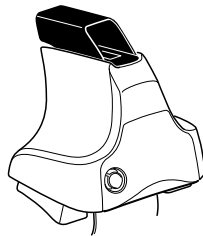

750

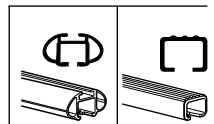
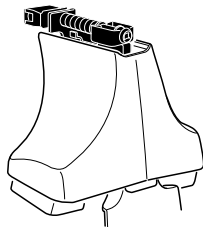

THULE[®]
SWEDEN

ISO 11154-E

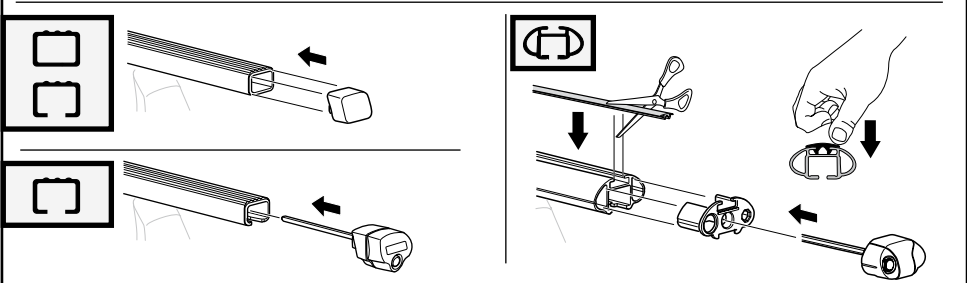
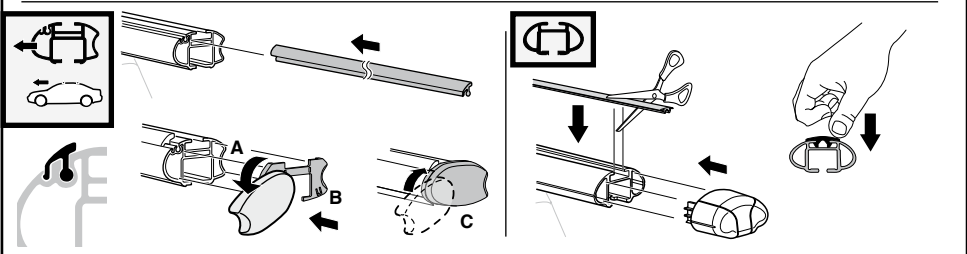
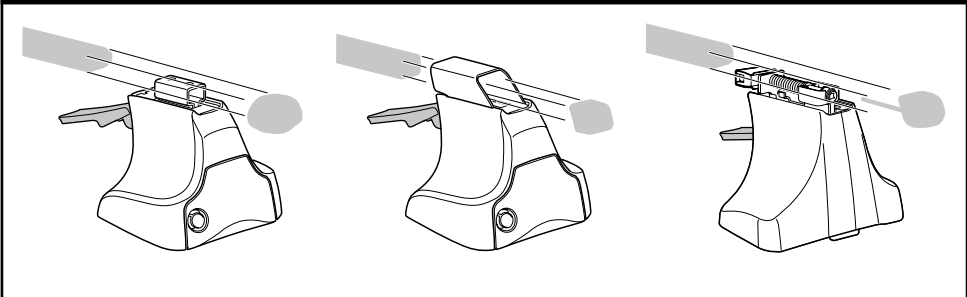
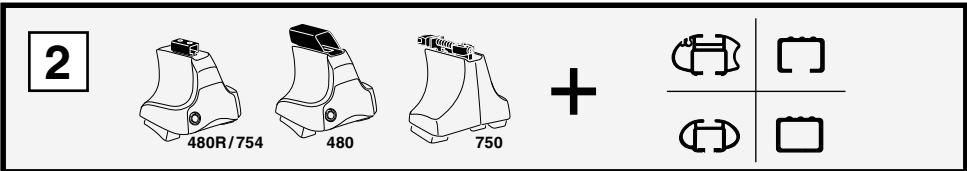
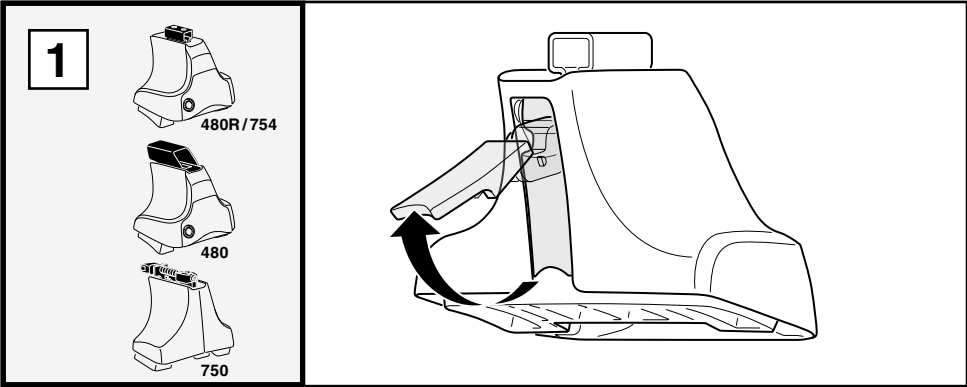

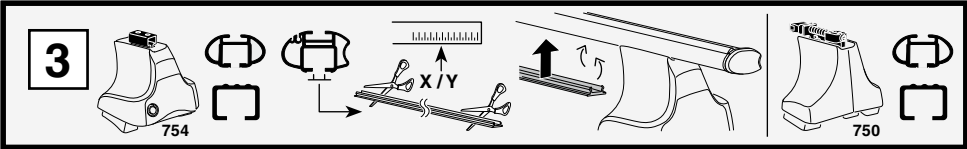

1

2

1

2

	X
MITSUBISHI Challenger, 5-dr SUV, 96-05	35,5
MITSUBISHI L200 (Mk 1), 4-dr Double Cab, 95-05	35,5
MITSUBISHI Montero Sport, 5-dr SUV, *96-06	35,5
MITSUBISHI Pajero Sport, 5-dr SUV, 96-05	35,5

	Y
MITSUBISHI Challenger, 5-dr SUV, 96-05	35,5
MITSUBISHI L200 (Mk 1), 4-dr Double Cab, 95-05	37
MITSUBISHI Montero Sport, 5-dr SUV, *96-06	35,5
MITSUBISHI Pajero Sport, 5-dr SUV, 96-05	35,5

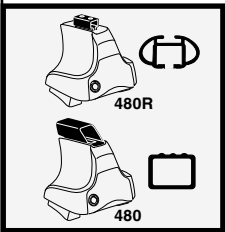

1

2

1

2

	X inch	X mm
MITSUBISHI Challenger, 5-dr SUV, 96-05	39 5/8"	1006 mm
MITSUBISHI L200 (Mk 1), 4-dr Double Cab, 95-05	39 5/8"	1006 mm
MITSUBISHI Montero Sport, 5-dr SUV, *96-06	39 5/8"	1006 mm
MITSUBISHI Pajero Sport, 5-dr SUV, 96-05	39 5/8"	1006 mm

	Y inch	Y mm
MITSUBISHI Challenger, 5-dr SUV, 96-05	39 5/8"	1006 mm
MITSUBISHI L200 (Mk 1), 4-dr Double Cab, 95-05	40 1/4"	1021 mm
MITSUBISHI Montero Sport, 5-dr SUV, *96-06	39 5/8"	1006 mm
MITSUBISHI Pajero Sport, 5-dr SUV, 96-05	39 5/8"	1006 mm

4

MITSUBISHI Challenger, 5-dr SUV, 96-05
MITSUBISHI L200 (Mk 1), 4-dr Double Cab, 95-05
MITSUBISHI Montero Sport, 5-dr SUV, *96-06
MITSUBISHI Pajero Sport, 5-dr SUV, 96-05

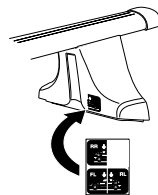
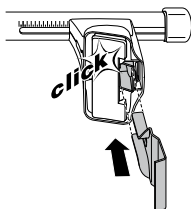
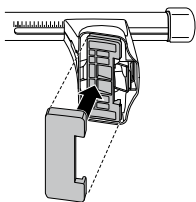
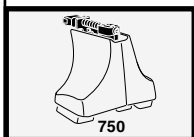
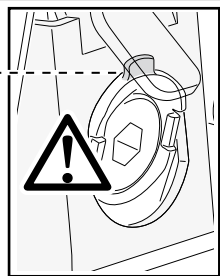
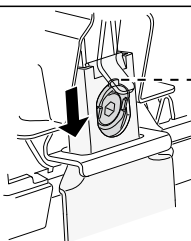
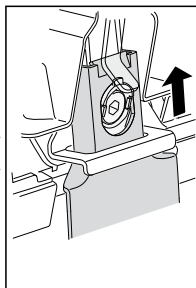
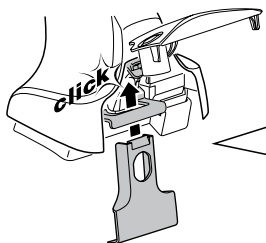
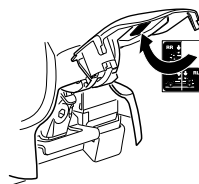
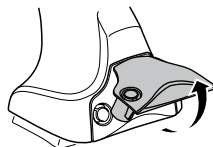
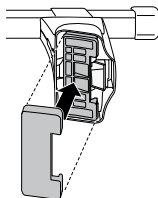
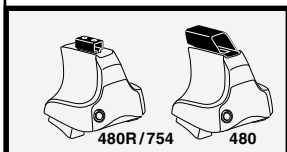
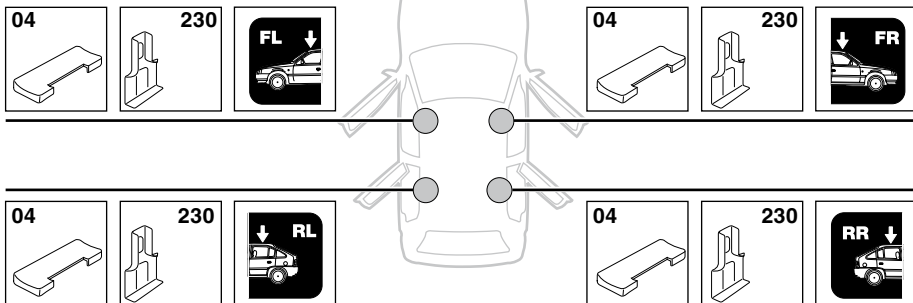

5

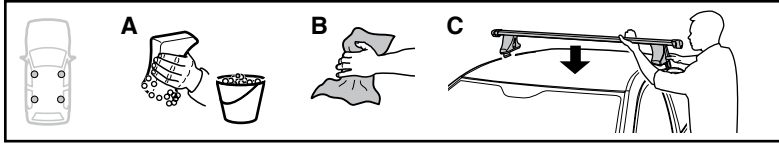

	X mm	Y mm	X inch	Y inch
MITSUBISHI Challenger , 5-dr SUV, 96-05	440 mm	700 mm	17 ³ / ₈ "	27 ¹ / ₂ "
MITSUBISHI L200 (Mk 1) , 4-dr Double Cab, 95-05	280 mm	750 mm	11 "	29 ¹ / ₂ "
MITSUBISHI Montero Sport , 5-dr SUV, *96-06	440 mm	700 mm	17 ³ / ₈ "	27 ¹ / ₂ "
MITSUBISHI Pajero Sport , 5-dr SUV, 96-05	440 mm	700 mm	17 ³ / ₈ "	27 ¹ / ₂ "

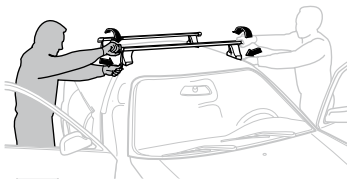
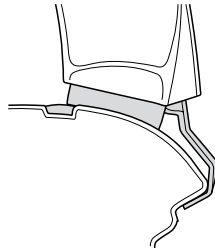
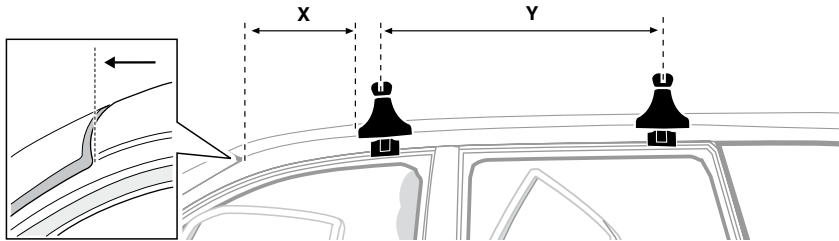

GB/US Tighten alternately

D Die Schrauben abwechselnd anziehen

F Serrer alternativement chaque côté

NL Afwisselend aan de linker- en de rechterkant aandraaien

I Alternare il serraggio delle viti

E Apretar alternativamente

PT Aperte alternadamente

S Dra åt växelvis

FIN Kierrä vuorotellen

EST Pinguldage vaheldumisi

LAT Pielvelciēt pamīšus

LIT Užsukinėkite pakaitomis

PL Śruby dokręcaj naprzemiennie

RU Затягивайте попеременно

CZ Pokręťta багаžnika dokręcaj dokręcaj naprzemiennie.

SK Doťahujte striedavo

SLO Privijajte izmenično.

HR Naizmjenično zategnite

HU Egymástól fűggetlenül szorítandó

GR Σφίγγετε εναλλάξ

TR Dönüşümlü sıkın

中文 交替拧紧

한국어 번갈아 가며 조이십시오.

日本語 交互に締め付けてください。

ไทย ชันในแบบสลับ

6



480R/754



480

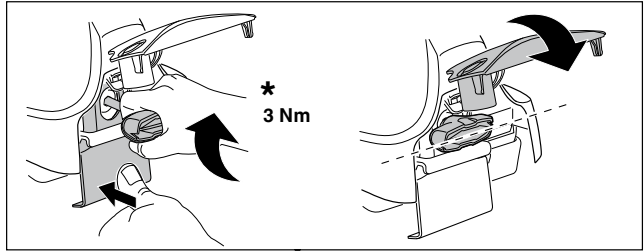
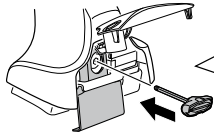

*
3 Nm

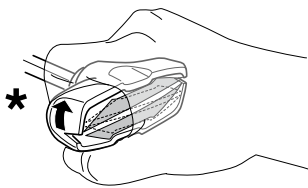

*

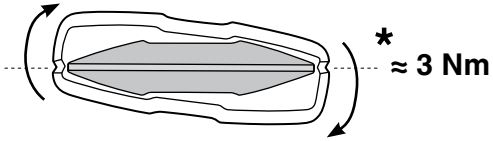

*
≈ 3 Nm

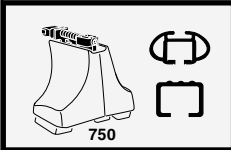
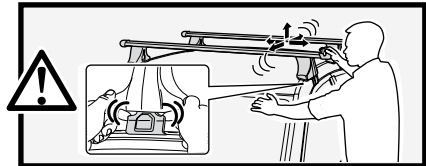

750

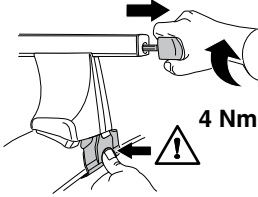

4 Nm

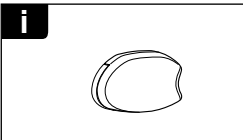
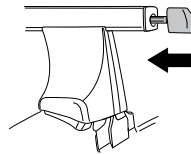

i

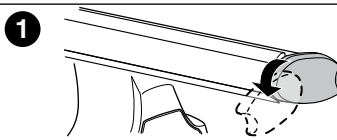

1

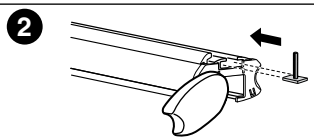

2

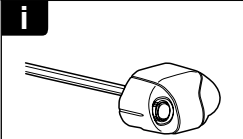

i

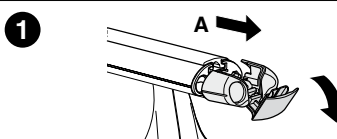

1

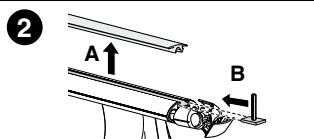

2

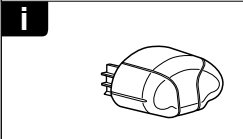

i

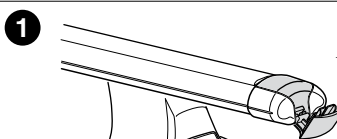

1

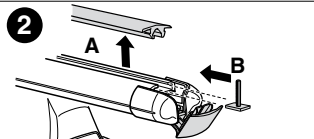

2

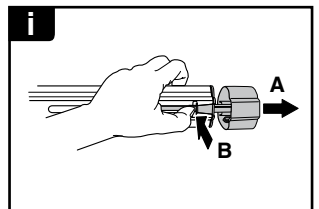
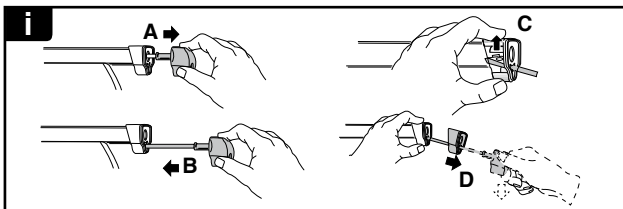
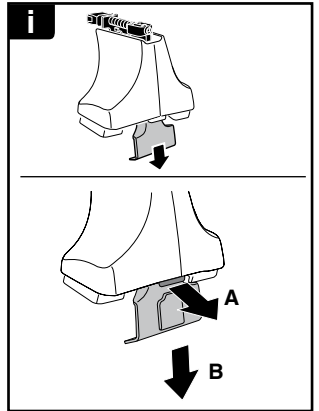
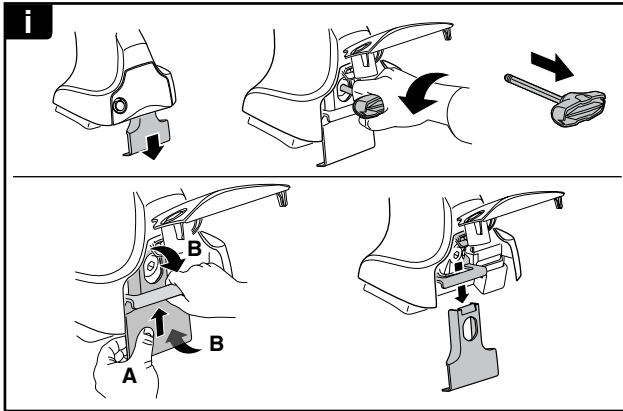
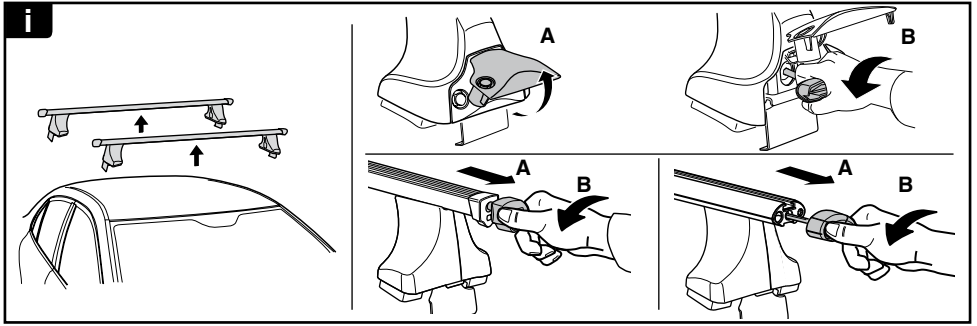

THULE
SWEDEN
**ONE
KEY
SYSTEM**

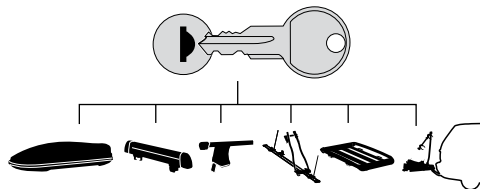

		544	(x4)
		596	(x6)
		588	(x8)
NA		510	(x10)
EUR		452	(x12)
ASIA			

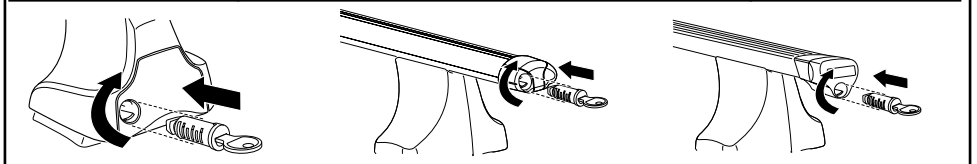

WW ▶ Thule Sweden AB, Box 69, 330 33 Hillerstorp, SWEDEN
NA ▶ Thule Inc., 42 Silvermine Road, Seymour, Connecticut 06483, USA

info@thule.com
customer.service@thule.com

www.thule.com



www.thuleprofessional.com



customer.service@thule.com



Thule Inc., 42 Silvermine Road, Seymour, Connecticut 06483, USA
Thule Sweden AB, Box 69, 330 33 Hillerstorp, SWEDEN

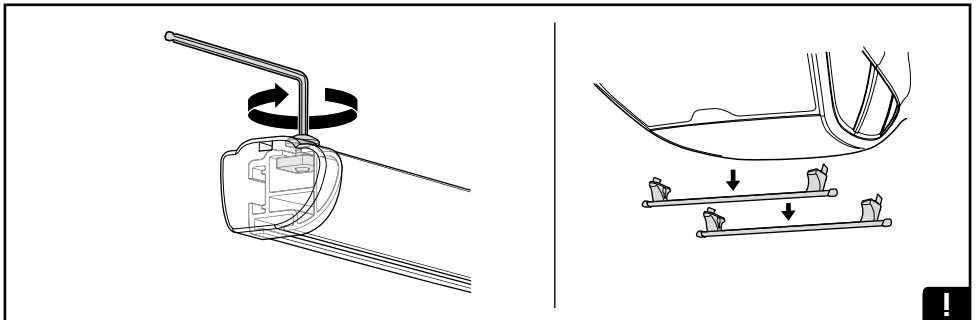
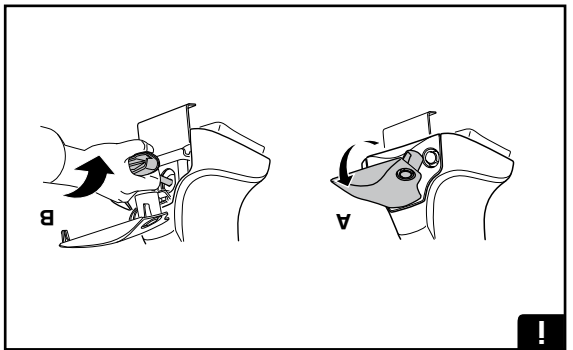
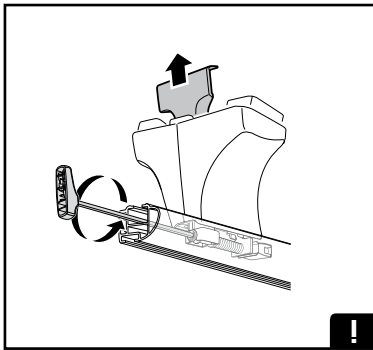
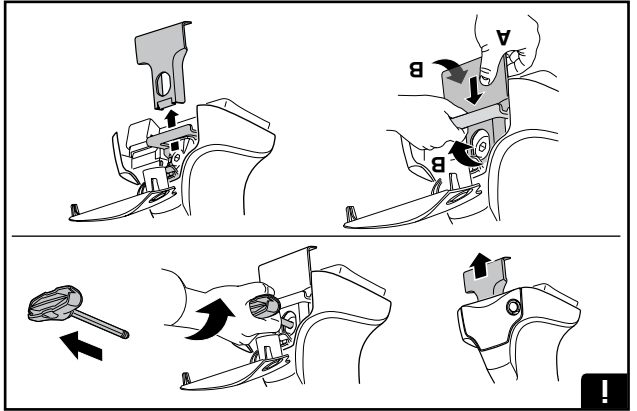
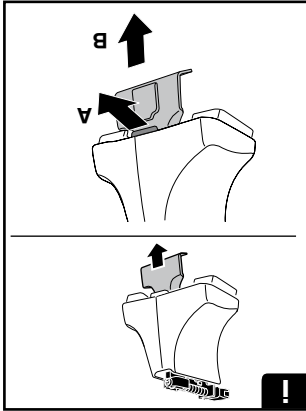

- S Dra åt växelvis
- PT Aperte alternadamente
- E Apretar alternativamente
- I Alternare il serraggio delle viti
- NL de rechterkant aan de linker- en Afwisselend aan de linker- en
- F Serrer alternativement chaque côté
- D Die Schrauben abwechselnd
- GB/US Tighten alternately

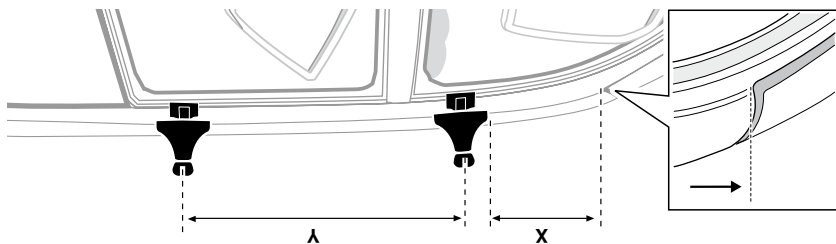
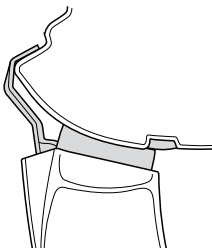
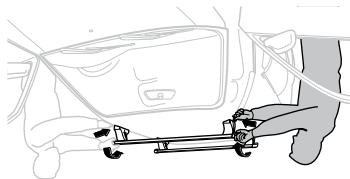

MITSUBISHI Challenger, 5-dr SUV, 96-05	440 mm	700 mm	17 ³ / ₈ "	27 ¹ / ₂ "
MITSUBISHI L200 (Mk 1), 4-dr Double Cab, 95-05	280 mm	750 mm	11 "	29 ¹ / ₂ "
MITSUBISHI Montero Sport, 5-dr SUV, *96-06	440 mm	700 mm	17 ³ / ₈ "	27 ¹ / ₂ "
MITSUBISHI Pajero Sport, 5-dr SUV, 96-05	440 mm	700 mm	17 ³ / ₈ "	27 ¹ / ₂ "

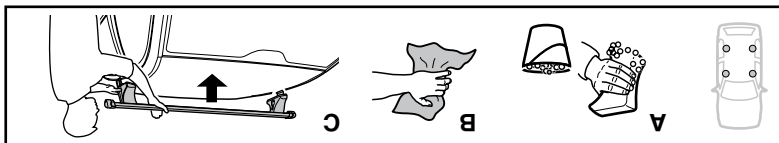

6

- FIN Kierrä vuorotellen
- EST Pinguldage vaheldumisi
- LAT Pīvelciēt pamīšus
- LIT Užsukinėkite pakaitomis
- PL Słubj dokręcaj naprzemiennie
- RU Затриваайте попеременно
- CZ Pokrétka bagazníka dokręcaj dokręcaj naprzemiennie.
- SK Dotiahnujte striedavo
- SLO Privijaite izmenično
- HR Naizmjerno zategnite
- HU Egyváltó félgyögetlenül szorítandó
- GR Σφύγγετε εναλλάξ
- TR Dönümlü sıkın
- 中文 交替拧紧
- 한국어 번갈아 가며 조이십시오.
- 日本語 交互に締め付けてください。
- ไทย สลับหมุนสลับ

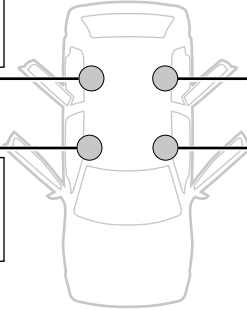
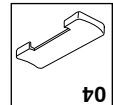
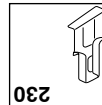
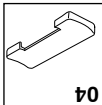
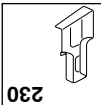
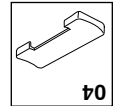
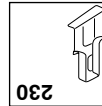
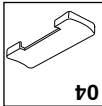
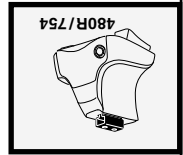
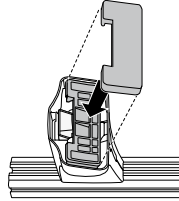
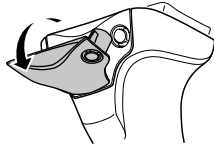
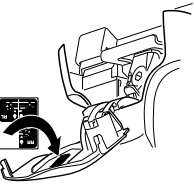
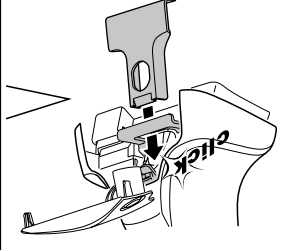
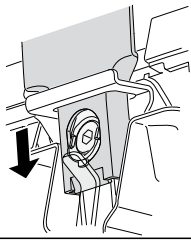
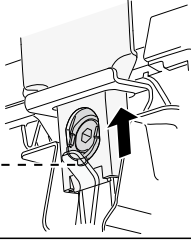
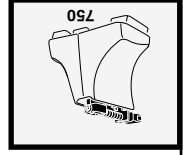
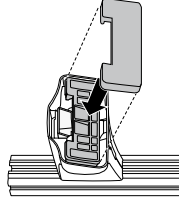
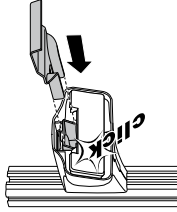
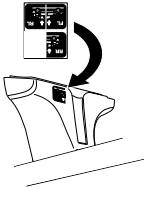

MITSUBISHI Challenger, 5-dr SUV, 96-05
MITSUBISHI L200 (MK 1), 4-dr Double Cab, 95-05
MITSUBISHI Montero Sport, 5-dr SUV, 96-06
MITSUBISHI Pajero Sport, 5-dr SUV, 96-05

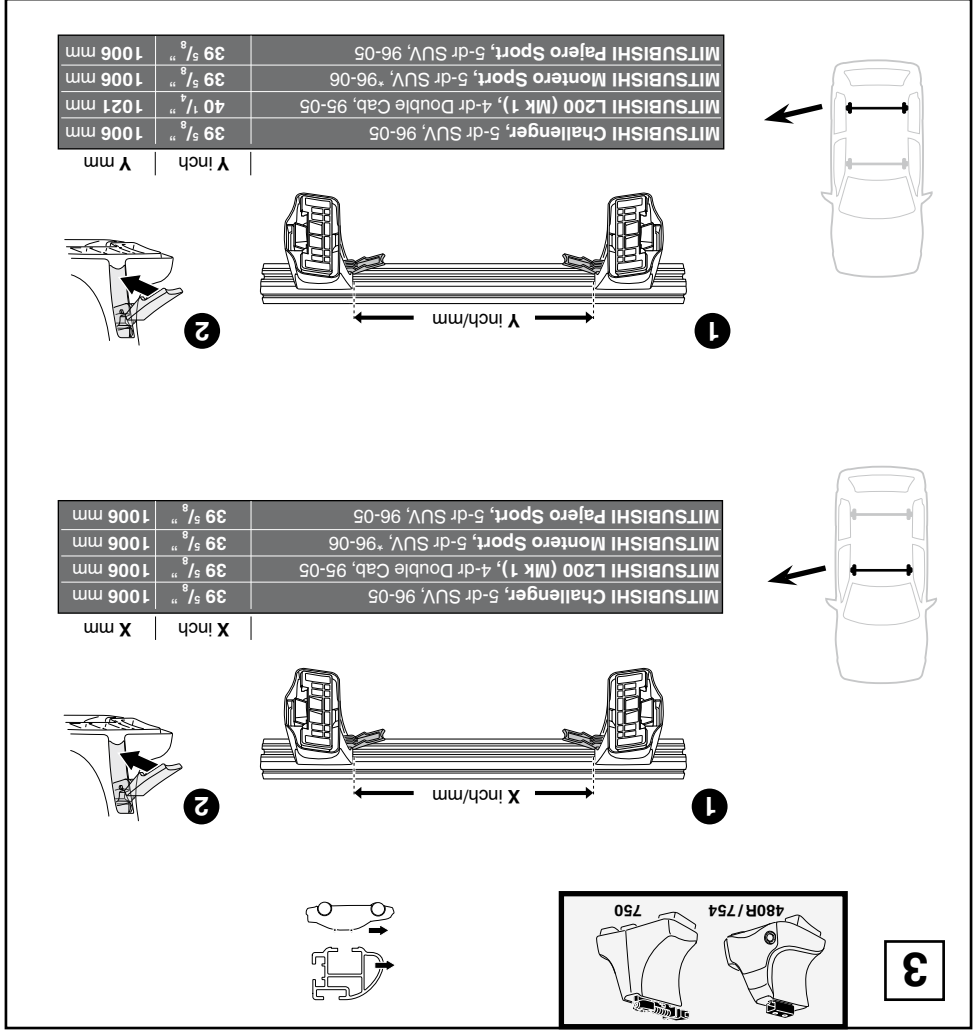
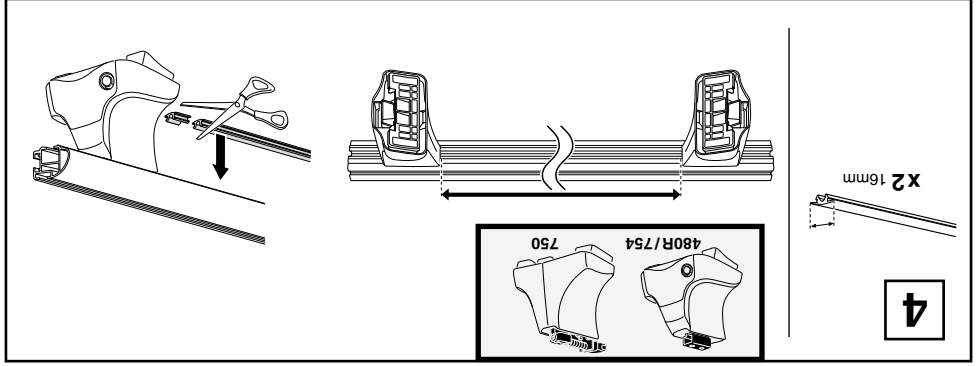

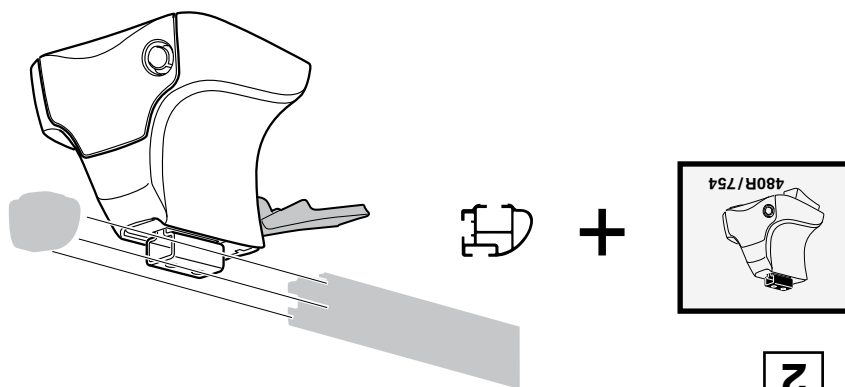
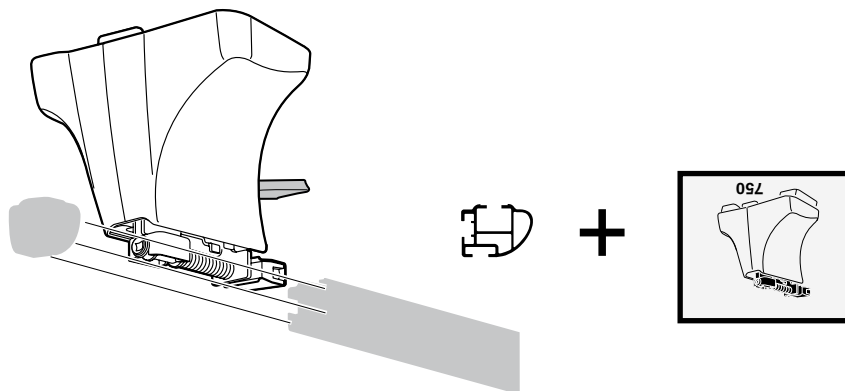

2

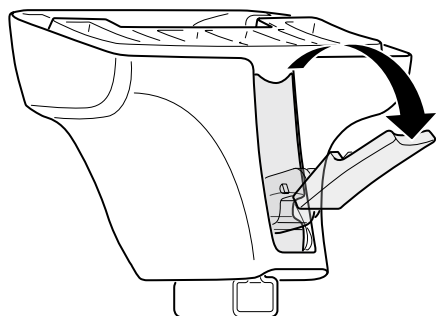

1

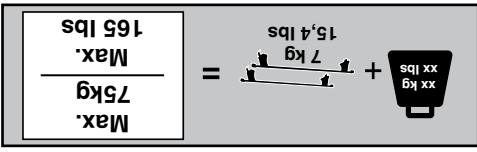
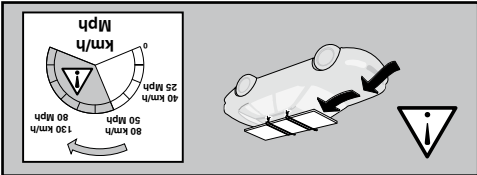
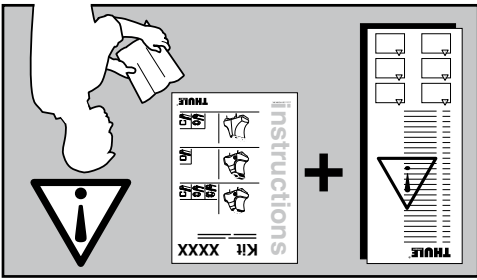
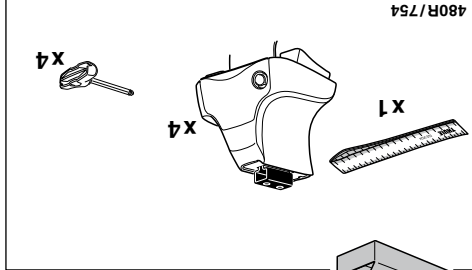
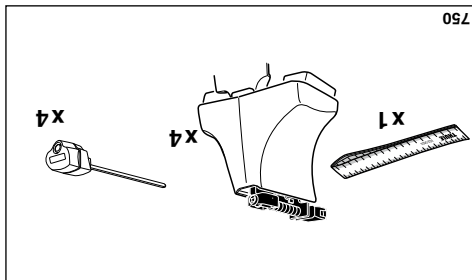
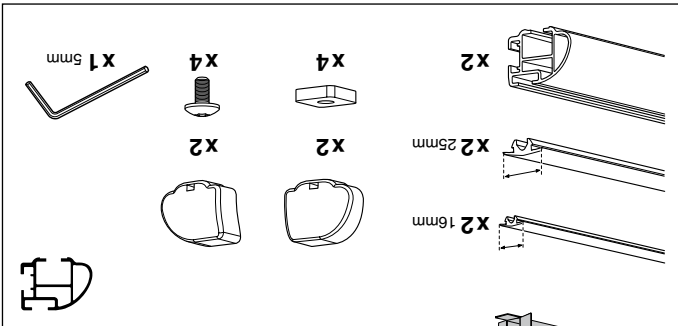
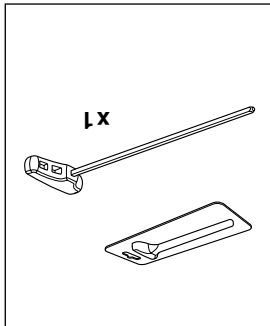
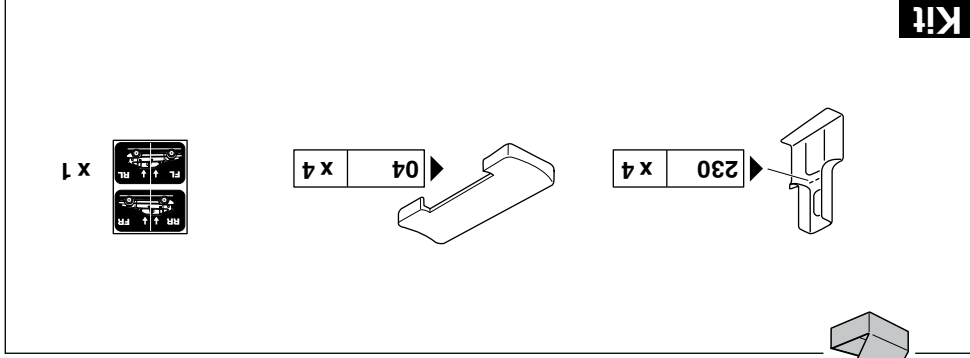

instructions

Kit 1236

MITSUBISHI Challenger, 5-dr SUV, 96-05
 MITSUBISHI L200 (Mk 1), 4-dr Double Cab, 95-05
 MITSUBISHI Montero Sport, 5-dr SUV, *96-06
 MITSUBISHI Pajero Sport, 5-dr SUV, 96-05
 *North America

480R
754

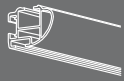
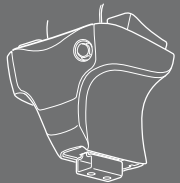

750

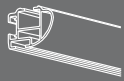
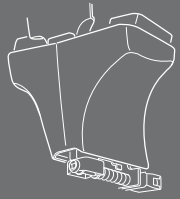

ISO 11154-E

THULE
 SWEDEN
 PROFESSIONAL