

# Kit 1050

VOLKSWAGEN Golf IV, 3-dr Hatchback, 98-03 / \*99-05

VOLKSWAGEN GTI IV, 3-dr Hatchback, \*99-06

VOLKSWAGEN Jetta IV, 3-dr Sedan, 98-04

\*North America

480R  
754

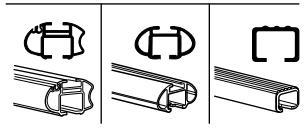
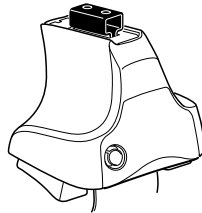

480

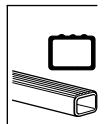
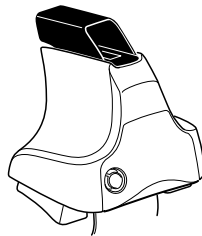

750

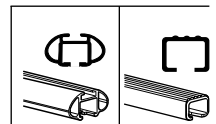
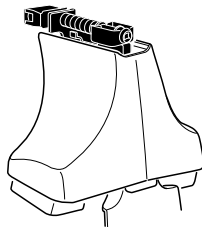

**Kit**



**3**

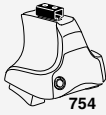

754

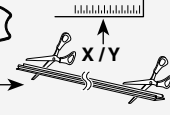

x / y

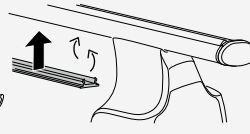

750



**1**

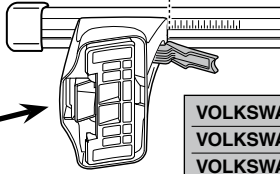
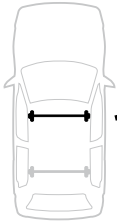

**2**

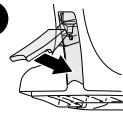

	X
VOLKSWAGEN Golf IV, 3-dr Hatchback, 98-03 / *99-05	27
VOLKSWAGEN GTI IV, 3-dr Hatchback, *99-06	27
VOLKSWAGEN Jetta IV, 3-dr Sedan, 98-04	27

**1**

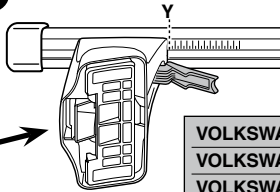

**2**

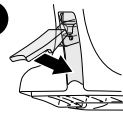

	Y
VOLKSWAGEN Golf IV, 3-dr Hatchback, 98-03 / *99-05	32
VOLKSWAGEN GTI IV, 3-dr Hatchback, *99-06	32
VOLKSWAGEN Jetta IV, 3-dr Sedan, 98-04	32



480R

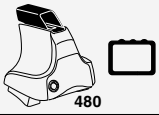

480

**1**

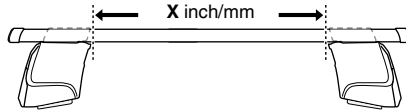
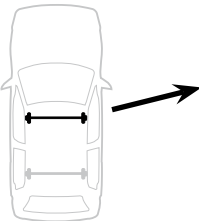

**2**

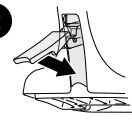

	X inch	X mm
VOLKSWAGEN Golf IV, 3-dr Hatchback, 98-03 / *99-05	36 1/4"	921 mm
VOLKSWAGEN GTI IV, 3-dr Hatchback, *99-06	36 1/4"	921 mm
VOLKSWAGEN Jetta IV, 3-dr Sedan, 98-04	36 1/4"	921 mm

**1**

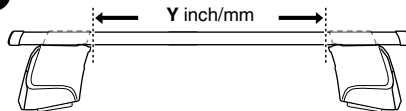
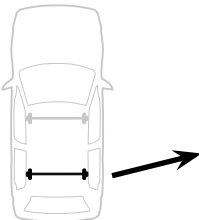

**2**

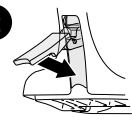

	Y inch	Y mm
VOLKSWAGEN Golf IV, 3-dr Hatchback, 98-03 / *99-05	38 1/4"	971 mm
VOLKSWAGEN GTI IV, 3-dr Hatchback, *99-06	38 1/4"	971 mm
VOLKSWAGEN Jetta IV, 3-dr Sedan, 98-04	38 1/4"	971 mm

# 4

VOLKSWAGEN Golf IV, 3-dr Hatchback, 98-03 / \*99-05

VOLKSWAGEN GTI IV, 3-dr Hatchback, \*99-06

VOLKSWAGEN Jetta IV, 3-dr Sedan, 98-04

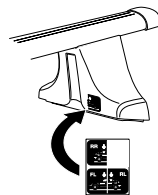
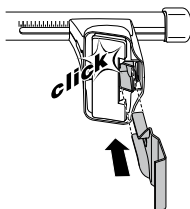
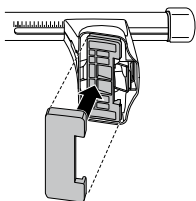
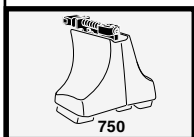
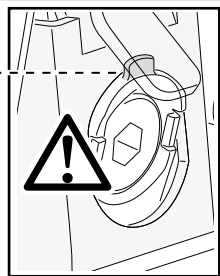
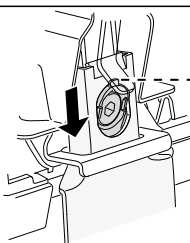
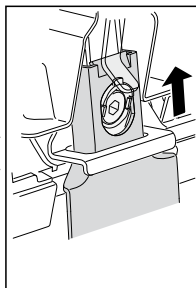
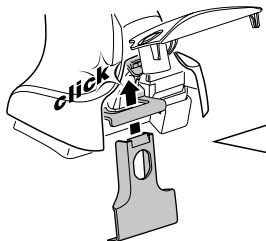
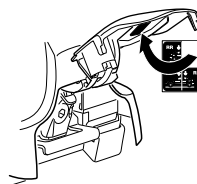
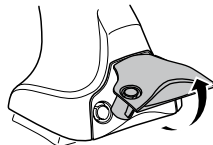
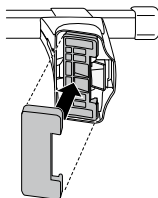
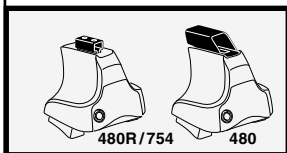
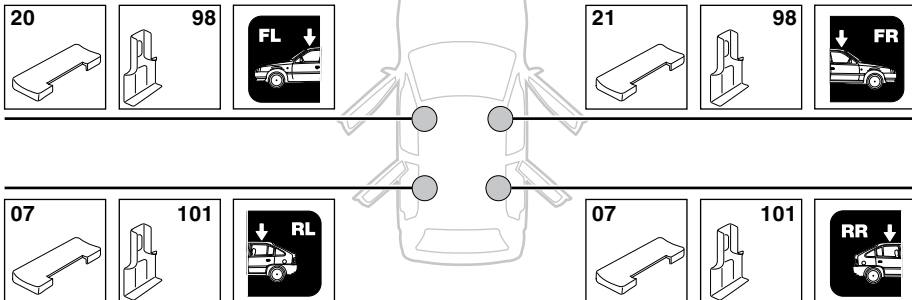

5

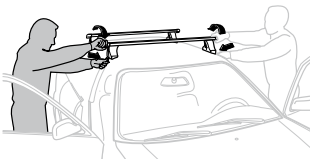
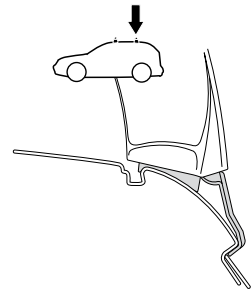
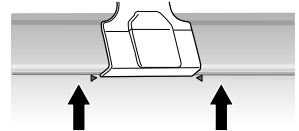
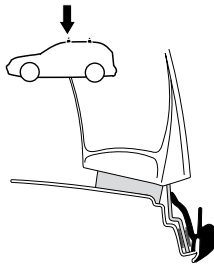
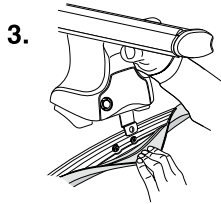
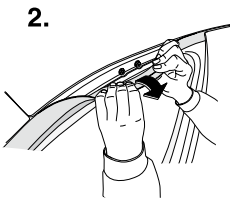
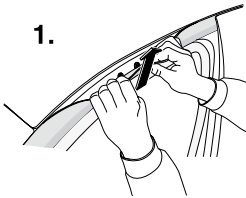
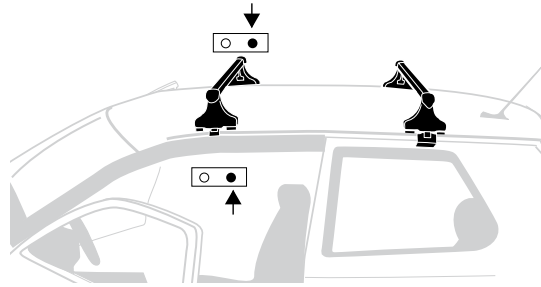
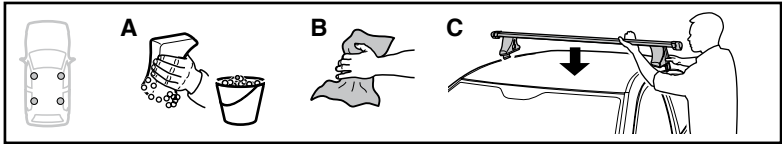

- GB/US** Tighten alternately  
**D** Die Schrauben abwechselnd anziehen  
**F** Serrer alternativement chaque côté  
**NL** Afwisselend aan de linker- en de rechterkant aandraaien  
**I** Alternare il serraggio delle viti  
**E** Apretar alternativamente  
**PT** Aperte alternadamente  
**S** Dra åt växelvis  
**FIN** Kierrä vuorotellen  
**EST** Pinguldage vaheldumisi  
**LAT** Pievelciet pamišus  
**LIT** Užsukinėkite pakaitomis  
**PL** Śruby dokręcaj naprzemiennie  
**RU** Затягивайте попеременно

- CZ** Pokręťta bagazníka dokręcaj dokręcaj naprzemiennie.  
**SK** Dofahujte striedavo.  
**SLO** Privijajte izmenično.  
**HR** Naizmjenično zategnite  
**HU** Egymástól függetlenül szorítandó  
**GR** Σφιγίγτε εναλλάξ  
**TR** Dönüşümüü sıkın

- 中文** 交替拧紧  
**한국어** 번갈아 가며 조이십시오.  
**日本語** 交互に締め付けてください。  
**ไทย** ชั้้นในแบบสลับ

6



480R/754



480

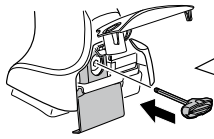

\*  
3 Nm



\*



\*  
≈ 3 Nm

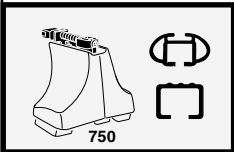

750

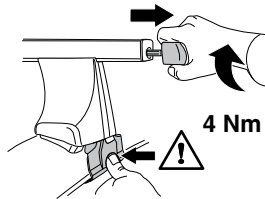

4 Nm

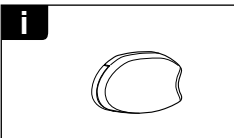
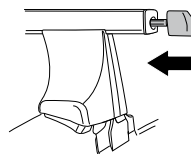

i

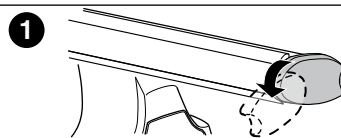

1

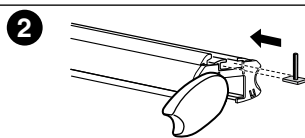

2

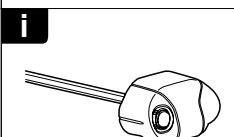

i

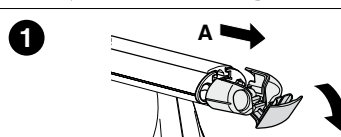

1

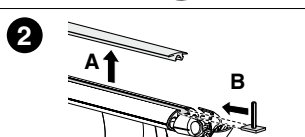

2

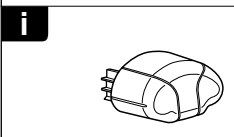

i

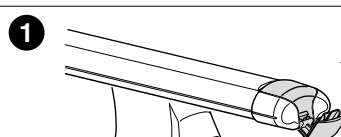

1

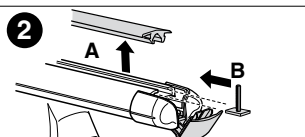

2

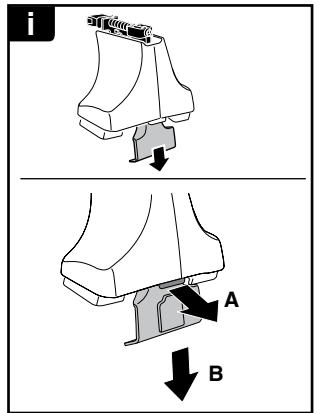
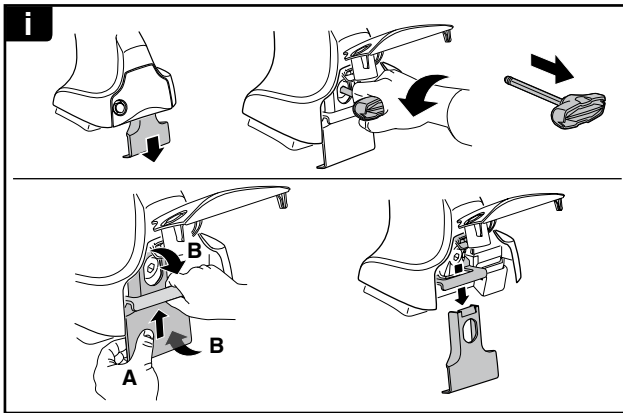
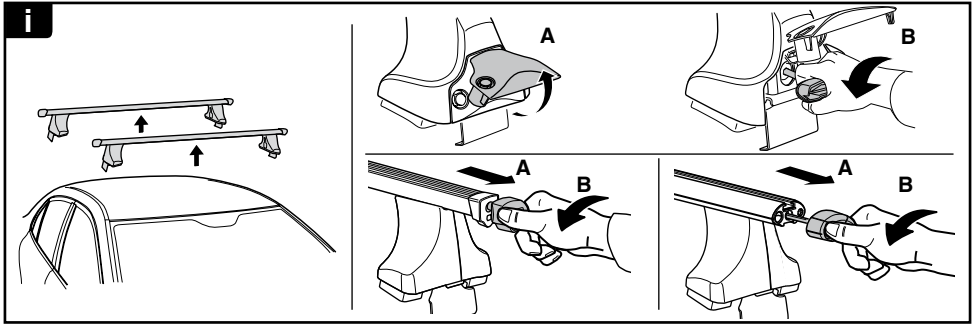

**THULE**  
SWEDEN  
**ONE  
KEY  
SYSTEM**



- 544 (x4)
- 596 (x6)
- 588 (x8)
- NA 510 (x10)
- EUR 452 (x12)
- ASIA



WW ▶ Thule Sweden AB, Box 69, 330 33 Hillerstorp, SWEDEN  
NA ▶ Thule Inc., 42 Silvermine Road, Seymour, Connecticut 06483, USA

info@thule.com  
customer.service@thule.com

www.thule.com