

Kit 3045

RENAULT Master (Mk.II), 4/5-dr Van, 98-03, 04-10

OPEL Movano (Mk.II), 4/5-dr Van, 98-03, 04-10

NISSAN Interstar (Mk.II), 4/5-dr Van, 02-10

This Kit is only for vehicles with fixpoint mounting.

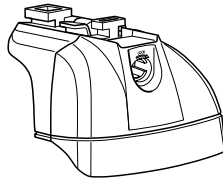

460R
753

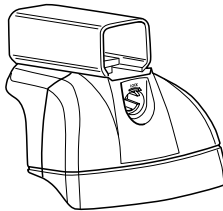
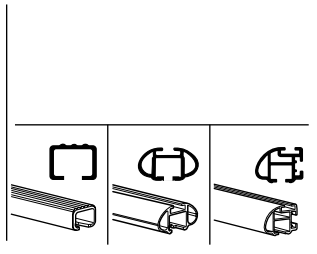

460

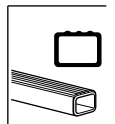

6 kg / 13 lbs + xx kg / xx lbs =

Max. 100 kg
Max. 220 lbs

9 kg / 20 lbs + xx kg / xx lbs =

Max. 150 kg
Max. 330 lbs

12 kg / 26 lbs + xx kg / xx lbs =

Max. 200 kg
Max. 440 lbs

80 km/h / 50 Mph 130 km/h / 80 Mph

40 km/h / 25 Mph

km/h
Mph

A **B** **C**

09 x 4

66 x 4

50969

50 mm x 8

x 8

x 8

x 8

x 8

x 1

Kit



753



x4



x4



x4



x8

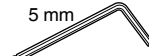

x1



x4



x1

460R



x4



x4



x4



x8

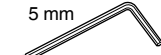

x1



x4

460



x4



x4



x4



x8

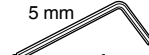

x1



x4



x2



x1

17 mm



x2

23 mm



x2

23 mm



x2



x2

17 mm

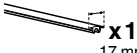

x2

23 mm

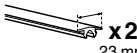

x2

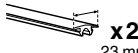

x2

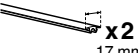
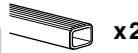

x2

25 mm

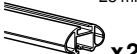

x2



x4

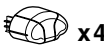

x4



x4



x2

x2



x4

x4

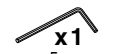

x1

5 mm

1



753/460R

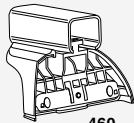

460

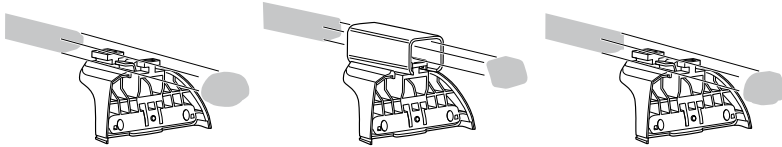

x4

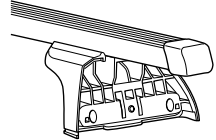
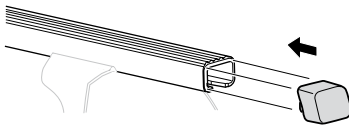

x4

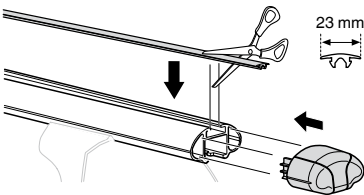

23 mm

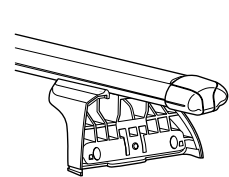
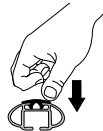

x4

x4

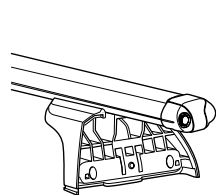
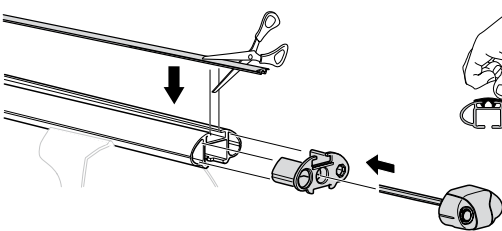

x4

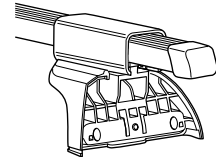
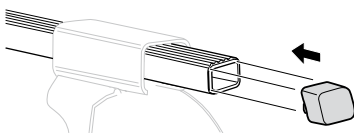

x2

x2

x4

x4

x1
5 mm

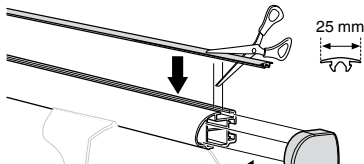

25 mm

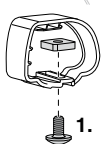
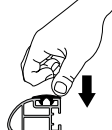

1.

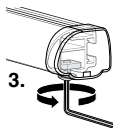

3.

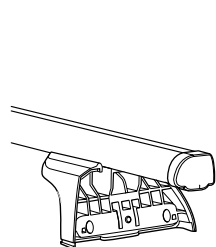

2

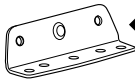

09 x 4

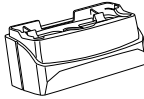

66 x 4

16 mm x 8



x 1

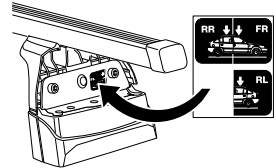
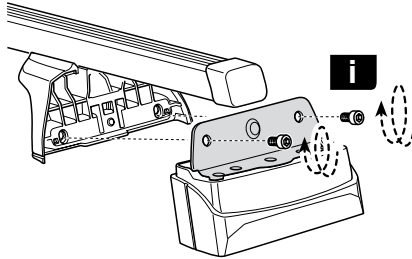
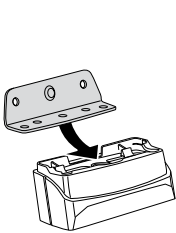
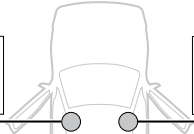
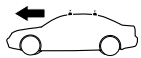

i

GB Only a few turns
D Nur wenige Umdrehungen
F Quelques tours uniquement
NL Slechts enkele slagen
I Solo qualche giro
E Sólo algunas vueltas
PT Noções básicas
S Endast några varv
FIN Vain muutama kierros

EST Ainult mõni pööre
LAT Tikai dažī apgriezieni
LIT Tik keli pasukimai
PL Wystarczy kilka obrotów
RU Достаточно нескольких оборотов
CZ Pouze několik otáček
SK Len niekoľko otáčok
SLO Le nekaj obratov

HR Samo nekoliko okreta
HU Csak néhány fordítás
GR Μόνο μερικές στροφές
TR Yalnız birkaç kez çevirm
中文 只有几个转向
한국어 두 세번만
日本語 数回転のみ
ไทย หมุนเพียงไม่กี่รอบ

!

GB If there is an interior roof lining, remove it before starting the installation procedure.
D Vor Montagebeginn muß ggf. das Innendach gelöst werden.
F Si l'habitacle comporte un pavillon séparé, le déposer avant de commencer le montage.
NL Als er een binnendak aanwezig is, maak dit dan los voordat u met de montage begint.
I Rimuovere l'eventuale modanatura interna del tetto prima di iniziare la procedura di installazione.
E Si hay un techo interior, soltarlo antes de empezar el montaje.
S Om det finns ett inmertak, lossa detta innan monteringen påbörjas.
FIN Jos autossa on sisäkatto, irrota se ennen asennuksen aloittamista.
EST Kui eksisteerib sisemine katusevooderdis, eemaldage see enne paigaldamisega alustamist.
PL Przed rozpoczęciem montażu usunaj ewentualną spodnią część dachu samochodu.
RU В случае наличия на крыше декоративных накладок, перед началом установки их необходимо снять
CZ V případě, že vozidlo je vybaveno vnitřním stropem musí být tento před montáží odmontován.
SLO Pred pritrjevanjem odstranite notranjo strešno oblogo, če jo vozilo ima.
HU Abban az esetben ha a rögzítés helyén belső közbetétet találunk, azt a rögzítés előtt távolítsuk el.
한국어 내부 루프 라이닝이 있는 경우, 설치를 시작하기 전에 분리하십시오.
日本語 内側に屋根の裏張りがある場合は、取付手順を開始する前に取り外してください。

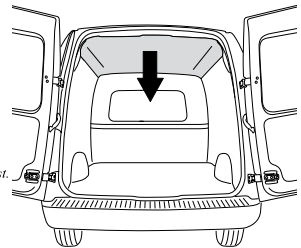

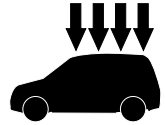
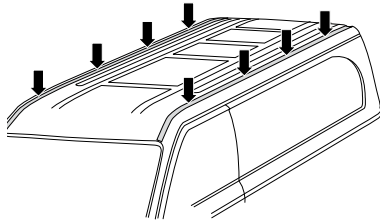
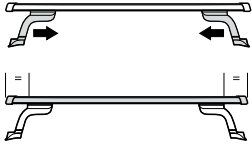
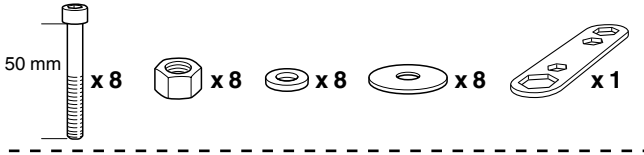
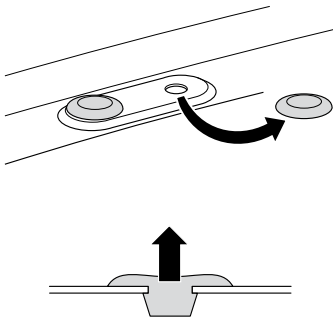
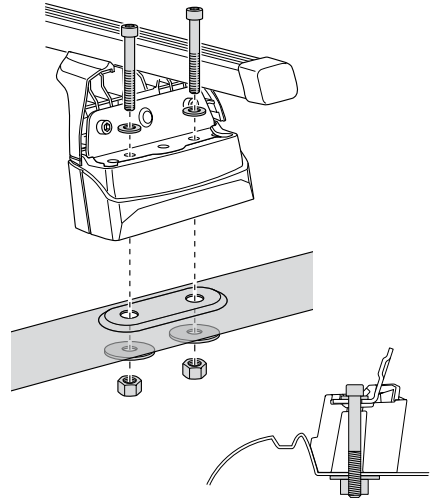
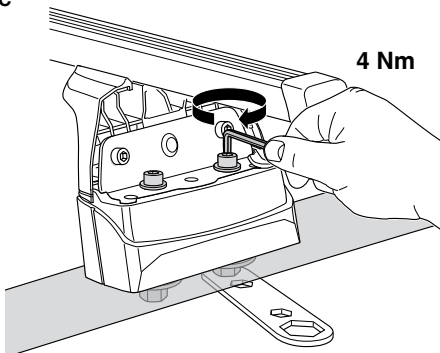
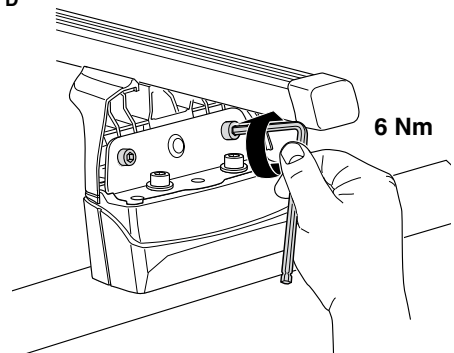
3**A****B****C****D**

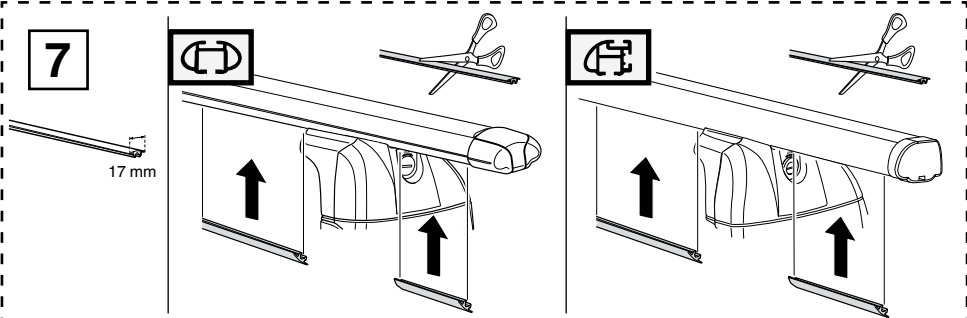
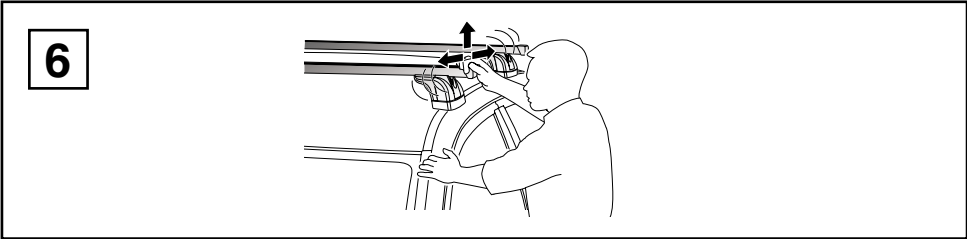
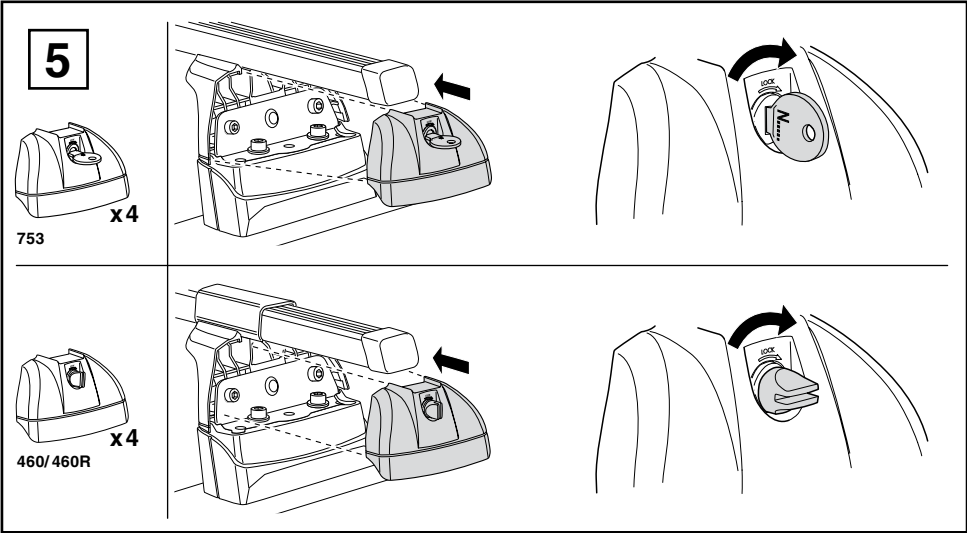
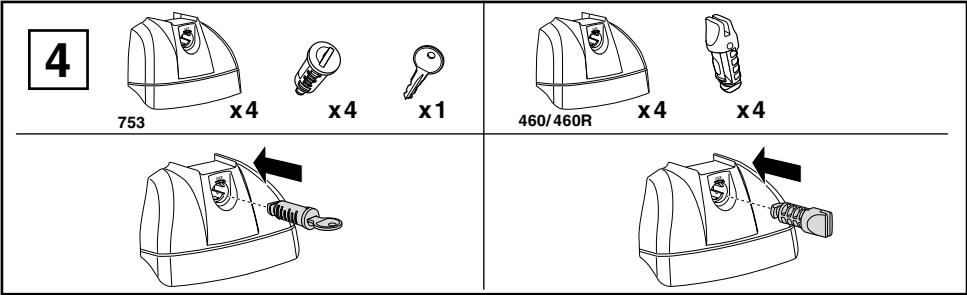

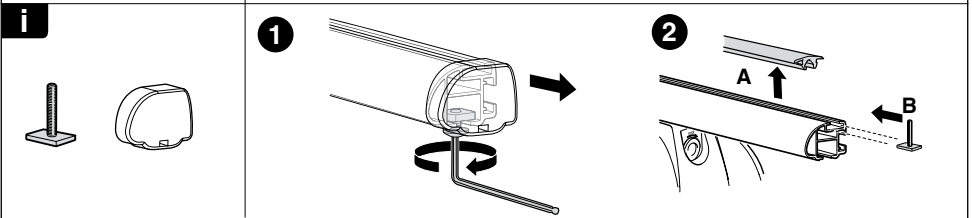
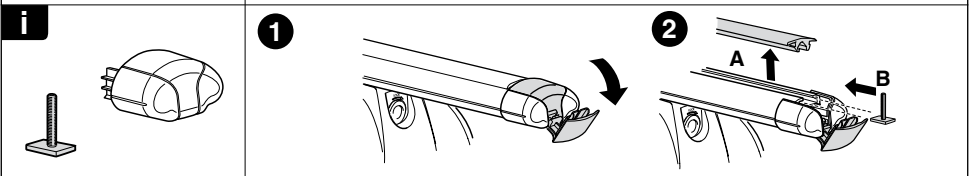
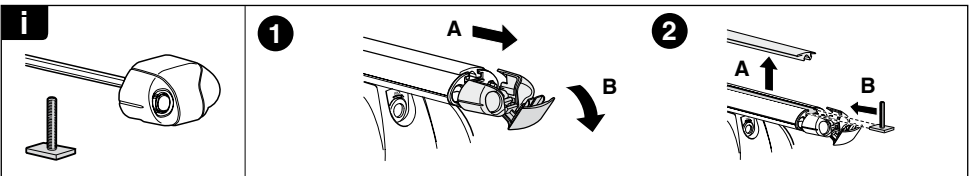
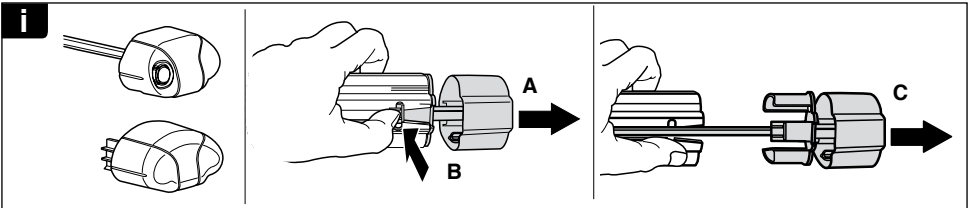
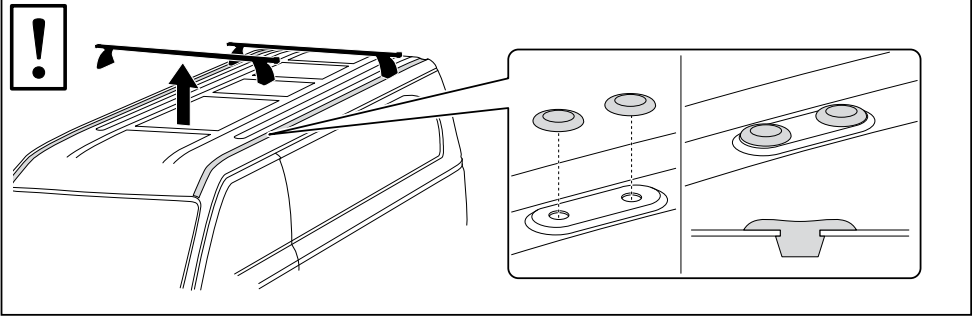

THULE
SWEDEN
**ONE
KEY
SYSTEM**

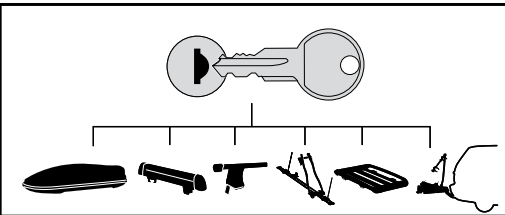

- 544** (x4)
- 596** (x6)
- 588** (x8)
- 510** (x10)
- 452** (x12)