

➤ Instructions

Thule FreeRide 532



EN Roof-mounted bike carrier
DE Dachfahrradträger
FR Porte-vélo sur le toit
NL Fietsdrager voor op het dak
IT Portabici da installare sul tetto
ES Portabicicletas de techo
PT Suporte para bicicleta para teto
SV Takmonterad cykelhållare
DK Tagmonteret cykelholder
NO Takmonterte lasteholdere
FI Katolle asennettava polkupyöräteline
ET Katusele paigaldatav jalgrattahoidik
LV Uz jumta uzstādāms velosipēdu turētājs
LT Ant stogo tvirtinami dviračių laikikliai
PL Bagażnik rowerowy montowany na dachu
RU Устанавливаемое на крыше крепление для велосипедов
UK Багажник для велосипедів, що монтується на даху
BG Покривен багажник за велосипеди
CS Nosič jízdních kol s montáží na střechu
SK Nosič bicyklů s montážou na strechu
SL Nosilec za kolesa
HR/BIH Krovni nosač bicikla

RO Suport pentru bicicletă montat pe pavilion
HU Tetőre szerelhető kerékpártartó
EL Σχάρα ποδηλάτου οροφής
TR Araç üstüne bağlanan bisiklet taşıyıcı
ZH 頂置自行車架
JA ルーフマウント型サイクルキャリア
KO 지붕 장착 자전거 캐리어
TH โครงยึดจัดจักรยานแบบติดตั้งบนหลังคา

מנשא אופניים המורכב על גג המכונית
 حامل الدراجة للتثبيت على السقف

HE
AR

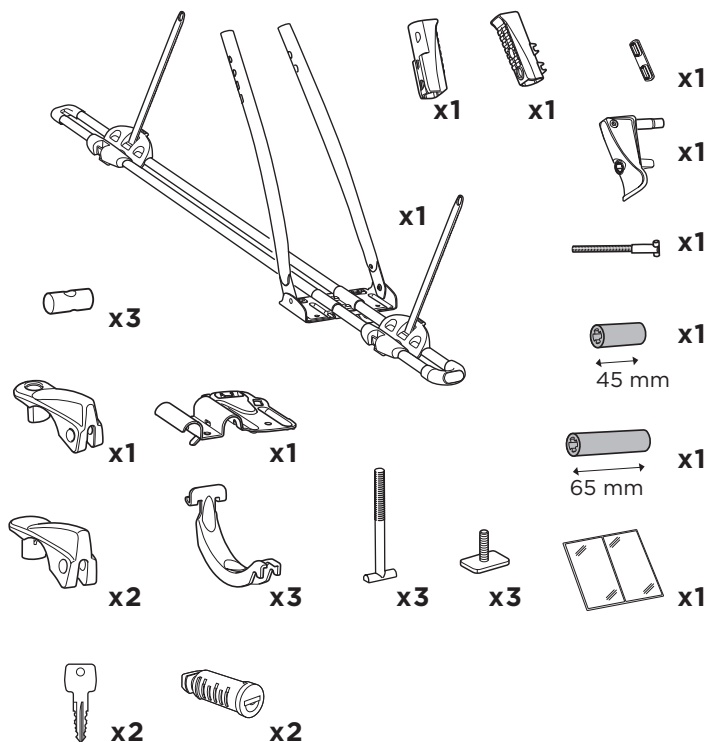
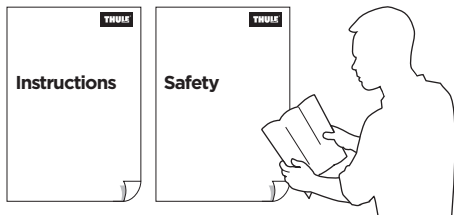

i



Thule WingBar Evo

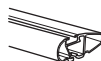

Thule WingBar

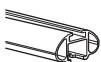

Thule AeroBar



Thule SlideBar

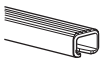

Thule SquareBar

i

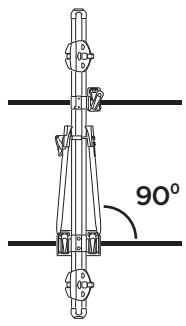
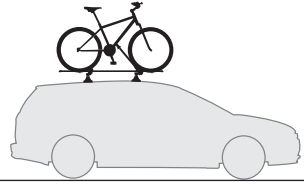
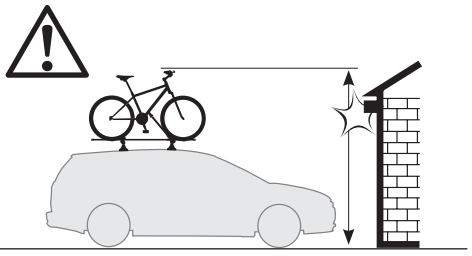
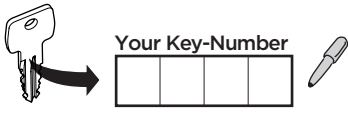

3.5 kg



= Max 17 kg

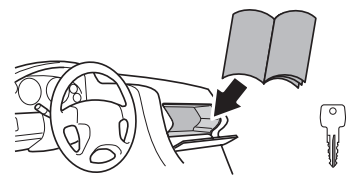

1

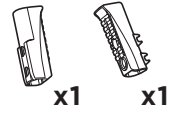
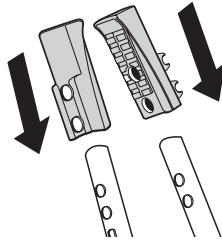

2

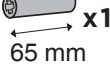
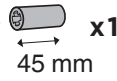

$\varnothing 22 - 58 \text{ mm}$

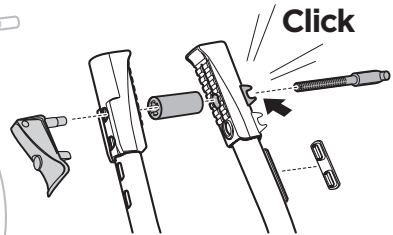
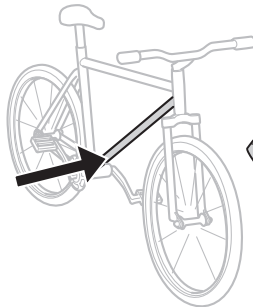

$\varnothing 59 - 70 \text{ mm}$
Max
65 x 80 mm

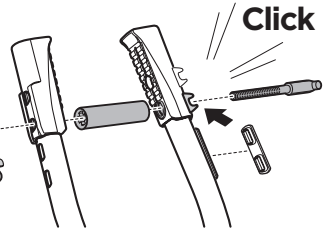
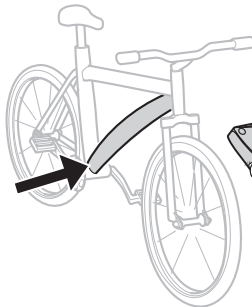

3

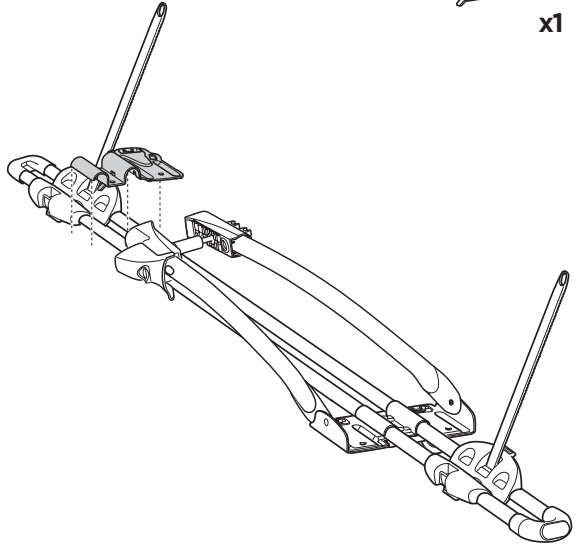
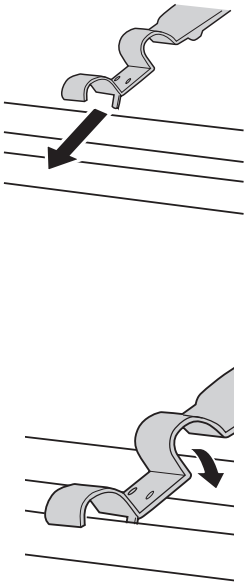

4

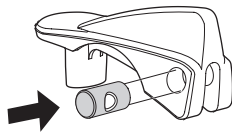
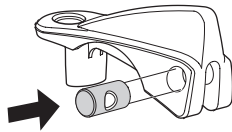

5

i



Thule WingBar Evo

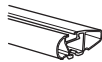

Thule WingBar



x1



x3

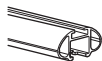

Thule AeroBar



Thule SlideBar



x2

A

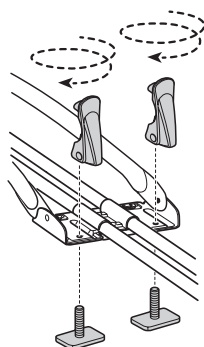
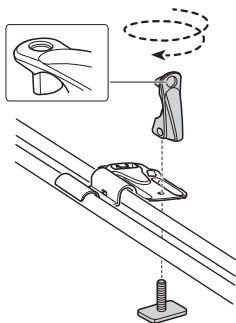

B

i



THULE WingBar Evo

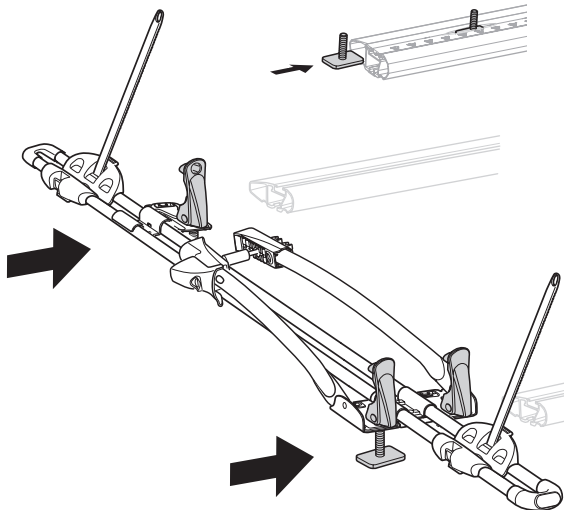
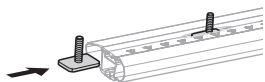

C

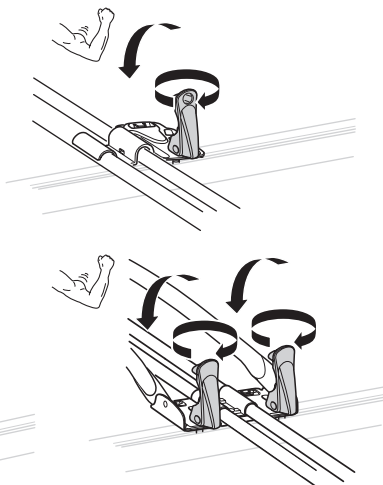

5

i

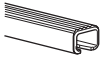

Thule SquareBar



x1



x3

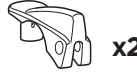

x2



x3

A

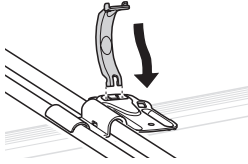

B

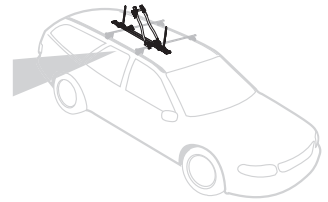
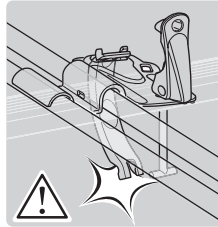
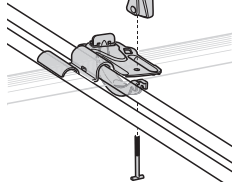

C

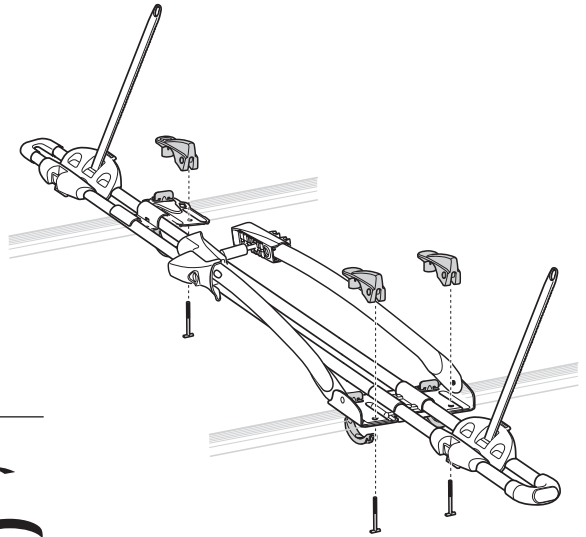
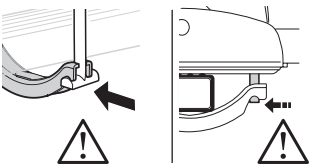

D

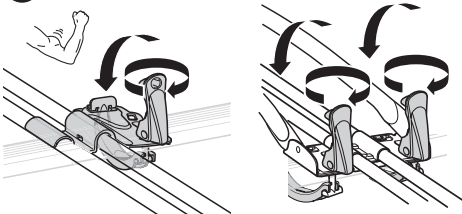

6

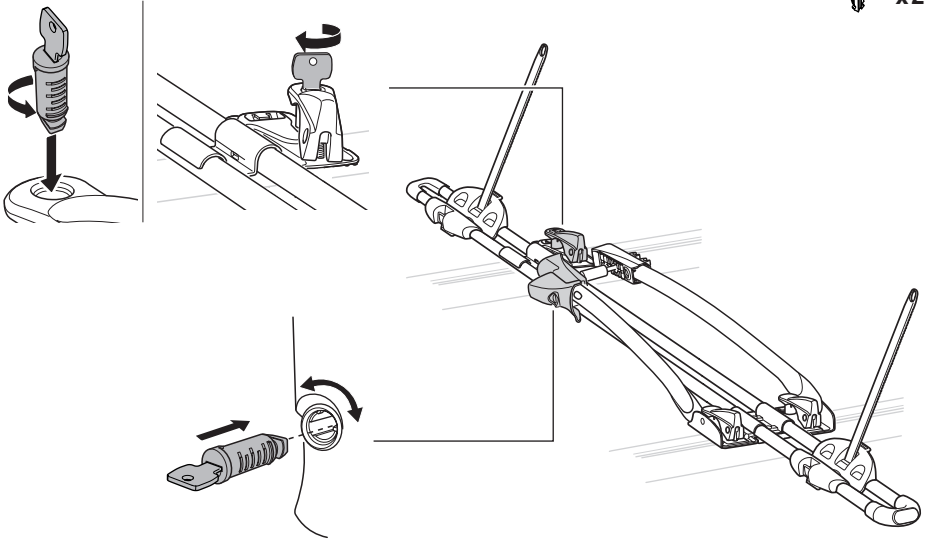

7

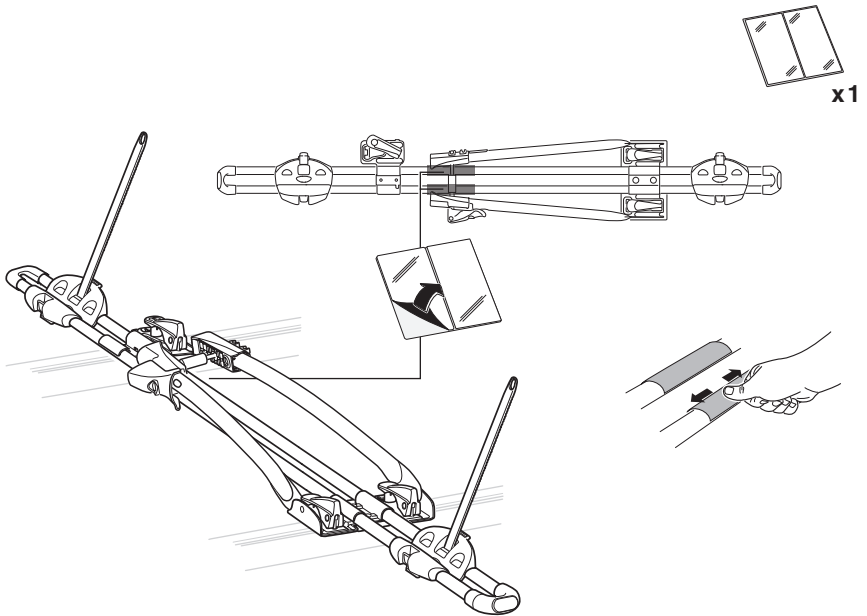

8

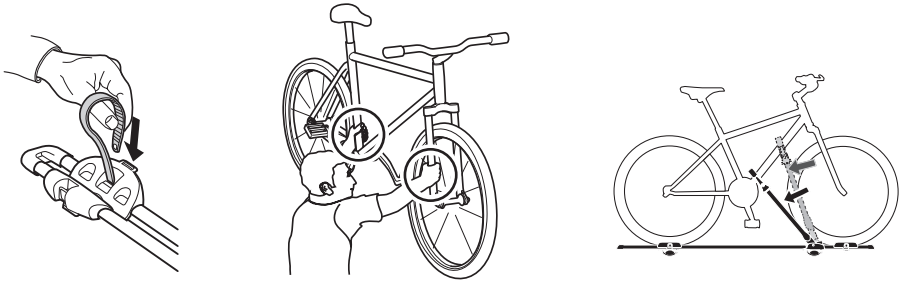

9

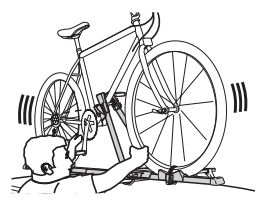
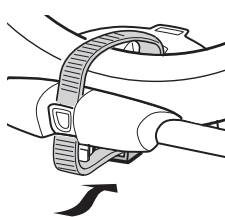
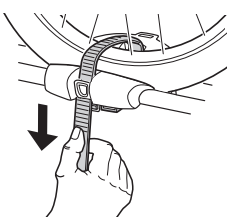
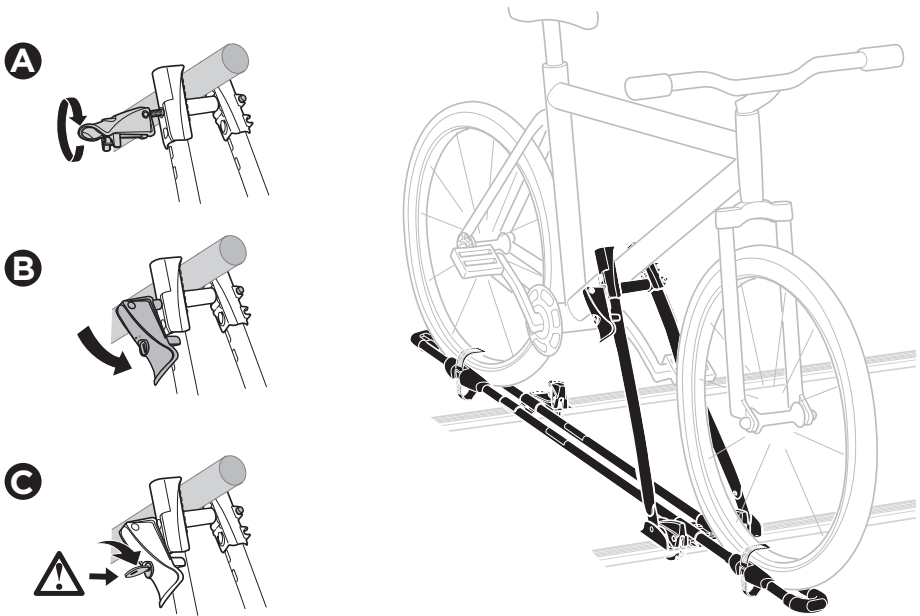

EN	Left-hand fitting	UK	Установка на ліву сторону		
DE	Montage links	BG	Монтаж отляво		
FR	Montage côté gauche	CS	Montáž z levé strany		
NL	Montage aan de linker kant	SK	Montáž na ľavej strane		
IT	Montaggio a sinistra	SL	Pritrjevanje z leve strani		
ES	Montaje a izquierda	HR/BIH	Montaža s lijeve strane		
PT	Montagem do lado esquerdo	RO	Montare pe partea stângă		
SV	Vänstermonterad	HU	Bal oldalról szerelhető		
DK	Venstremontering	EL	Τοποθέτηση αριστερά		
NO	Venstremontering	TR	Sol elle montaj		
FI	Asennus vasemmalle			התקנה שמאלית	HE
ET	Vasakpoolne kinnitamine			التركيب في الجانب الأيسر	AR
LV	Kreisais stiprinājums	ZH	从左侧安装		
LT	Kairysis pritvirtinimas	JA	左手装着		
PL	Montaż z lewej	KO	왼손 장착		
RU	Установка на левую сторону	TH	ตัวยึดด้านซ้ายมือ		

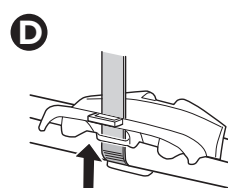
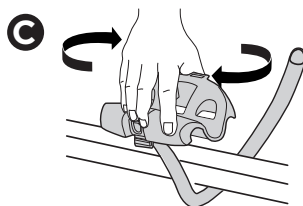
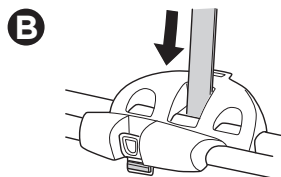
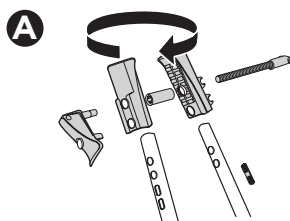
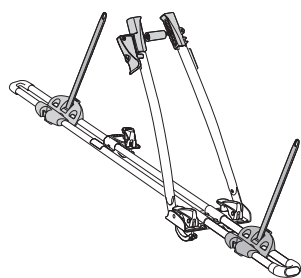

EN Accessories	DK Tilbehør	UK Аксессуары	EL Εξαρτήματα
DE Zubehör	NE Tilbehør	BG Принадлежности	TR Aksesuarlar
FR Accessoires	FI Lisävarusteet	CS Doplňky	الملحقات AR
NL Accessoires	ET Lisavarustus	SK Príslušenstvo	אביזרים HE
IT Accessori	LV Piederumi	SL Dodatki	ZH 附件
ES Accesorios	LT Priedai	HR/BiH Dodaci	JA アクセサリー
PT Acessórios	PL Akcesoria	RO Accesorii	KO 액세서리
SV Tillbehör	RU Аксессуары	HU Tartozékok	TH อุปกรณ์เสริม

Thule One-Key System

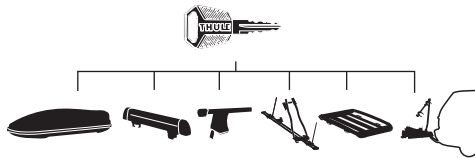

450400  (x4)

450600  (x6)

450800  (x8)

451200  (x12)

451600  (x16)

Thule Adapter 889-3

