

1

Kit 5020

FORD Mondeo (Mk. V), 5-dr Hatchback, 15-

ISO 11154-E

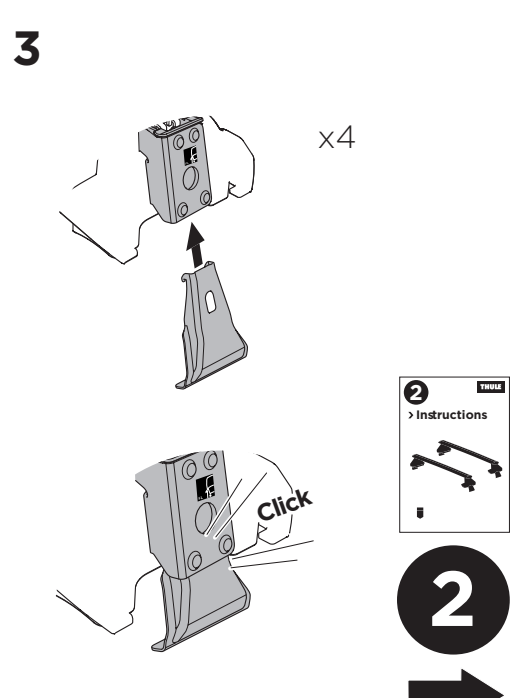
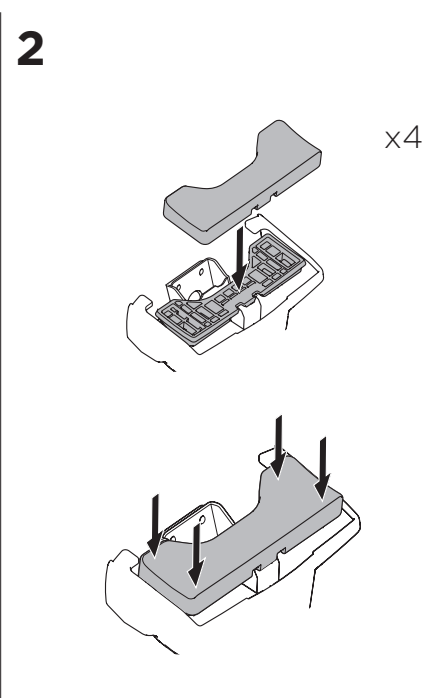
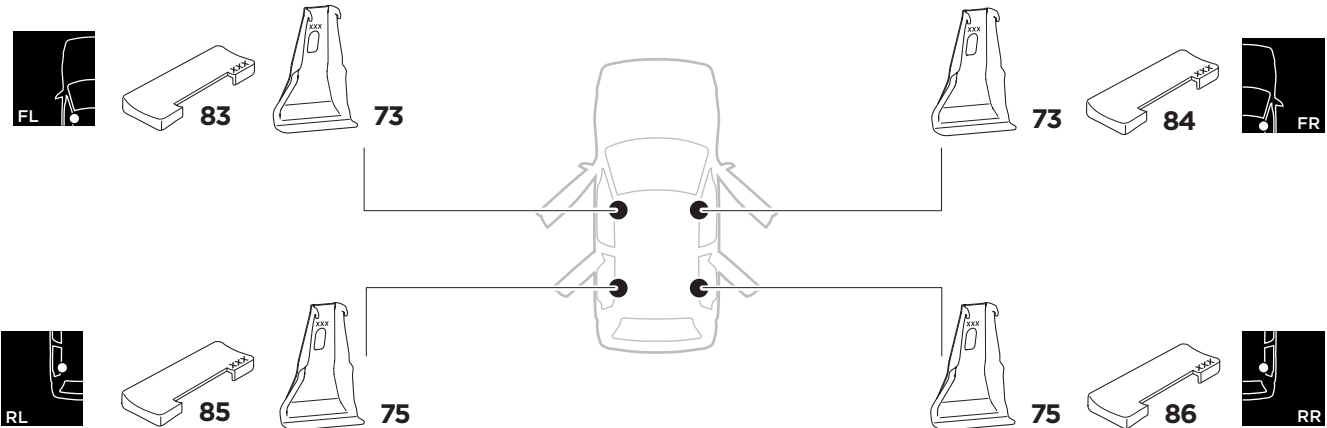
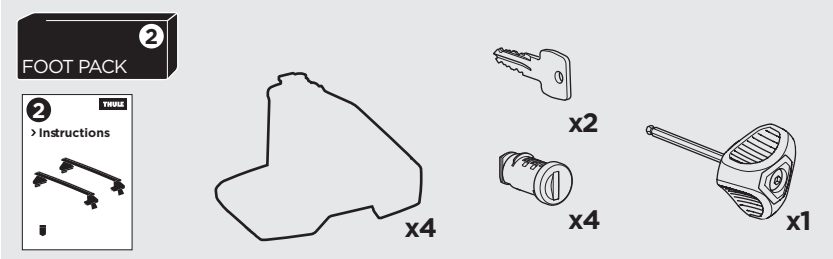
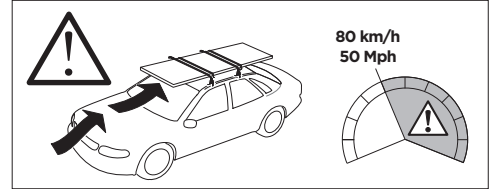
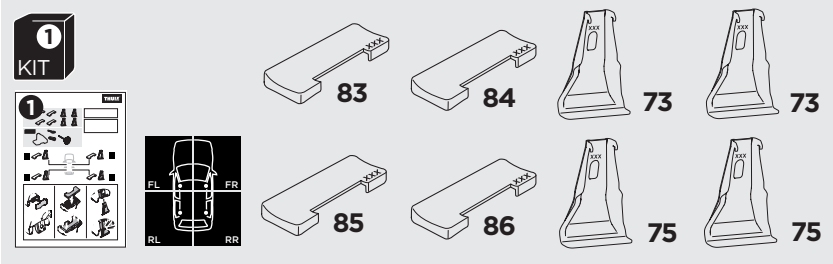



THULE WingBar Evo	THULE WingBar Edge	THULE WingBar	THULE SquareBar	Evo X (scale)	Edge X (scale)
FORD Mondeo (Mk. V), 5-dr Hatchback, 15-				45,5	F
THULE ProBar	THULE SlideBar				X (mm/inch)
FORD Mondeo (Mk. V), 5-dr Hatchback, 15-				1106 mm / 43 1/2"	



THULE WingBar Evo	THULE WingBar Edge	THULE WingBar	THULE SquareBar	Evo Y (scale)	Edge Y (scale)
FORD Mondeo (Mk. V), 5-dr Hatchback, 15-				44	I
THULE ProBar	THULE SlideBar				Y (mm/inch)
FORD Mondeo (Mk. V), 5-dr Hatchback, 15-				1091 mm / 43"	

	W (mm/inch)	Z (mm/inch)
FORD Mondeo (Mk. V), 5-dr Hatchback, 15-	780 mm / 30 3/4"	230 mm / 9"

