























709372: C. Nemo, F. Fiorino, P. Bipper 02/2008 -

A (1x)  13 pin mech.	B (1x) 	C (1x) 	D (1x) 	E (1x) 	F (1x)  Ø 25 mm	G (2x)  colour chart		
K (4x) 	L1 (3x)  M5 x 35	L2 (3x)  M5	R (1x) 	S (1x) 	T (1x)  080-0020-1006	H (2x) 	J2 (2x)  L = 160	J1 (3x)  L = 290
M1 (1x)  M6 x 10	M2 (1x)  M6	Q (12x)  L = 100	U (1x) 	V (1x)  15 A				
N (3x)  026-0000-0212	P (1x)  M6	2x 027-0040-0002						

- NL Algemene richtlijnen voor montage
- DK Almene oplysninger
- D Allgemeine Hinweise zur Montage-Erleichterung
- FR Directives générales pour faciliter le montage
- S Allmänna Instruktioner
- GB General instructions
- SF Yleisiä ohjeita

- ES Directorios generales para la asamblea
- I Istruzioni generali
- GR Γενικές οδηγίες για τη συνέλευση
- HUN Használati útmutató
- SK Uživatelská príručka
- PL Ogólne polecenia
- PU Diretrizes orientadoras gerais para o conjunto

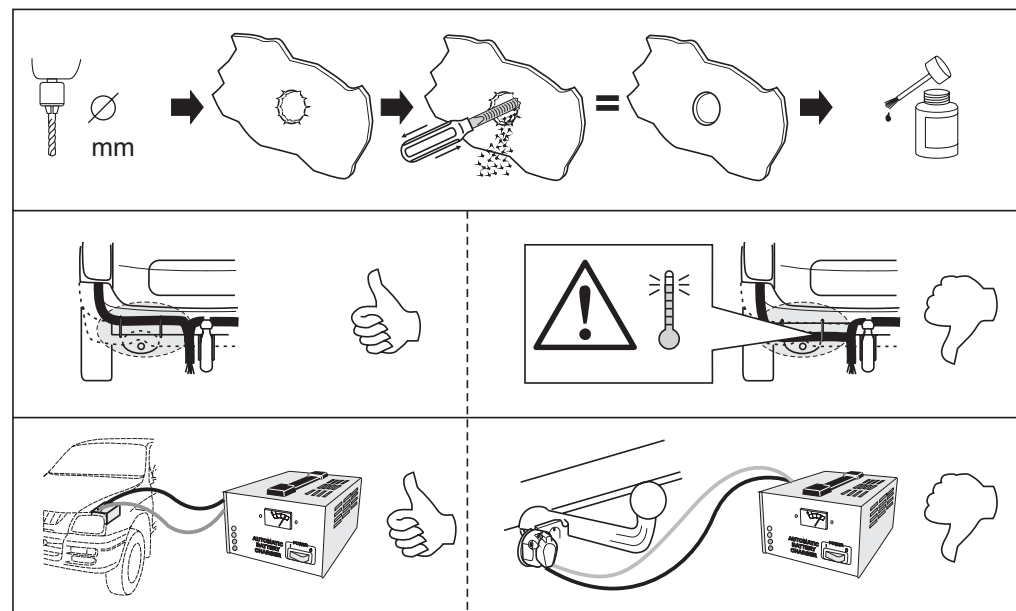

ROUTING

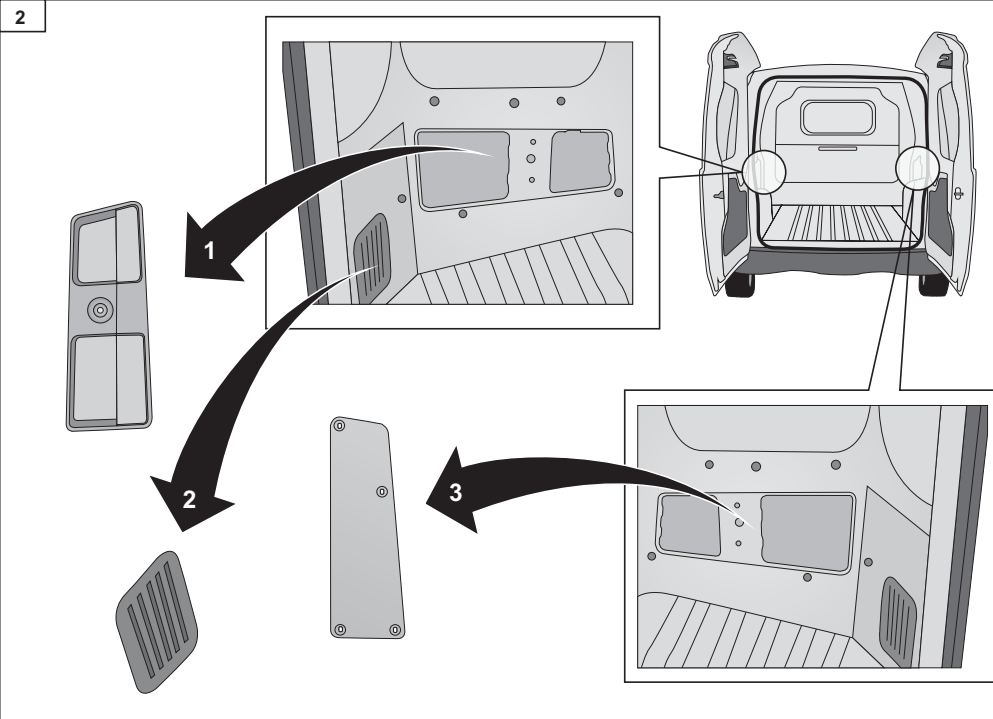
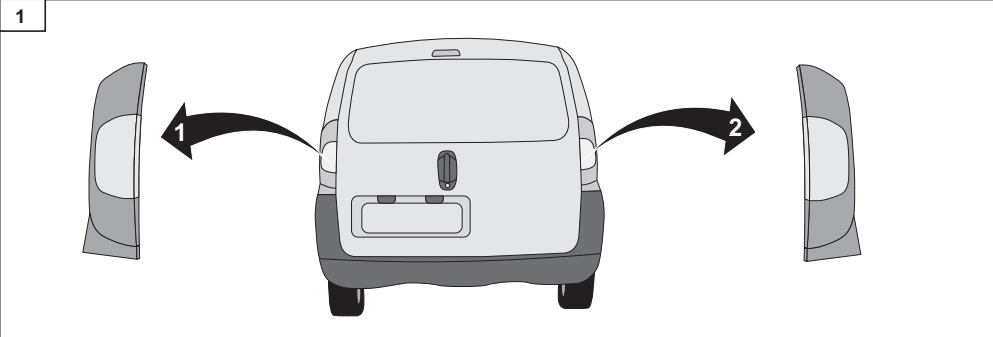
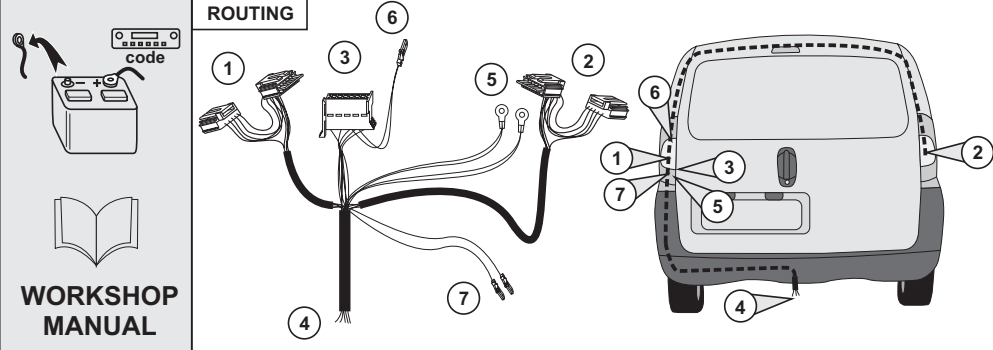

<p>15</p> <p>TEST ← ⚡ → ⚡ stop ⚡ H_R</p>	
<p>16</p> <p>TEST ← ⚡ → ⚡ stop ⚡ L H_R</p>	
<p>17</p> <p>TEST ⚡</p>	
<p>18</p> <p>Tester lamp</p> <p>Tester L.E.D.</p>	<p>19</p> <p>MANUAL</p> <p>OWNERS MANUAL</p>

